



Installation instructions

Akrapovič Product:
Rear Wing (Carbon)
for the
BMW M2 (type G87)

ENGLISH
Version 1.0

09/2023



www.akrapovic.com

D251.1.00.0000 A



Installation instructions

Akrapovič Product:
Rear Wing (Carbon)
for the
BMW M2 (type G87)

ENGLISH
Version 1.0

09/2023

www.akrapovic.com

D251.1.00.0000A

Congratulations on purchasing the Akrapovič product. The Akrapovič product is made by Akrapovič d.d., Malo Hudo 8a, 1295 Ivančna Gorica, Slovenia ("Akrapovič").

Please read this entire installation manual carefully prior to installing and using the Akrapovič product.

Akrapovič product should only be installed by persons skilled in vehicle parts installation and performance. The instructions provided in this manual should be followed to ensure proper installation and safe use of the Akrapovič product. Akrapovič and/or its partners shall not be held liable for any damage or personal injury (including direct, indirect, or consequential damage) sustained as a result of improper installation of the Akrapovič product or its use and maintenance contrary to the instructions and warnings contained herein.

If you have any questions regarding the installation and/or proper use of the Akrapovič product or this manual, please contact your local Akrapovič partner.

For more information on the Akrapovič products, see the official Akrapovič website at: <http://www.akrapovic.com>

GENERAL INFORMATION

Your safety is our number one priority. Please drive responsibly, safely and always obey local traffic rules.

All statements made with regard to the product's compliance are made in respect of the product "as is". Any modifications of the Akrapovič product or its improper installation, use or maintenance that is not in accordance with this Installation manual, may result in severe damage to the product, vehicle and/or engine, as well as personal injury, and may affect the product's compliance with the legal requirements, such as product's air and/or noise emissions (as an example, the vehicle may not be suitable for use on public roads any longer), as well as warranty coverage.

The product may only be used in accordance with relevant laws and regulations, including state and federal, where applicable.

Damage caused by improper installation, use and maintenance of the Akrapovič product is not covered by the Akrapovič warranty. Please refer to the enclosed warranty with regard to the terms of our warranty.

Technical specifications of Akrapovič products are subject to change without notice.

COPYRIGHT AND OTHER RIGHTS NOTICE

The Akrapovič trademark, including corporate logos and emblems, are subject to copyright as well as trademark rights of Akrapovič, its licensors, or third persons authorizing Akrapovič to use them.

Any reproduction, technical or other manipulation, translation, or other use of the copyright and/or trademark rights contained herein is prohibited without the explicit prior written consent of Akrapovič. The same especially applies to the entire contents of this manual and/or any of its parts, including but not limited to technical specifications, instructions, graphs, photographs, and so on included in this manual.

The shape of the Akrapovič products is protected under a registered Community Design No.RCD 015000938-0001.

Akrapovič takes all copyright and other rights infringement cases under serious consideration. If you have any reason to believe that your product is not an original Akrapovič product, please contact our local partners or Akrapovič at info@akrapovic.com.

SAFETY AND COMPLIANCE WARNING, PLEASE READ CAREFULLY

BEFORE REMOVING THE STOCK PARTS AND BEGINNING THE INSTALLATION OF YOUR NEW AKRAPOVIČ PRODUCT, PLEASE MAKE SURE THAT ALL ITEMS LISTED BELOW ARE VERIFIED:

- This manual is specific to the product's application on the vehicle indicated on the cover page, for which it is designed. Installation procedures vary depending on the type of vehicle. Please verify that the Akrapovič **product and this installation manual correspond to the type of your vehicle.**
- Make sure the vehicle is **securely positioned to prevent** damage to yourself and others, the vehicle or other items.
- Please check the parts you received against the parts list available on our website (please use the QR code on the front page or look for "schematic view" in the respective product page on www.akrapovic.com). Make sure that you have **all the parts necessary for the installation** of your new Akrapovič product. If any of the parts is missing, please do not proceed with uninstalling your stock parts/installing the Akrapovič product and contact the retailer where you purchased the Akrapovič product.
- Every product or assembly has its unique serial number, which identifies the authenticity of the product. You can find the serial number on the product. Please refer to **picture 1**. Please verify that your product is an original Akrapovič product. If you have any doubts, please contact the reseller where you purchased the product or Akrapovič partners. This manual, any certificates and Akrapovič warranty apply to original products only.

GENERAL NOTE

Photographs and other illustrations in this manual are symbolic and are intended to help represent individual steps for proper installation and use, as well as for a general overview. The actual component parts of the Akrapovič product may not entirely correspond to the photographs and other illustrations.

Picture 1 - SERIAL NUMBER POSITION:

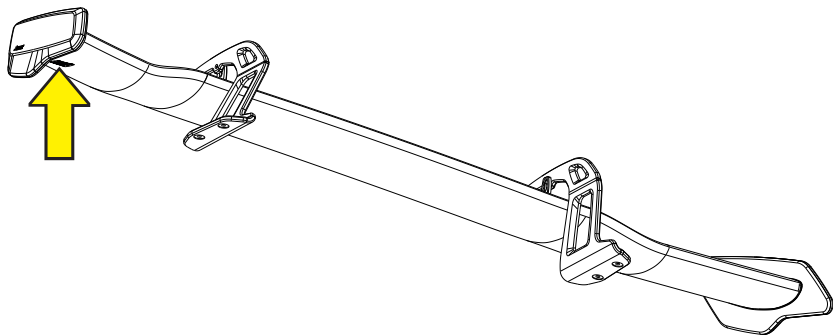

WARNINGS

General warning

Because of the world-wide distribution of Akrapovič d.d. products, neither Akrapovič d.d. nor any of its subsidiaries make any representation that the products comply with the air and/or noise emissions laws, or labeling laws, of any jurisdiction. The purchasers are entirely responsible for informing themselves of the applicable laws where the products are to be used and to comply with those law.

Although legal compliance of Akrapovič products in a specific country should be determined by the user, you can find some basic guidance on compliance of your Akrapovič product with various legal requirements on the product-related part of our website (please use the QR code on the front page or look for the respective product page on www.akrapovic.com). For type approvals, please refer to the certificate enclosed to your product.

This product is ABE Type-Approved (German National Type-Approval). In countries where ABE Type-Approval is not accepted, use of the product may affect your vehicle's certification. Please make sure the product is used in line with all local regulations.

The use of the product may affect your vehicle's warranty or other guarantees or warranties and Akrapovič shall not assume any liability or responsibility in this respect. Please consider any limitations of the warranties or other guarantees accordingly and consult the appropriate documents or contact the seller of the vehicle for more information.

USA WARNING

Various U.S. states and the U.S. federal government have individual laws regulating the use of aftermarket parts and systems, especially as those parts and systems modify, remove, or replace original equipment. Please consult the appropriate laws in your area before installing any aftermarket part or system on your vehicle to ensure compliance with all applicable laws. Neither Akrapovic d.d. nor any of their subsidiaries or the sellers of the parts or systems make any representation that any of their parts or systems comply with any such laws.

SYMBOLS

The following symbols are used throughout these installation instructions:



**TOOLS AND PROTECTIVE
EQUIPMENT REQUIRED**



TIGHTENING TORQUE



LUBRICATION



HAND TIGHTEN



INSTALLATION TIP



CAUTION OR IMPORTANT

USE BOLT SEALANT



Apply 3 to 4 small drops of bolt sealant onto the cleaned and degreased threads before tightening the bolts.

WARNING! Avoid contact with skin, eyes and mucous membranes. Do not inhale fumes. Keep out of reach of children.

USE ANTI-SEIZE LEAD-FREE COPPER PASTE (black tube)



Provides trouble-free and long-lasting protection against seizing, corrosion and rusting of bolts, threaded ends, nuts, joints, etc. Also protects against vibration, wear and impact. **WARNING! Avoid eye contact. Keep out of reach of children.**

USE ANTI-SEIZING GREASE (white tube)



Prevents seizing, corrosion and excessive wear between the titanium components. **WARNING! Avoid eye contact. Keep out of reach of children.**

Tools & equipment

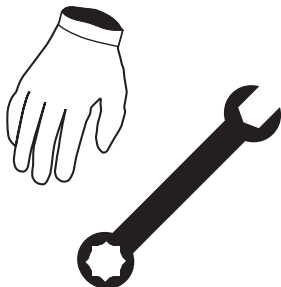

- Mechanic gloves
- Eye protection
- Power Drill
- Rubber Adhesive Eraser Wheel
- Automatic Adjustable Centre Punch
- Industrial Vacuum Cleaner
- Torx 30
- Flat screwdriver
- 16,5mm/90° Counter Sink Drill Bit
- Pneumatic Grinder With Conical Burr
- 30mm Hole Saw
- Rivet Nut Setting Tool (M5)
- Drill Bits: 2mm, 6mm, 7mm, 11,5mm

PARTS LIST

The packaging box should contain one or more of the following items:

- Akrapovič product
- Homologation certificate/ compliance documents if applicable
- Warranty
- Fitting material
- Installation Manual

Detailed list of parts can be found on the Akrapovič website (please use the QR code on the front page or look for “Schematic view” in the respective product page on www.akrapovic.com).

IMPORTANT: the vehicle should be turned off (in the off position) throughout the dismantling and installation process, as well as any other work done on, or with respect to the Akrapovič product!

REMOVAL OF VEHICLE'S STOCK PARTS:

The process of uninstalling the original or other parts may vary depending on the existing vehicle parts. Please follow the original vehicle or part manufacturer's workshop manual for uninstalling the original parts.

If you for any reason decide otherwise, please note that any information provided in this respect herein should be considered as general information provided for your convenience only. Akrapovič shall not assume any liability or responsibility with regard to uninstalling your existing parts, warranty coverage of such parts, vehicle or their further fitness for use.

In case the Akrapovič products may not be used on certain roads or under certain conditions, please keep the stock (or other) parts that you can use in such circumstances legally.

INSTALLATION OF AKRAPOVIČ PRODUCT:

It is necessary that installation of Akrapovič products is done professionally by well equipped automotive workshop. If you for any reason decide otherwise, please note, that this could have impact on the vehicle and part performance or warranty in the event that the vehicle or part is damaged due to unprofessional installation. At the same time, unprofessional installation of Akrapovič product, may cause damage to others and the product may not fulfill its purpose.

Akrapovič shall not assume any liability or responsibility with regard to the installation of the product.

INSTALLATION OF THE AKRAPOVIČ REAR WING:

1. Carefully remove the stock rear spoiler off the boot lid and remove all adhesive residue, using rubber adhesive eraser wheel; check vehicle manufacturer workshop manual for details (**F 01**).

! **CAUTION:** make sure not to injure yourself or damage any part of the vehicle during this process!



F 01

2. Open the boot lid and remove the boot lid trim, as shown; check vehicle manufacturer workshop manual for details (F 02, 03, 04, 05).

! CAUTION: make sure not to injure yourself or damage any part of the vehicle during this process!



F 02



F 03

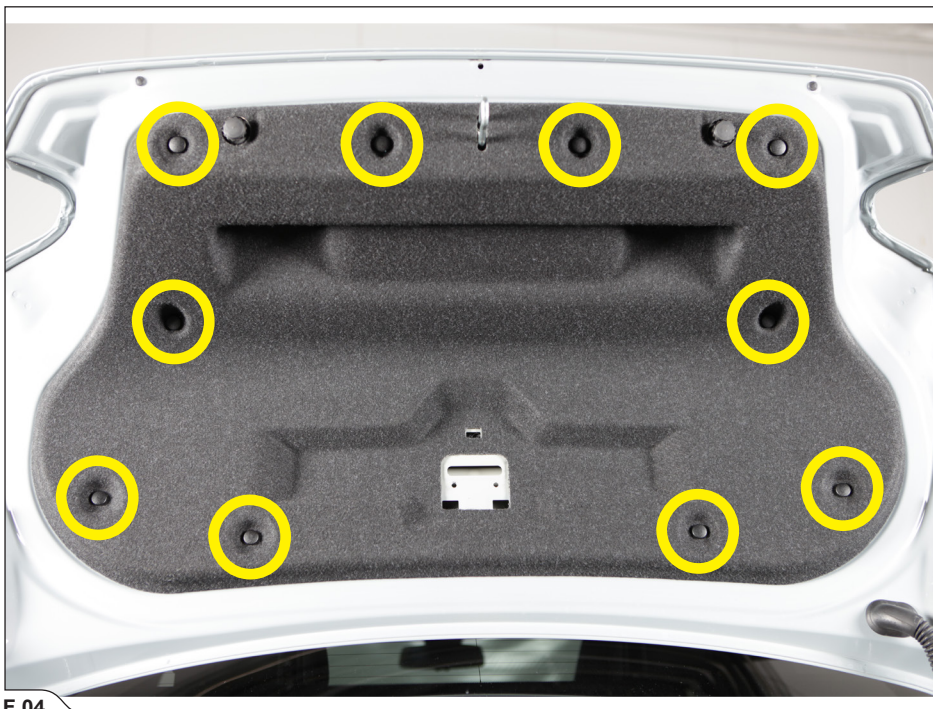

F 04



F 05

3. Place the drill template (Akrapovič installation kit) flush onto the boot lid, precisely align it with the lid edges as shown and secure the template with masking tape (F 06, 07).

! **CAUTION:** make sure not to injure yourself or damage any part of the vehicle during this process!

! **IMPORTANT:** be very precise with placing and aligning of the template!

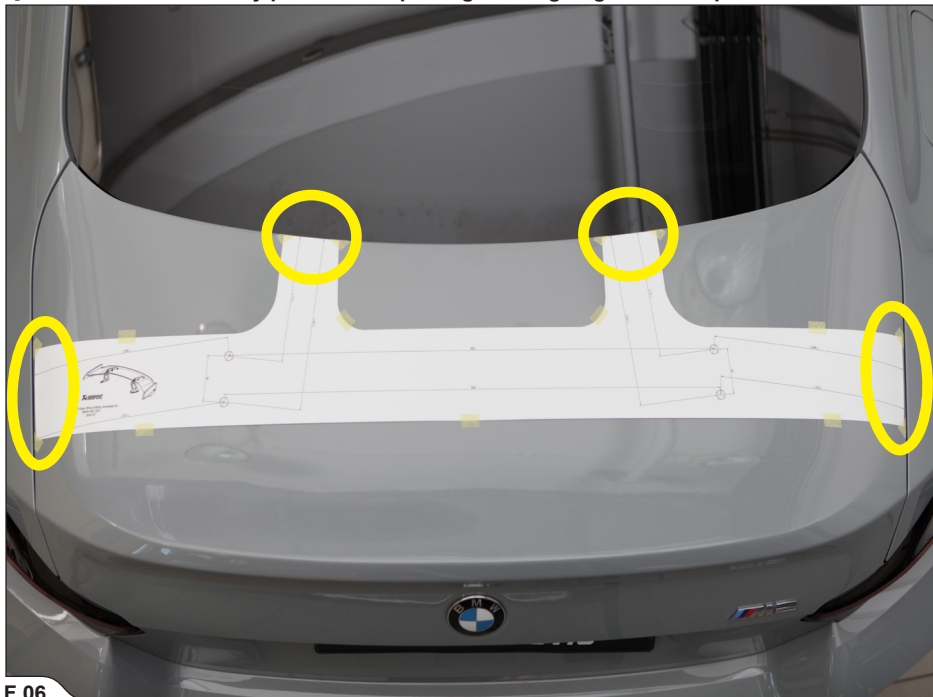

F 06

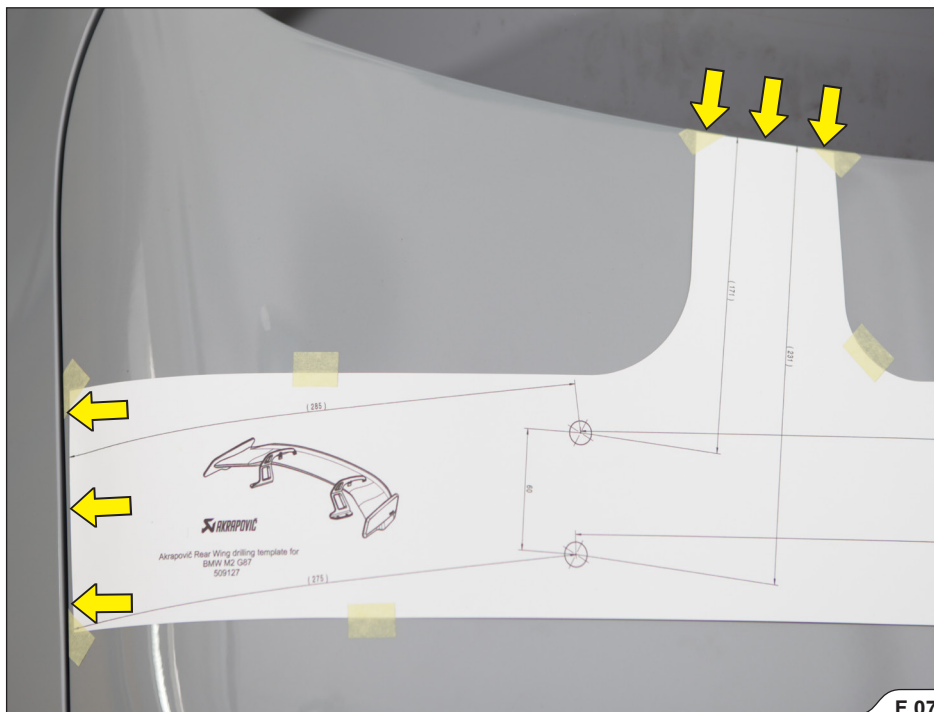

- Precisely transfer all four marks onto the lid's surface, using center punch; remove the drill template when done (F 08, 09).

! CAUTION: make sure not to injure yourself or damage any part of the vehicle during this process!

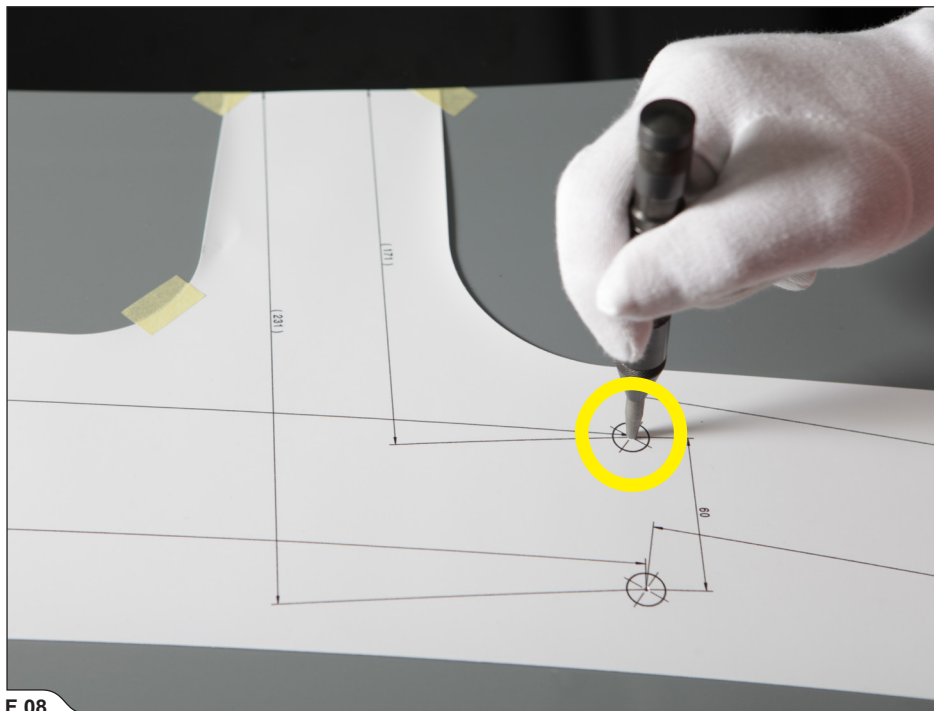

F 08

4x

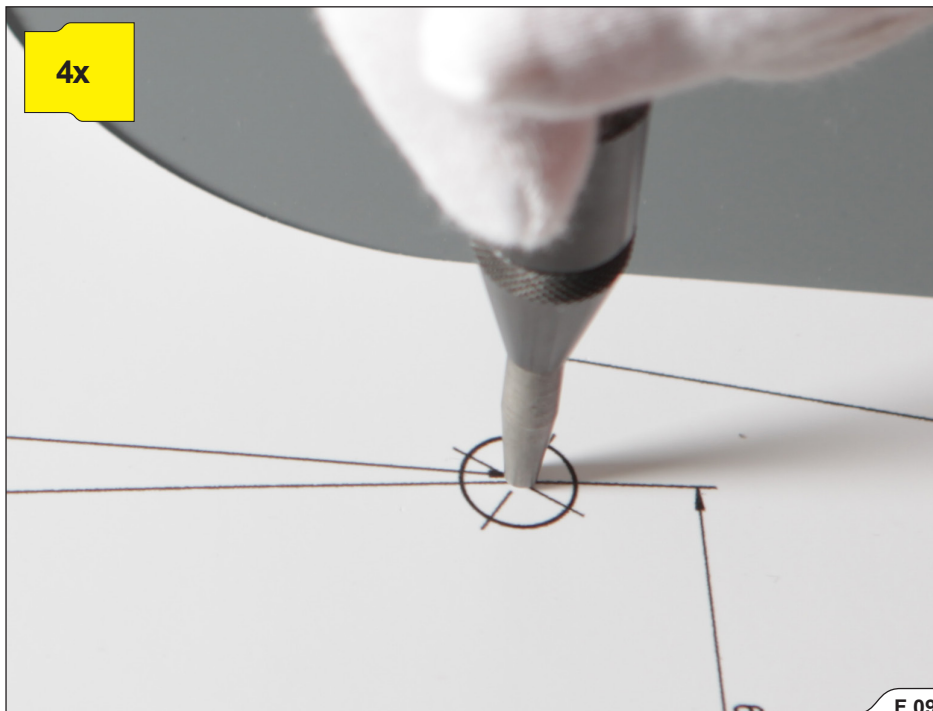

F 09

5. Protect the surface of the boot lid, using protective foil or equivalent (F 10, 11).

! **CAUTION:** make sure not to injure yourself or damage any part of the vehicle during this process!



F 10



F 11

6. Protect the complete rear end of the car (rear windscreen, rear wheel arch panels, rear bumper and boot opening) in such a way, the boot lid can be opened and closed, using protective cloth or equivalent (F 12, 13).

! CAUTION: make sure not to injure yourself or damage any part of the vehicle during this process!



F 12



F 13

7. Carefully drill all four boot lid's marks, using 2 mm drill bit; make sure you drill through outer and inner shell of the boot lid (F 14).

! **IMPORTANT:** make sure you hold the power drill perpendicular to the lid's surface during drilling! Drill the holes at high power drill speed and with sharp drill bit!

! **IMPORTANT:** use the industrial vacuum cleaner during drilling, to extract drilling chips!

! **CAUTION:** make sure not to injure yourself or damage any part of the vehicle during this process!

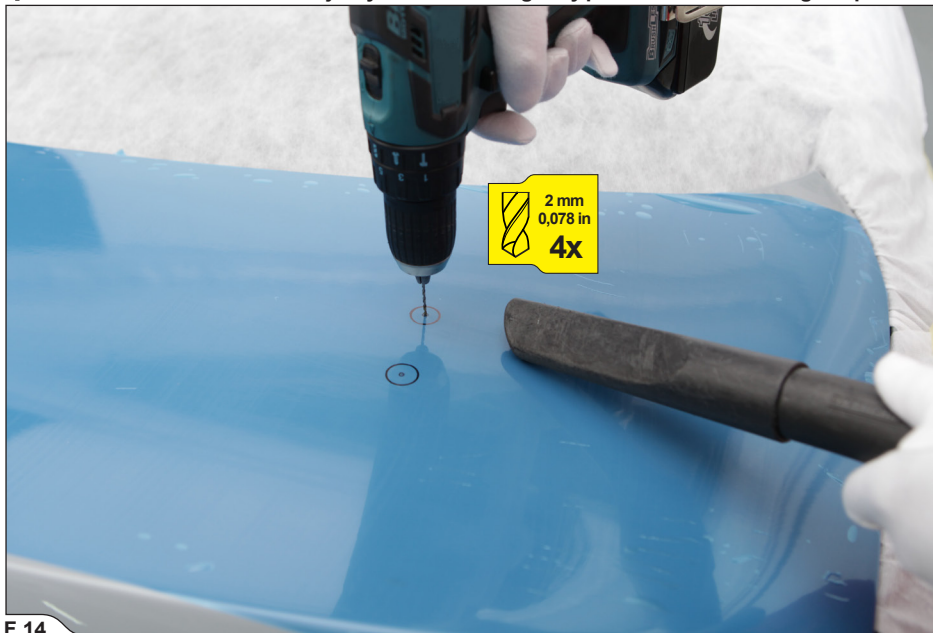

F 14

8. Carefully re-drill all four boot lid's holes, using **6 mm** drill bit; **make sure you drill through outer and inner shell of the boot lid (F 15).**

! **IMPORTANT:** make sure you hold the power drill perpendicular to the lid's surface during drilling! Drill the holes at high power drill speed and with sharp drill bit!

! **IMPORTANT:** use the industrial vacuum cleaner during drilling, to extract drilling chips!

! **CAUTION:** make sure not to injure yourself or damage any part of the vehicle during this process!

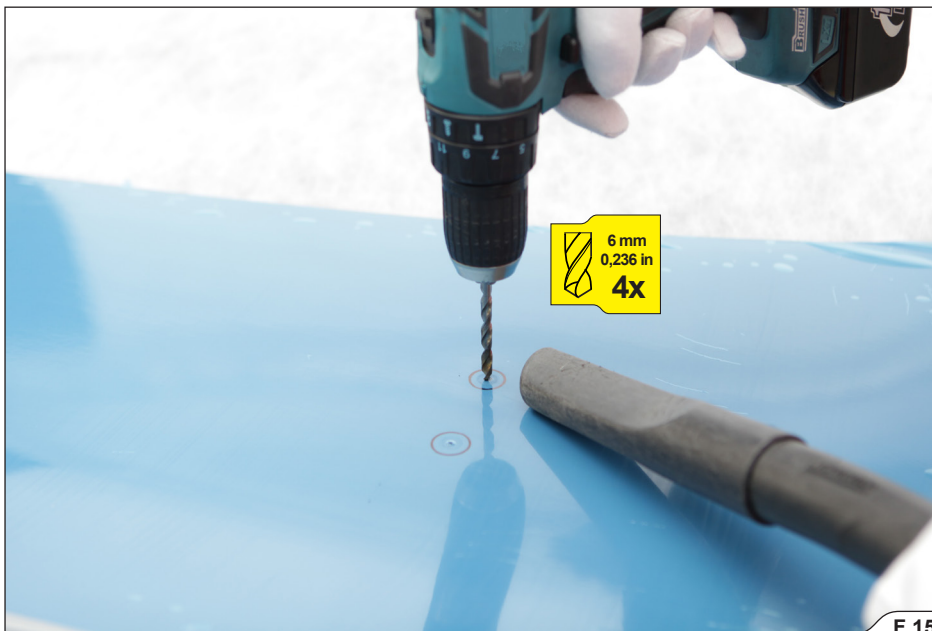

F 15

9. Open the boot lid and carefully expand all four **inner** holes as shown, using **30 mm** hole saw; **make sure you saw through inner shell of the boot lid only (F 16).**

! **IMPORTANT:** make sure you saw through inner shell of the boot lid only! Saw the holes at high power drill speed and with sharp hole saw!

! **IMPORTANT:** use the industrial vacuum cleaner during drilling, to extract drilling chips!

! **CAUTION:** make sure not to injure yourself or damage any part of the vehicle during this process!



F 16

10. Carefully remove the marked adhesive on both sides of the lid (F 17).

! CAUTION: make sure not to injure yourself or damage any part of the vehicle during this process!

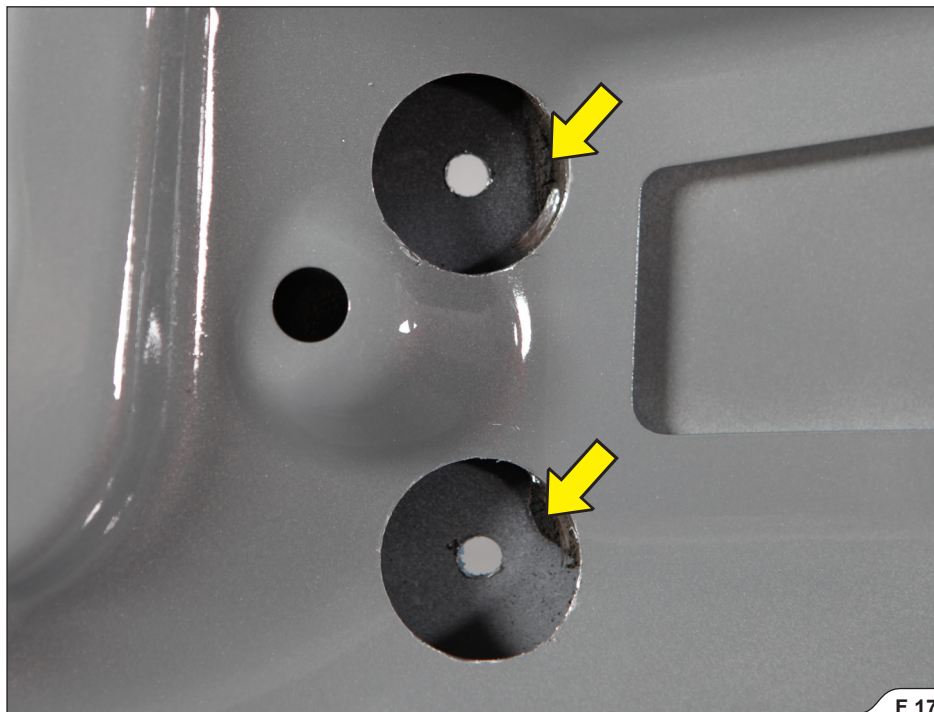

F 17

11. Carefully re-drill all four outer shell boot lid's holes, using **11,5 mm** drill bit (**F 18**).

! **IMPORTANT:** make sure you hold the power drill perpendicular to the lid's surface during drilling! Drill the holes at high power drill speed and with sharp drill bit!

! **IMPORTANT:** use the industrial vacuum cleaner during drilling, to extract drilling chips!

! **CAUTION:** make sure not to injure yourself or damage any part of the vehicle during this process!



F 18

12. Countersink all drilled holes, using countersink bit and conical burr (F 19, 20, 21).

! **CAUTION:** make sure not to injure yourself or damage any part of the vehicle during this process!

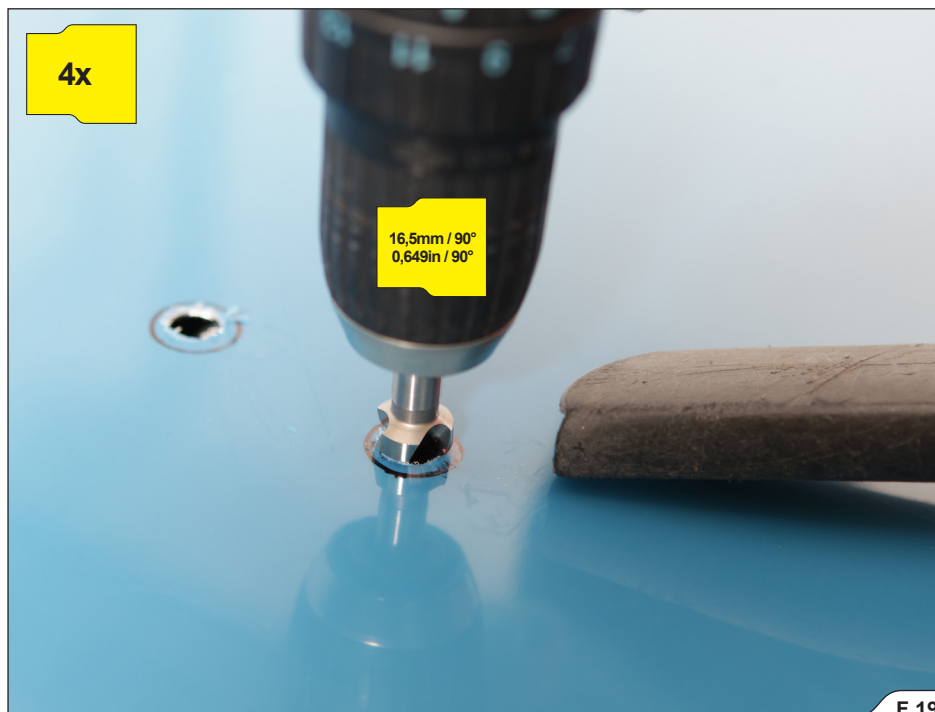

4x

16,5mm / 90°
0,649in / 90°

F 20

4x



F 21

13. Protect the exposed metal in all drilled holes, using anti-corrosion treatment (F 22, 23).

! **CAUTION:** make sure not to injure yourself or damage any part of the vehicle during this process!

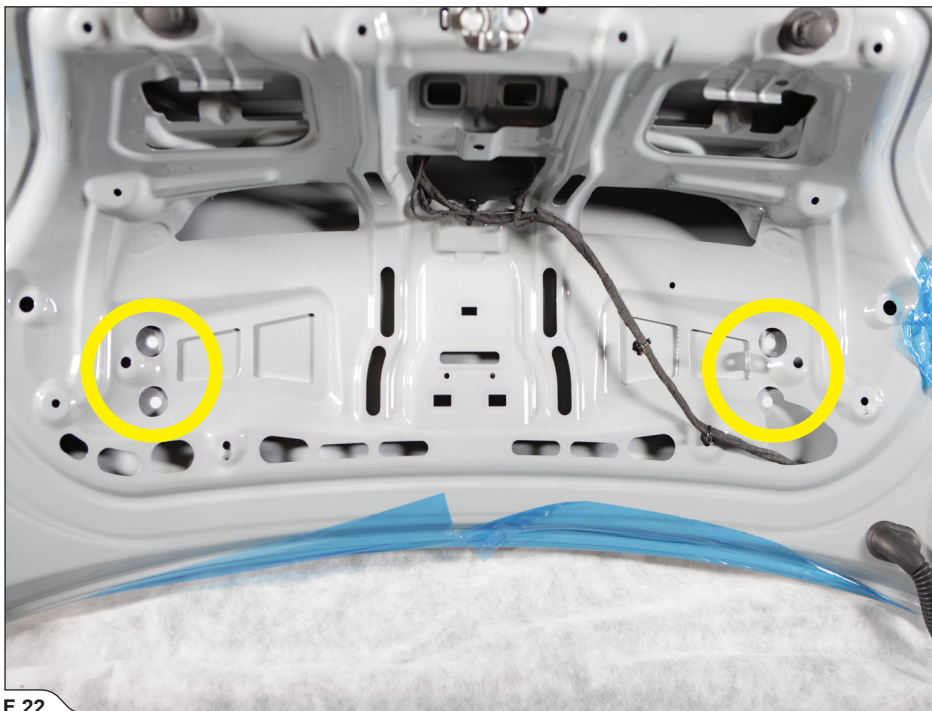

F 22

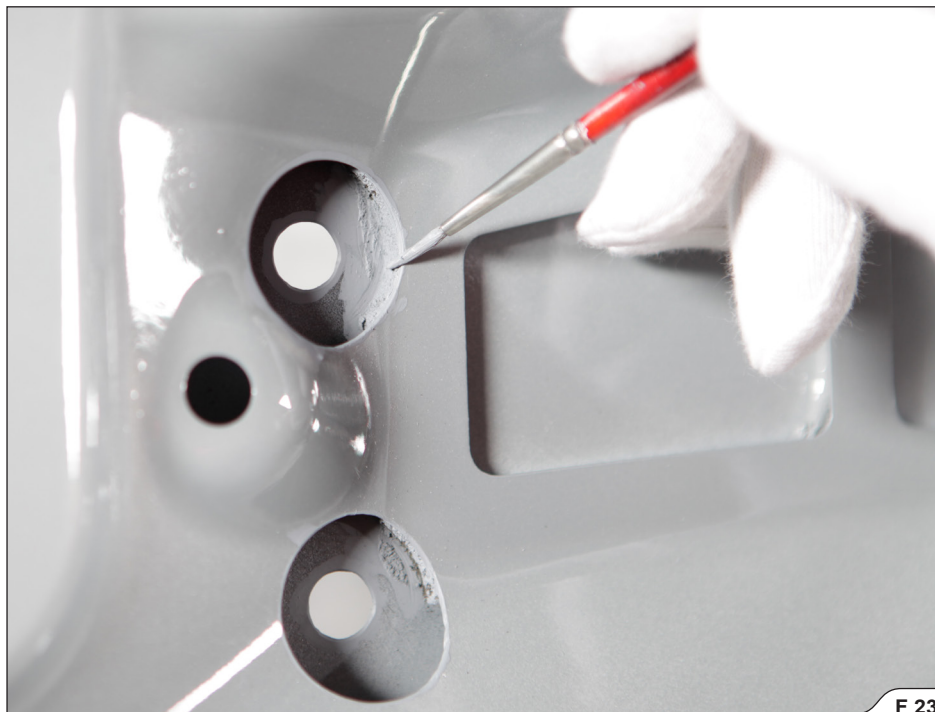

14. Assemble the left and right rear wing reinforcement plates with adjustable bushings (Akrapovič installation kit), as shown (F 24, 25).

! CAUTION: make sure not to injure yourself or damage any part of the vehicle during this process!



F 24

2x



F 25

15. Install and carefully align reinforcement plates against the boot lid, adjust the bushings in such a way, they touch the outer shell of the lid and make sure they are secured in the centers of the holes (F 26, 27, 28).

! CAUTION: make sure not to injure yourself or damage any part of the vehicle during this process!

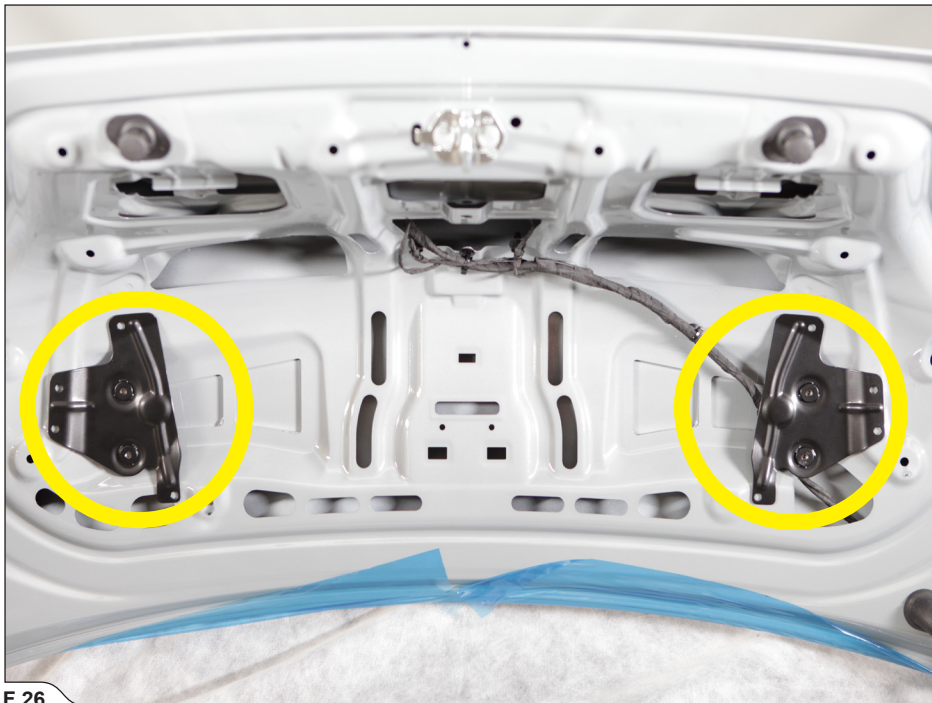

F 26



4x

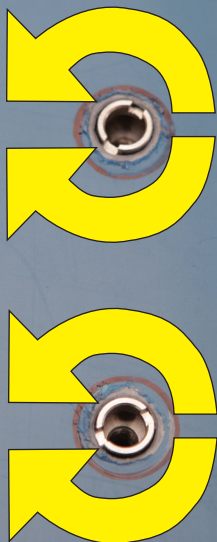

F 28

16. Precisely transfer all reinforcement plates' holes onto the inner shell lid's surface, using center punch (F 29, 30).

! CAUTION: make sure not to injure yourself or damage any part of the vehicle during this process!

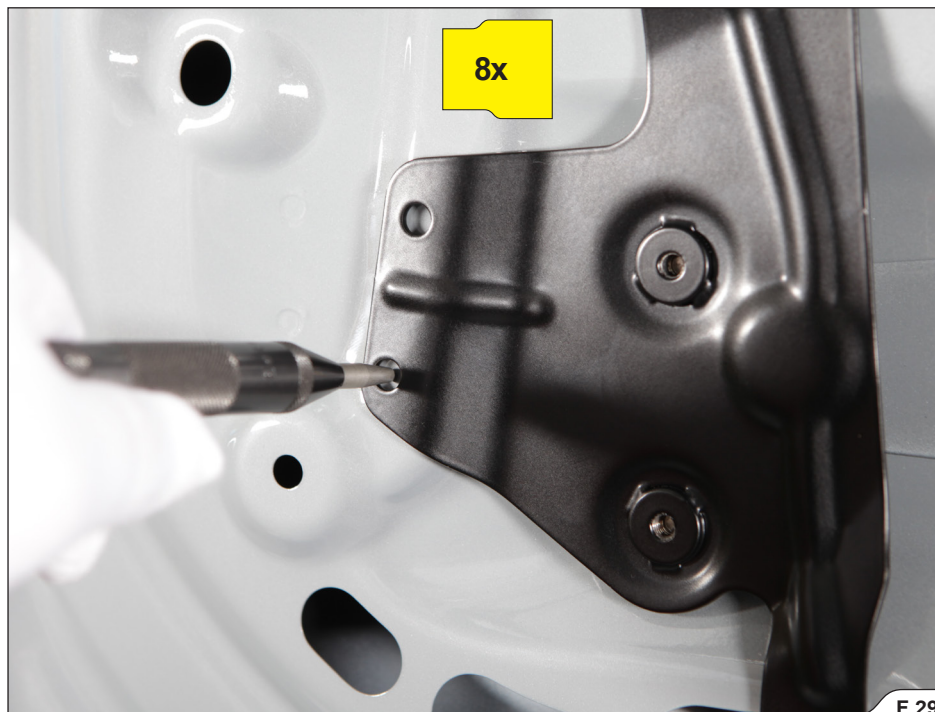

F 29

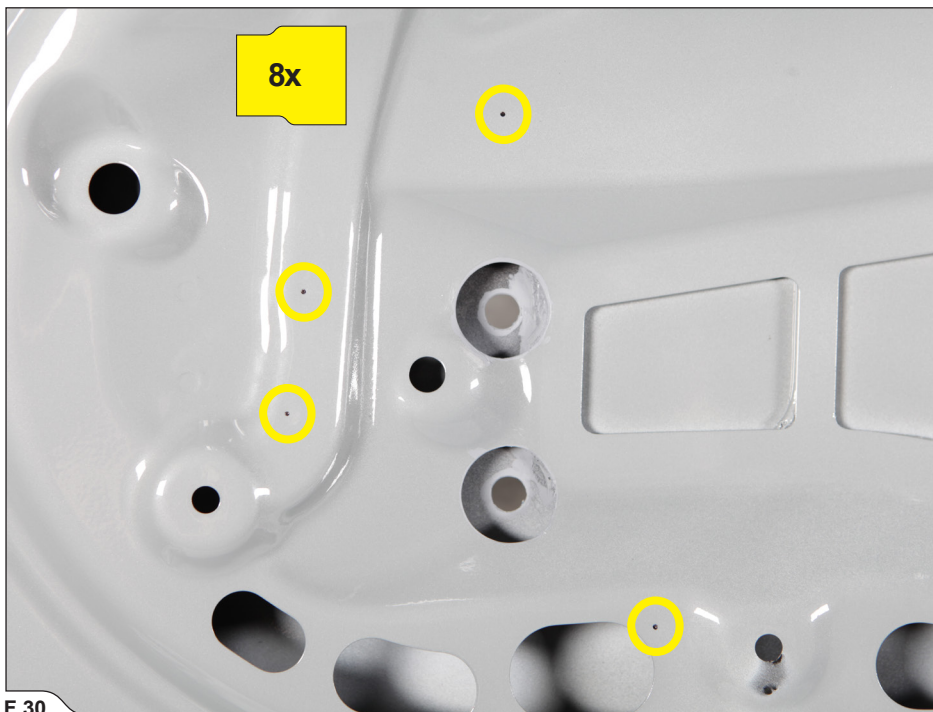

F 30

17. Carefully drill all marked positions, using **2 mm** drill bit; **make sure you drill through INNER SHELL of the boot lid ONLY(F 31).**

! **IMPORTANT:** make sure you hold the power drill perpendicular to the lid's surface during drilling! Drill the holes at high power drill speed and with sharp drill bit!

! **IMPORTANT:** use the industrial vacuum cleaner during drilling, to extract drilling chips!

! **CAUTION:** make sure not to injure yourself or damage any part of the vehicle during this process!



F 31

18. Carefully re-drill all reinforcement plates' holes, using 7 mm drill bit; **make sure you drill through INNER SHELL of the boot lid ONLY (F 32).**

! **IMPORTANT:** make sure you hold the power drill perpendicular to the lid's surface during drilling! Drill the holes at high power drill speed and with sharp drill bit!

! **IMPORTANT:** use the industrial vacuum cleaner during drilling, to extract drilling chips!

! **CAUTION:** make sure not to injure yourself or damage any part of the vehicle during this process!



F 32

19. Countersink all drilled holes, using countersink bit; countersink the holes just enough, so the rivet nuts seat flush with the surface - **do not over countersink the holes!** (F 33, 34).

! CAUTION: make sure not to injure yourself or damage any part of the vehicle during this process!



F 33

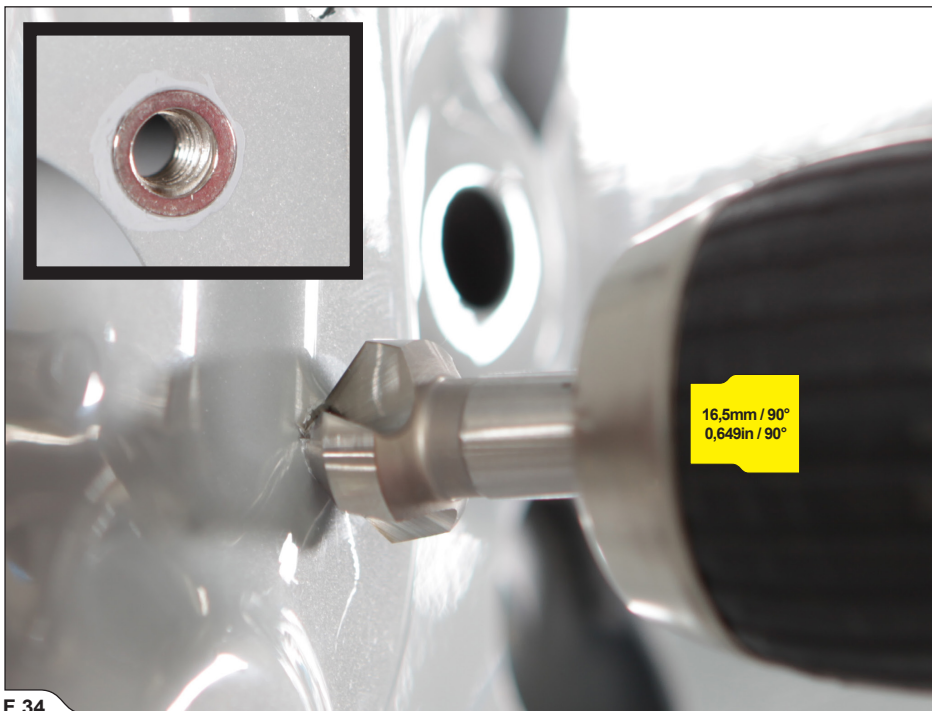

F 34

20. Protect the exposed metal in all drilled holes, using anti-corrosion treatment (F 35).

! **CAUTION:** make sure not to injure yourself or damage any part of the vehicle during this process!



F 35

21. Install all eight rivet nuts (Akrapovič installation kit), using rivet nut setting tool (F 36).

! **CAUTION:** make sure not to injure yourself or damage any part of the vehicle during this process!

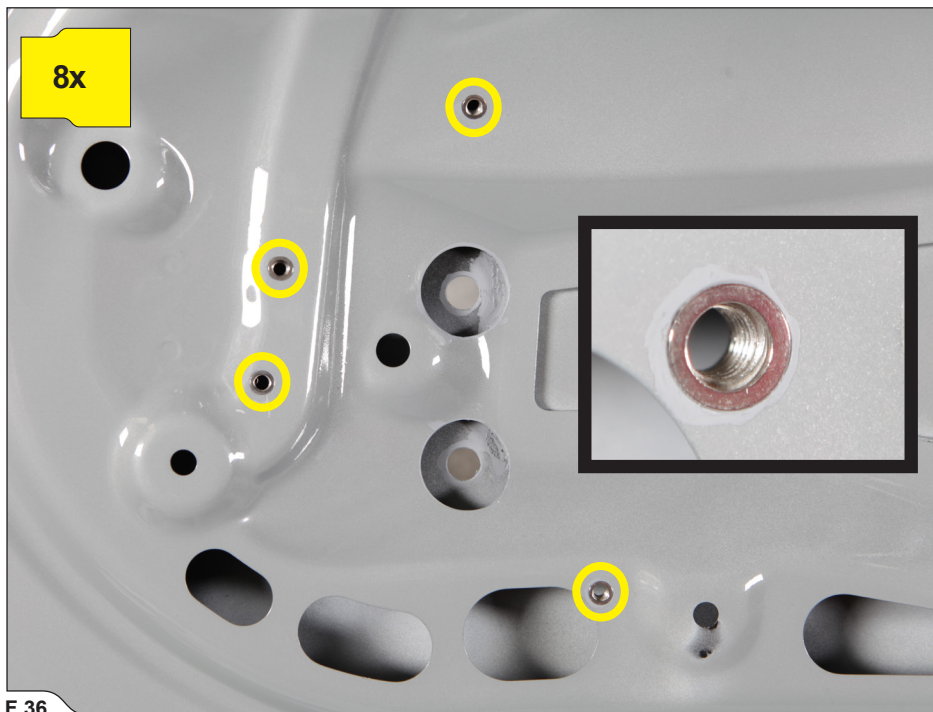

F 36

22. Remove the protective foil off the boot lid and all the rest protection off the vehicle. Install the four sealing washers from Akrapovič installation kit, onto the adjustable bushings, as shown (F 37).

! **CAUTION:** make sure not to injure yourself or damage any part of the vehicle during this process!



23. Install and align reinforcement plates against the boot lid, hand tighten them onto the lid, using M5x16 bolts from Akrapovič installation kit and adjust the bushings in such a way, they touch the outer shell of the lid - **make sure they are secured in the centers of the holes (F 38, 39, 40).**

! CAUTION: make sure not to injure yourself or damage any part of the vehicle during this process!

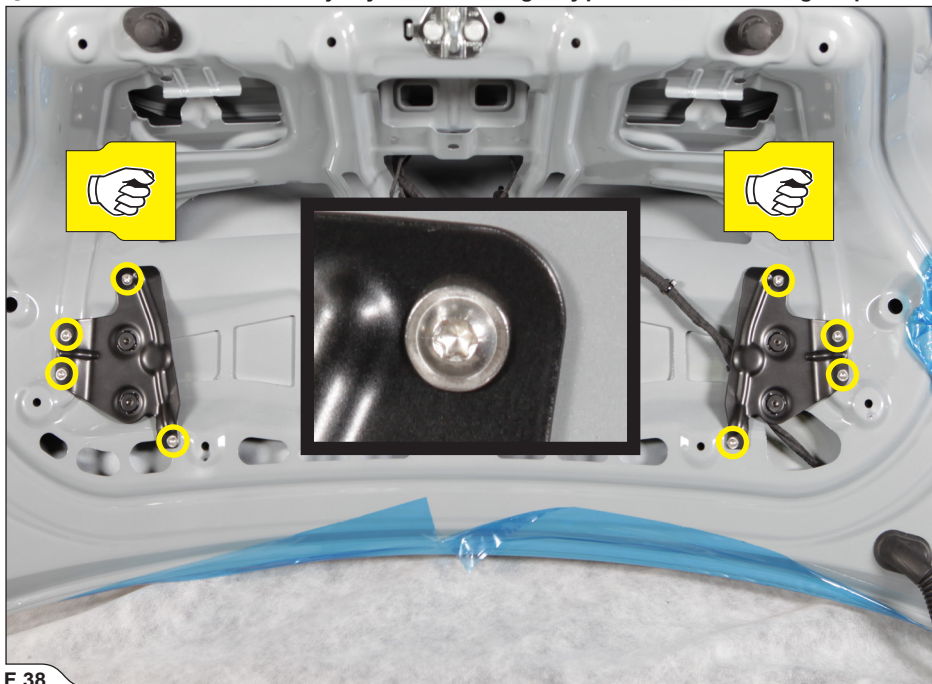

F 38

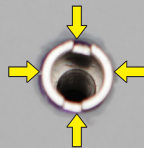
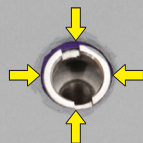

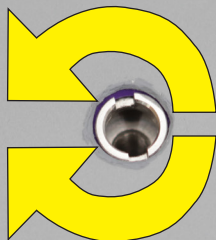

F 40

24. Tighten all reinforcement plates' bolts to the specified torque (F 41, 42).

! **CAUTION:** make sure not to injure yourself or damage any part of the vehicle during this process!

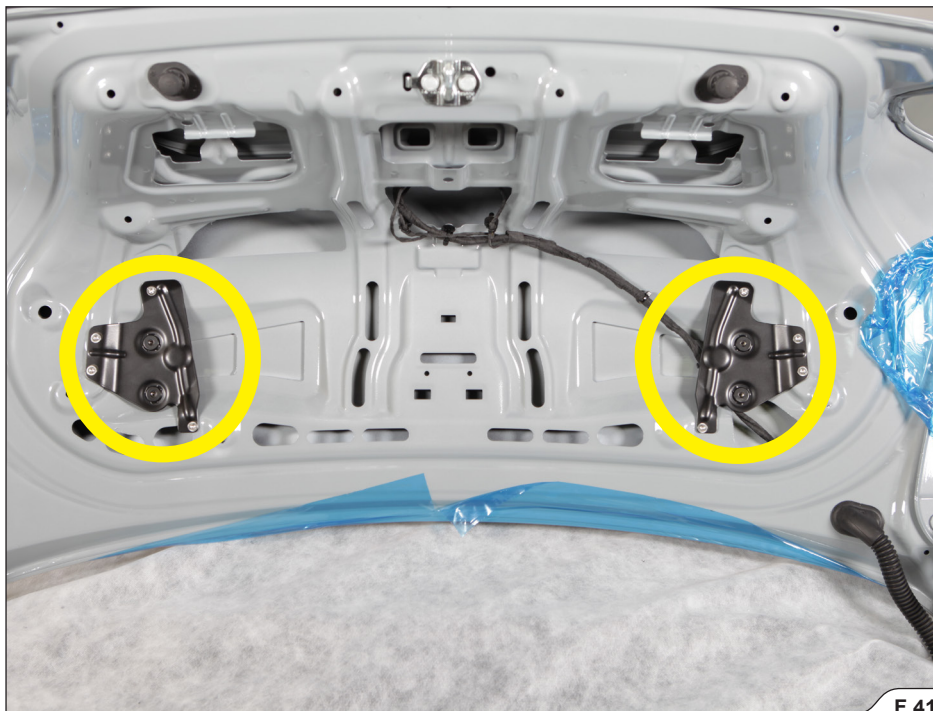

F 41



F 42

25. Precisely stick the pre-cut transparent protective foil from Akrapovič installation kit, onto the boot lid's outer shell, as shown (F 43, 44).

! **IMPORTANT:** there are LEFT and RIGHT protective foils! Make sure you stick them correctly!

! **CAUTION:** make sure not to injure yourself or damage any part of the vehicle during this process!



F 43

2x

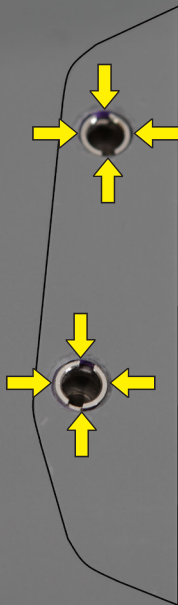

F 44

26. Precisely stick the pre-cut protective washers from Akrapovič installation kit, onto both brackets, as shown (F 45).

! CAUTION: make sure not to injure yourself or damage the brackets during this process!

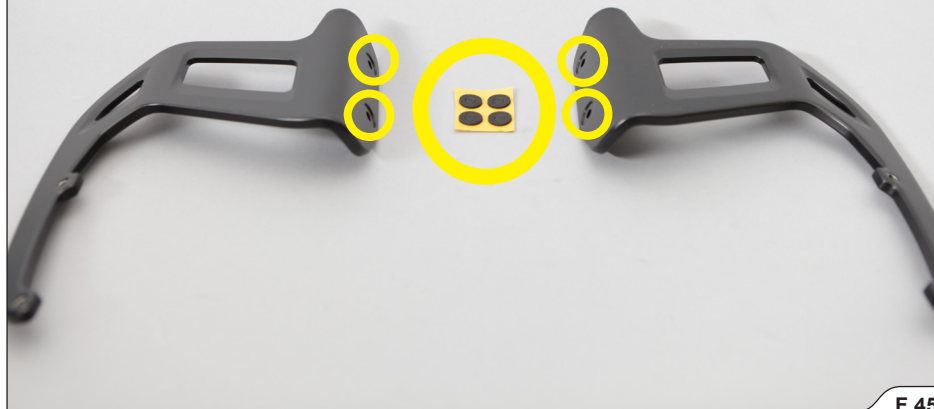
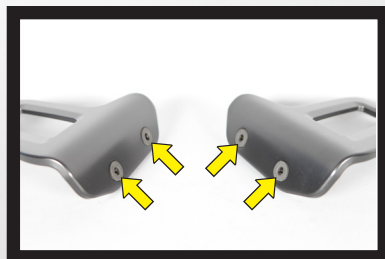

F 45

27. Akrapovič brackets' installation material (F 46):

- 1 - Tamper-proof driver
- 2 - Tamper-proof M6x25 bolt
- 3 - Torx M6x25 bolts
- 4 - O-Ring bolt seals



F 46

28. Install O-Ring seals (Akrapovič installation kit) on all brackets' bolts (F 47).

! CAUTION: make sure not to injure yourself or damage the O-Rings during this process!



29. Install both brackets onto the boot lid, as shown and tighten bolts to the specified torques (F 48, 49, 50).

! **IMPORTANT:** make sure that the Tamper-Proof bolt is installed at the marked position (F50)!

! **IMPORTANT:** after tightening of the bolts, check if both brackets seat flush against the boot lid surface; re-adjust the reinforcement plates' adjustable bushings if necessary!

! **CAUTION:** make sure not to injure yourself or damage any part of the vehicle during this process!



F 48



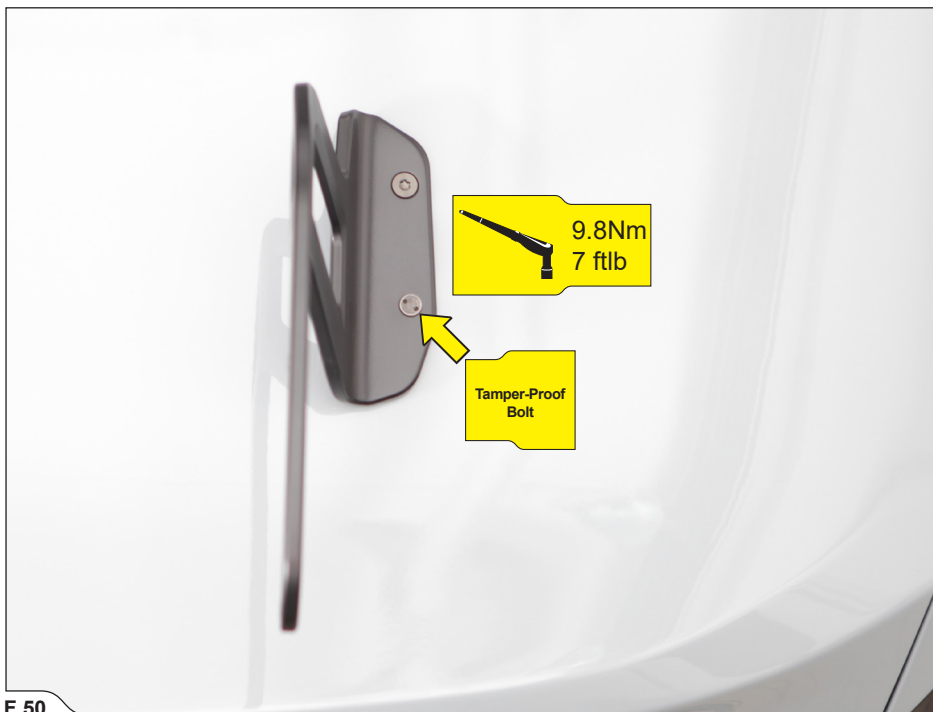

F 50

30. Install and hand tighten the Rear Wing onto the brackets, using M6x12 bolts from Akrapovič installation kit; install the front bolts at chosen position: **LOW**, **MIDDLE** or **HIGH** downforce (F 51, 52, 53, 54, 55, 56).

! **CAUTION:** make sure not to injure yourself or damage any part of the vehicle during this process!

! **IMPORTANT:** choose the front bolts' position in respect to the Downforce and Drag graphs and according to your personal preference (F 55, 56).



F 51

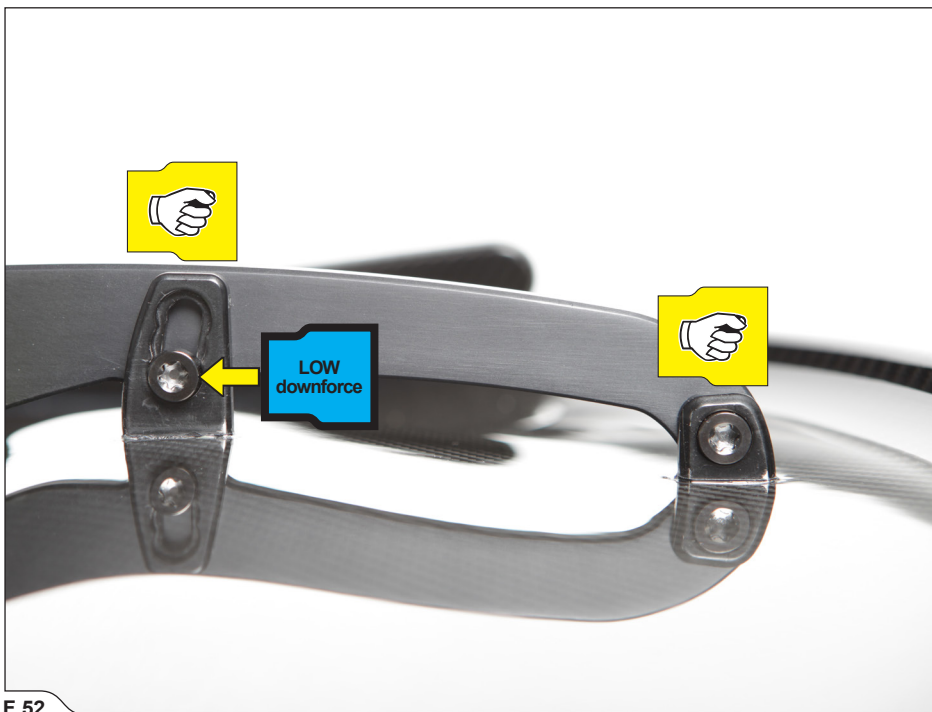

F 52

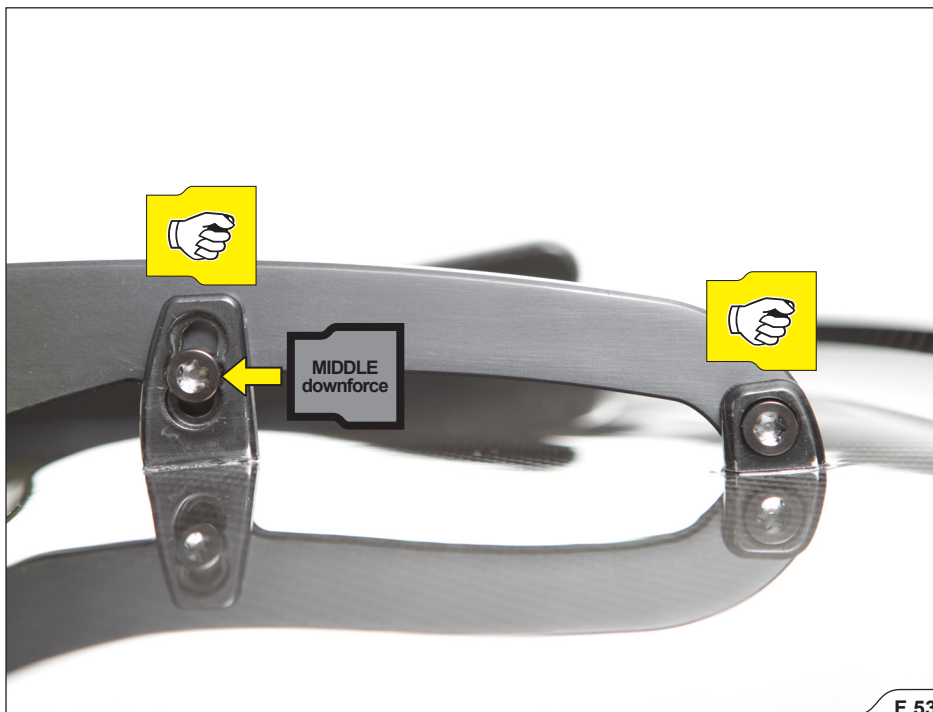

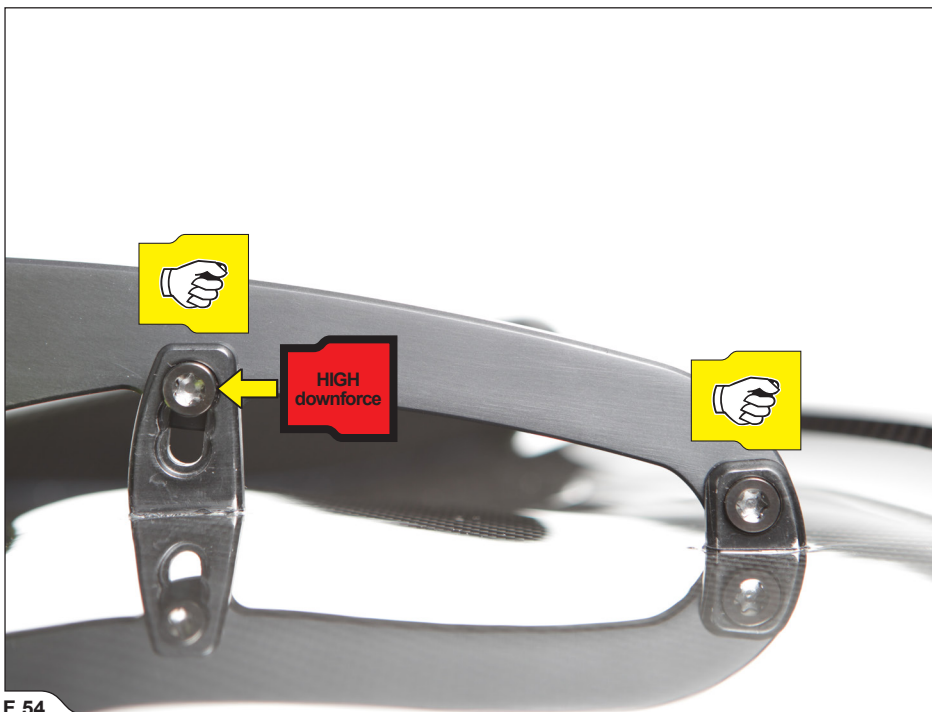

F 54

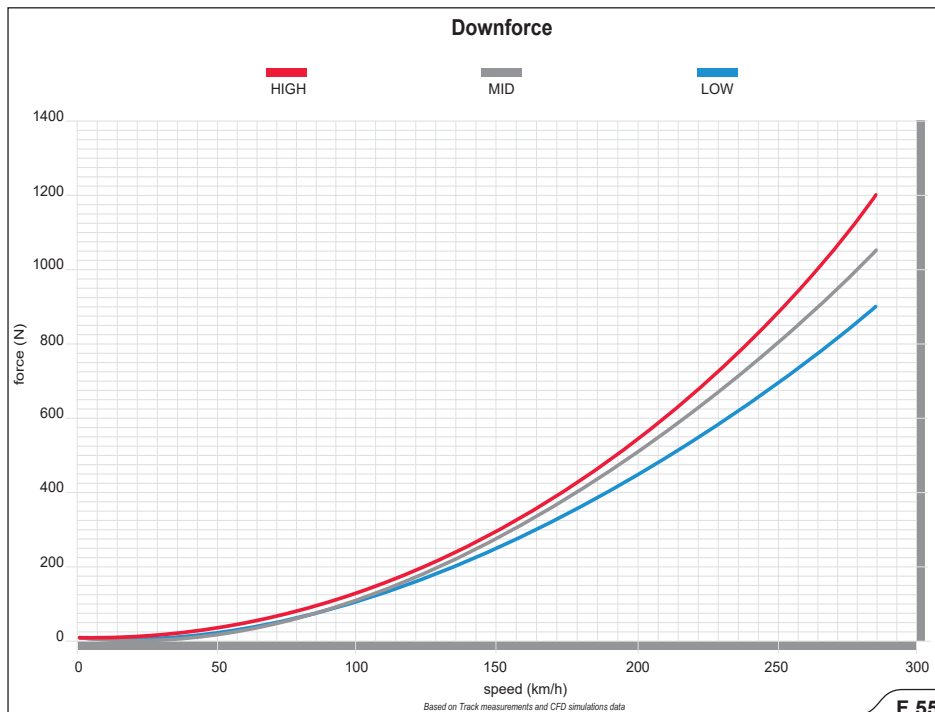

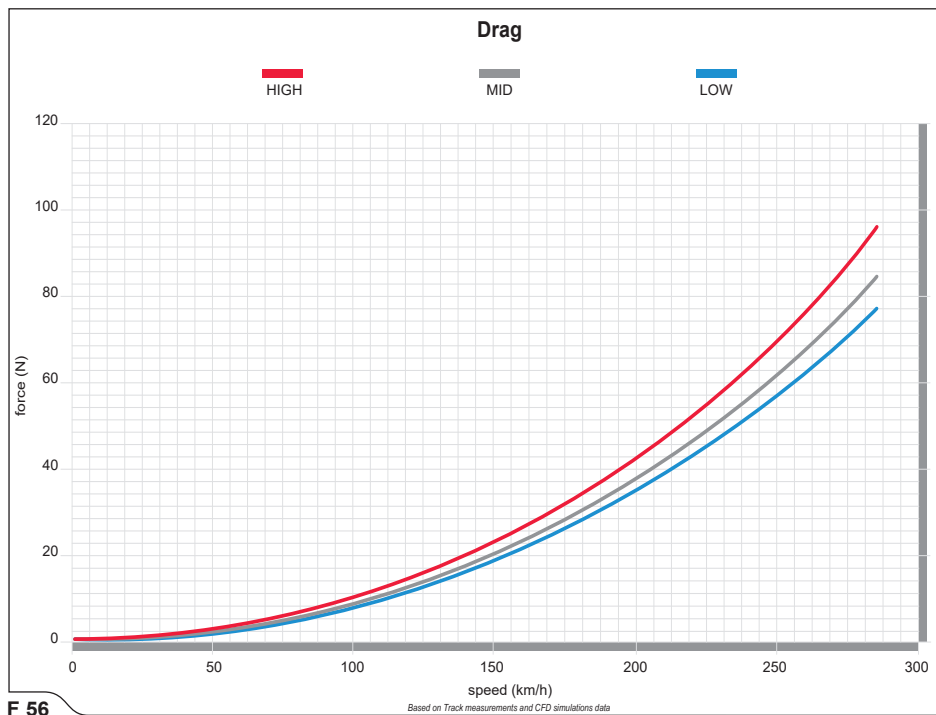

F 56

31. Tighten all four Rear Wing bolts to the specified torque (**F 57**).

! CAUTION: make sure not to injure yourself or damage any part of the vehicle during this process!

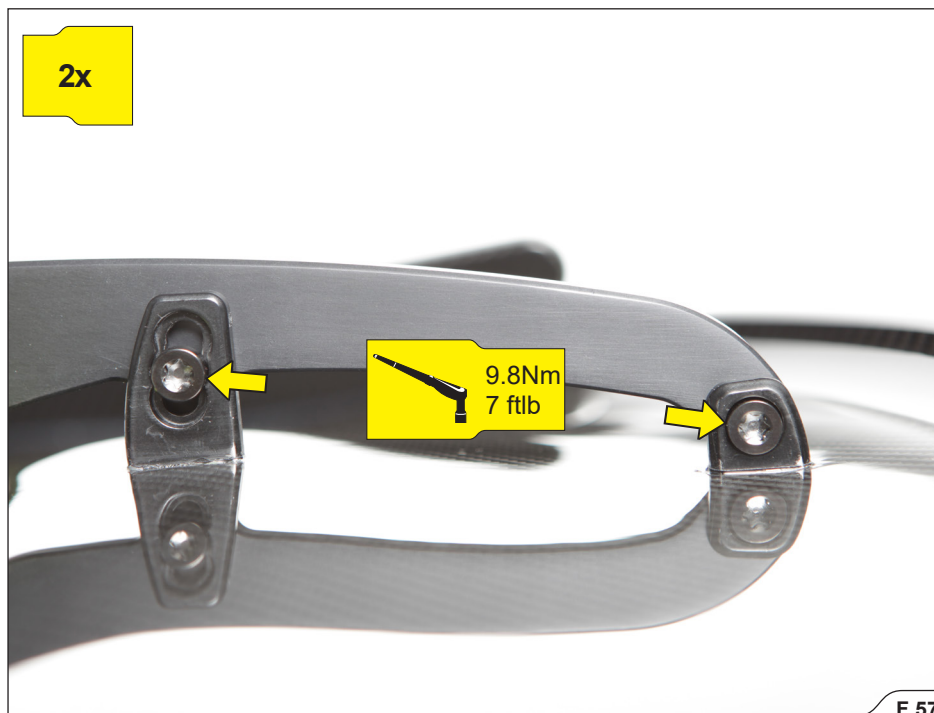

31. Reinstall the boot lid trim in the reverse order; check vehicle manufacturer workshop manual for correct procedures (F 58).

! CAUTION: make sure not to injure yourself or damage any part of the exhaust system during this process!



F 58

FINAL INSTALLATION:

- ! **IMPORTANT:** reinstall the dismantled or partially removed stock parts; check vehicle manufacturer workshop manual for correct procedures and tightening torques.
- ! **IMPORTANT:** make sure all the nuts and bolts are sufficiently tightened. In case the Akrapovič product touches the cowling or other parts, repeat the adjustment of the product or contact your authorized dealer.
- ! **IMPORTANT:** clean all Akrapovič product's surfaces before the first start of the engine or the stains will burn onto the surfaces!

MAINTENANCE OF THE AKRAPOVIČ PRODUCT:

1. Clean all Akrapovič product's surfaces. Cleaning will prevent spots from burning onto the surface. Do not use aggressive chemical cleaners, because they can damage the surface:
 - **Titanium surfaces** (titanium muffler's outer sleeve, titanium pipes etc): use a soft cloth sprayed with a multi-purpose spray lubricant (WD-40® or equivalent)*, then wipe with a soft dry cloth.
 - **Carbon-fiber surfaces** (carbon-fiber outlet cap, carbon-fiber muffler's outer sleeve, carbon-fiber bracket etc): use a soft dry cloth sprayed with all purpose foam cleaner, then wipe with a soft dry cloth.
 - **Painted surfaces** (painted outlet cap, painted muffler's outer sleeve, painted bracket etc): use a soft cloth sprayed with all purpose foam cleaner, then wipe with a soft dry cloth.
 - **Chrome plated surfaces** (chrome plated outlet cap, chrome plated muffler's outer sleeve etc): use a soft cloth sprayed with all purpose foam cleaner, then wipe with a soft dry cloth.
 - **Stainless steel surfaces** (stainless steel muffler's outer sleeve, stainless steel pipes etc): use a soft cloth sprayed with a contact cleaner, then wipe with a soft dry cloth.

*WD-40® is a trademark of the WD-40 Company.
2. Periodically check if all the Akrapovič product's nuts and bolts are sufficiently tightened.

- ! **IMPORTANT: DO NOT USE AUTOMOTIVE WHEEL CLEANERS OR ANY CLEANING PRODUCTS WHICH CONTAIN ACIDIC ADDITIVES TO CLEAN THE AKRAPOVIČ PRODUCT.**
- ! **IMPORTANT: WE RECOMMEND HIGH CAUTION WHEN USING POWER / PRESSURE WASHER FOR CLEANING PAINTED / LACQUERED SURFACES OF THE AKRAPOVIČ COMPONENTS, TO AVOID PAINT / LACQUER DAMAGE.**
- ! **IMPORTANT: SOME OF THE AKRAPOVIČ CARBON FIBER COMPONENTS ARE ADDITIONALLY PROTECTED AGAINST ROCK CHIPS WITH CLEAR LACQUER OR PROTECTION FILM. IN SUCH CASE THE PROTECTION FILM IS AVAILABLE AS SPARE PART BY AKRAPOVIČ COMPANY. THE PROTECTION FILM IS NOT THE SUBJECT OF THE AKRAPOVIČ WARRANTY.**
- ! **IMPORTANT: ALL AKRAPOVIČ PRODUCTS ARE DEVELOPED AND DESIGNED TO BE USED ON SPECIFIC VEHICLES, FOR THEIR ENTIRE EXPECTED LIFETIME. PLEASE MAKE SURE THAT END-OF-LIFE AKRAPOVIČ PRODUCT IS DISASSEMBLED TO COMPONENTS SHOWN IN THE PRODUCT'S SCHEMATIC DIAGRAM AVAILABLE ON THE AKRAPOVIČ WEBSITE AND EACH COMPONENT SCRAPPED RESPONSIBLY AND ACCORDING TO APPLICABLE LOCAL LAWS AND REGULATIONS. AKRAPOVIČ DOES NOT ASSUME ANY OBLIGATION OR RESPONSIBILITY WITH RESPECT TO THE SCRAPPING PROCESS OR PROVIDING INFORMATION RELATED THERETO.**
- ! **CAUTION: THIS MANUAL IS SPECIFIC TO THE BMW M2 TYPE G87. THERE MAY BE SOME DIFFERENCES IN INSTALLATION PROCEDURES FOR OTHER MODELS.**

www.akrapovic.com

