



Installation instructions

Akrapovič Exhaust System:

Slip-On

for the

BMW M135i (type F40)

BMW X2 M35i (type F39)

MINI JCW Clubman ALL4 (type F54)

MINI JCW Countryman ALL4 (type F60)

ENGLISH

Version 1.0

11/2020



www.akrapovic.com

D249.1.00.0000 A



Installation instructions

Akrapovič Exhaust System:

Slip-On

for the

BMW M135i (type F40)

BMW X2 M35i (type F39)

MINI JCW Clubman ALL4 (type F54)

MINI JCW Countryman ALL4 (type F60)

ENGLISH

Version 1.0

11/2020

www.akrapovic.com

D249.1.00.0000 A

Congratulations on purchasing the Akrapovič exhaust system. The Akrapovič exhaust system is a product of Akrapovič d.d., Malo Hudo 8a, 1295 Ivančna Gorica, Slovenia ("Akrapovič").

Please read this entire installation manual carefully prior to installing and using the Akrapovič exhaust system.

Akrapovič exhaust system should only be installed by persons skilled in car exhaust system installation and performance. The instructions provided in this manual should be followed to ensure proper installation and safe use of the Akrapovič exhaust system. Akrapovič and/or its partners shall not be held liable for any damage or personal injury (including direct, indirect, or consequential damage) sustained as a result of improper installation of the Akrapovič exhaust system or its use and maintenance contrary to the instructions and warnings contained herein.

If you have any questions regarding the installation and/or proper use of the Akrapovič exhaust system or this manual, please contact your local Akrapovič partner.

For more information on the Akrapovič exhaust systems, see the official Akrapovič website at: <http://www.akrapovic.com>

GENERAL INFORMATION

Your safety is our number one priority. Please drive your car responsibly, safely and always obey local traffic rules.

All statements made with regard to the exhaust system's compliance are made in respect of the exhaust system "as is". Any modifications of the Akrapovič exhaust system or its improper installation, use or maintenance that is not in accordance with this Installation manual, may result in severe damage to the exhaust system and/ or engine, as well as personal injury, and may affect the exhaust system's compliance with the legal requirements, such as exhaust system's air and/ or noise emissions (as an example, the car may not be suitable for use on public roads any longer), as well as warranty coverage.

The exhaust system may only be used in accordance with relevant laws and regulations, including state and federal, where applicable.

Damage caused by improper installation, use and maintenance of the Akrapovič exhaust system is not covered by the Akrapovič warranty. Please refer to the enclosed warranty with regard to the terms of our warranty.

Technical specifications of Akrapovič exhaust systems and related products are subject to change without notice.

COPYRIGHT AND OTHER RIGHTS NOTICE

The Akrapovič trademark, including corporate logos and emblems, are subject to copyright as well as trademark rights of Akrapovič, its licensors, or third persons authorizing Akrapovič to use them.

Any reproduction, technical or other manipulation, translation, or other use of the copyright and/or trademark rights contained herein is prohibited without the explicit prior written consent of Akrapovič. The same especially applies to the entire contents of this manual and/or any of its parts, including but not limited to technical specifications, instructions, graphs, photographs, and so on included in this manual.

Akrapovič takes all copyright and other rights infringement cases under serious consideration. If you have any reason to believe that your exhaust system is not an original Akrapovič product, please contact our local partners or Akrapovič at info@akrapovic.com.

SAFETY AND COMPLIANCE WARNING, PLEASE READ CAREFULLY

BEFORE REMOVING THE STOCK EXHAUST SYSTEM AND BEGINNING THE INSTALLATION OF YOUR NEW AKRAPOVIČ EXHAUST, PLEASE MAKE SURE THAT ALL ITEMS LISTED BELOW ARE VERIFIED:

- This manual is specific to the car indicated on the cover page, for which it is designed. Installation procedures vary depending on the type of car. Please verify that the Akrapovič **exhaust system and this installation manual correspond to the type of your car.**
- The exhaust system can get extremely hot during and after it is used. Make sure not to touch the exhaust system until it is completely cool. **Allow the exhaust and engine to cool down before beginning installation.**
- Make sure the car is **securely positioned to prevent** damage to yourself and other, or the car.
- Please check the parts you received against the parts list available on our website (please use the QR code on the front page or look for “schematic view” in the respective product page on www.akrapovic.com). Make sure that you have **all the parts necessary for the installation** of your new Akrapovič exhaust system. If any of the parts is missing, please do not proceed with uninstalling your stock exhaust system/installing the Akrapovič exhaust system and contact the retailer where you purchased the Akrapovič exhaust system.
- Every exhaust system muffler has its unique serial number, which identifies the authenticity of the product. You can find the serial number on the muffler’s sleeve. Please refer to the **picture 1** below. Please verify that your exhaust system is an original Akrapovič product. If you have any doubts, please contact the reseller where you purchased the exhaust system or Akrapovič partners. This manual, any certificates and Akrapovič warranty apply to original products only.

GENERAL NOTE

Photographs and other illustrations in this manual are symbolic and are intended to help represent individual steps for proper installation and use, as well as for a general overview. The actual component parts of the Akrapovič exhaust system may not entirely correspond to the photographs and other illustrations.

Picture 1 - Serial Number Position

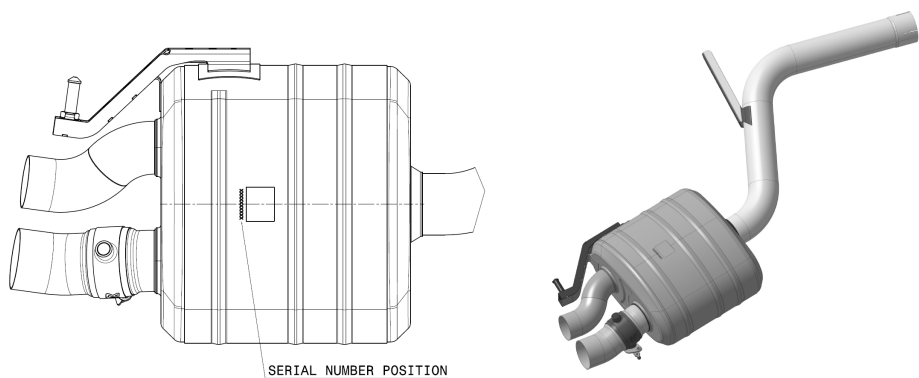

NOISE AND EMISSION WARNINGS

General warning

Because of the world-wide distribution of Akrapovič d.d. products, neither Akrapovič d.d. nor any of its subsidiaries make any representation that the exhaust system complies with the air and/or noise emissions laws, or labeling laws, of any jurisdiction. The purchasers are entirely responsible for informing themselves of the applicable laws where the products are to be used and to comply with those law.

Although legal compliance of Akrapovič products in a specific country should be determined by the user, you can find some basic guidance on compliance of your Akrapovič exhaust system with various legal requirements on the product-related part of our website (please use the QR code on the front page or look for the respective product page on www.akrapovic.com). For EC and ECE type approvals, please refer to the certificate enclosed to your product.

USA WARNING

Various U.S. states and the U.S. federal government have individual laws regulating the use of aftermarket exhaust parts and systems, especially as those parts and systems modify, remove, or replace original equipment catalysts. Please consult the appropriate laws in your area before installing any aftermarket part or system on your vehicle to ensure compliance with all applicable laws. Neither Akrapovic d.d. nor any of their subsidiaries or the sellers of the parts or systems make any representation that any of their parts or systems comply with any such laws.

CALIFORNIA WARNING

California laws prohibit the use of any aftermarket exhaust part or system that modifies, removes or replaces original equipment catalysts unless the California Air Resources Board has issued an Executive Order regarding such part or system or unless the part or system is exempted by being used only on racing vehicles on closed courses. Neither Akrapovic d.d. nor any of their subsidiaries make any representation that any of their parts or systems has received such an Executive Order or that any of their parts or systems conform with the racing vehicles exemption. The purchasers are entirely responsible for informing themselves of applicable California laws and to comply with those laws.

SYMBOLS

The following symbols are used throughout these installation instructions:



**TOOLS AND PROTECTIVE
EQUIPMENT REQUIRED**



TIGHTENING TORQUE



LUBRICATION



HAND TIGHTEN



INSTALLATION TIP



CAUTION OR IMPORTANT

USE BOLT SEALANT

Apply 3 to 4 small drops of bolt sealant onto the cleaned and degreased threads before tightening the bolts.

WARNING! Avoid contact with skin, eyes and mucous membranes. Do not inhale fumes. Keep out of reach of children.



USE ANTI-SEIZE LEAD-FREE COPPER PASTE (black tube)

Provides trouble-free and long-lasting protection against seizing, corrosion and rusting of bolts, threaded ends, nuts, joints, etc. Also protects against vibration, wear and impact. **WARNING! Avoid eye contact. Keep out of reach of children.**



USE ANTI-SEIZING GREASE (white tube)

Prevents seizing, corrosion and excessive wear between the titanium components of your exhaust system. **WARNING! Avoid eye contact. Keep out of reach of children.**



Tools & equipment



- mechanic gloves
- eye protection
- Pipe cutting tool
- Socket 15 mm
- Socket 18 mm
- T-handle 8 mm wrench
- T-handle 10 mm wrench
- Rubber bracket unhooking tool
- Flat screwdriver
- Cutting nippers

PARTS LIST

The following parts should be found in the box:

- Installation Manual
- Homologation certificate/ compliance documents if applicable
- Warranty
- Fitting material
- Muffler, pipes, Carbon Fiber components or Sound Kit components

Detailed list of parts can be found on the Akrapovič website (please use the QR code on the front page or look for "Schematic view" in the respective product page on www.akrapovic.com).

IMPORTANT: The car should be in the off position throughout the dismantling and installation process, as well as any other work done on the exhaust system!

REMOVAL OF STOCK EXHAUST SYSTEM:

The process of uninstalling the original exhaust system may vary depending on the existing exhaust system. Please follow the original exhaust system manufacturer's instructions for uninstalling the original exhaust system.

If you for any reason decide otherwise, please note that any information provided in this respect herein should be considered as general information provided for your convenience only. Akrapovič shall not assume any liability or responsibility with regard to uninstalling your existing exhaust system, warranty coverage of such exhaust system or vehicle or their further fitness for use.

In case your Akrapovič exhaust system may not be used on certain roads or under certain conditions, please keep the stock or other exhaust system that you can use in such circumstances legally.

REMOVAL OF STOCK EXHAUST SYSTEM:

Put the vehicle onto a car lift.

! **CAUTION:** ensure that the car is lifted safely and properly in order to avoid the risk of vehicle damage, injury, or even death!

1. Unscrew the marked bolts, remove the chassis reinforcement, mark the exhaust system at the middle set of impressed dots, as shown, carefully cut the pipe at the cutting line, unscrew the muffler's rubber brackets, disconnect the exhaust valve connector, pull the inlet pipe's rubber bracket off the pin and carefully remove the muffler off the vehicle (F 01, 02, 03, 04, 05, 06, 07).

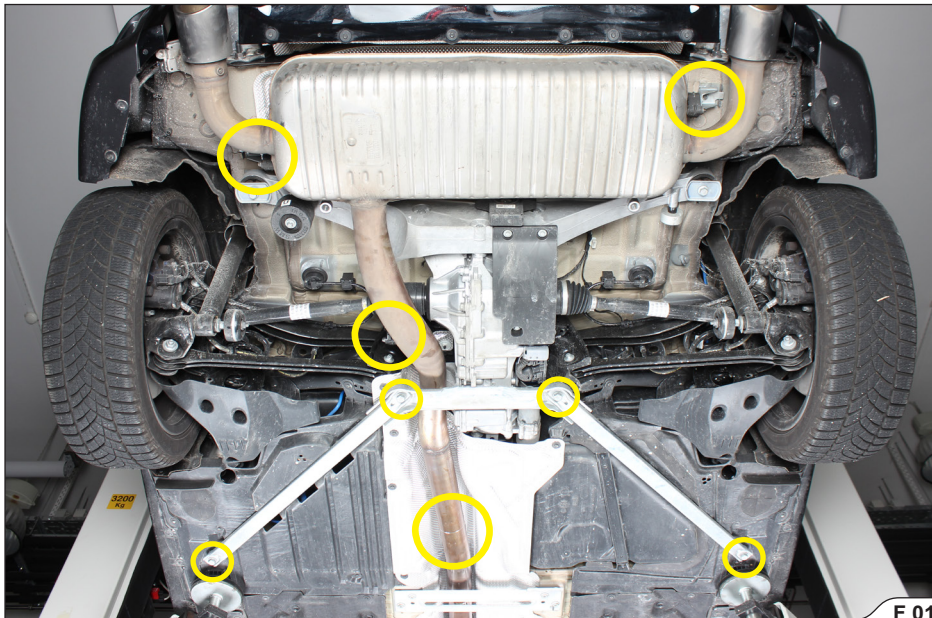

F 01

! CAUTION: make sure not to injure yourself or damage any part of the vehicle during this process!

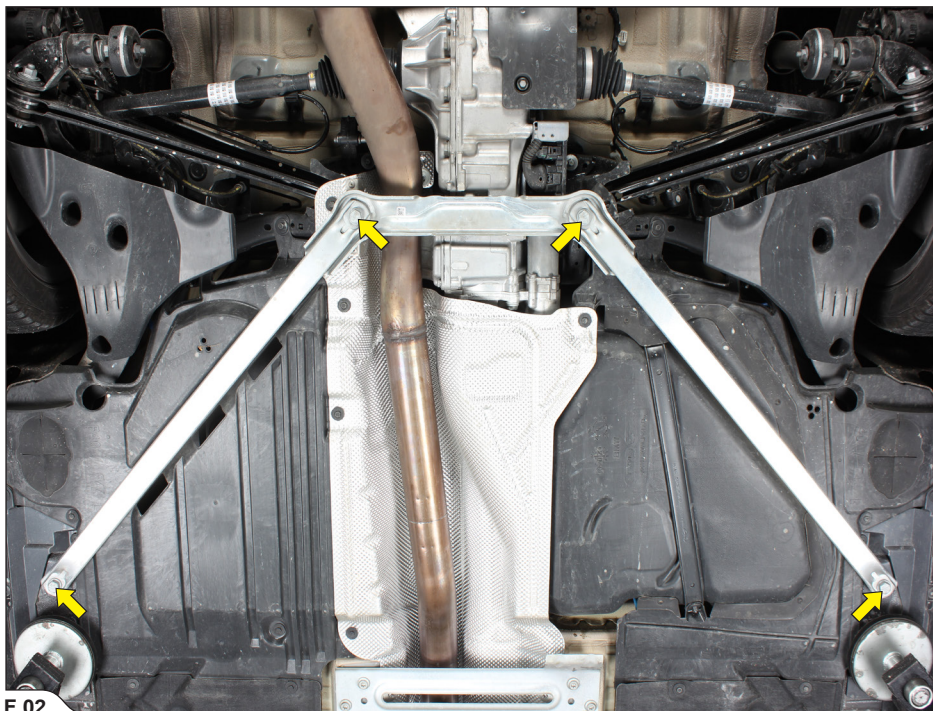

F 02



F 03

! CAUTION: make sure not to injure yourself or damage any part of the vehicle during this process!

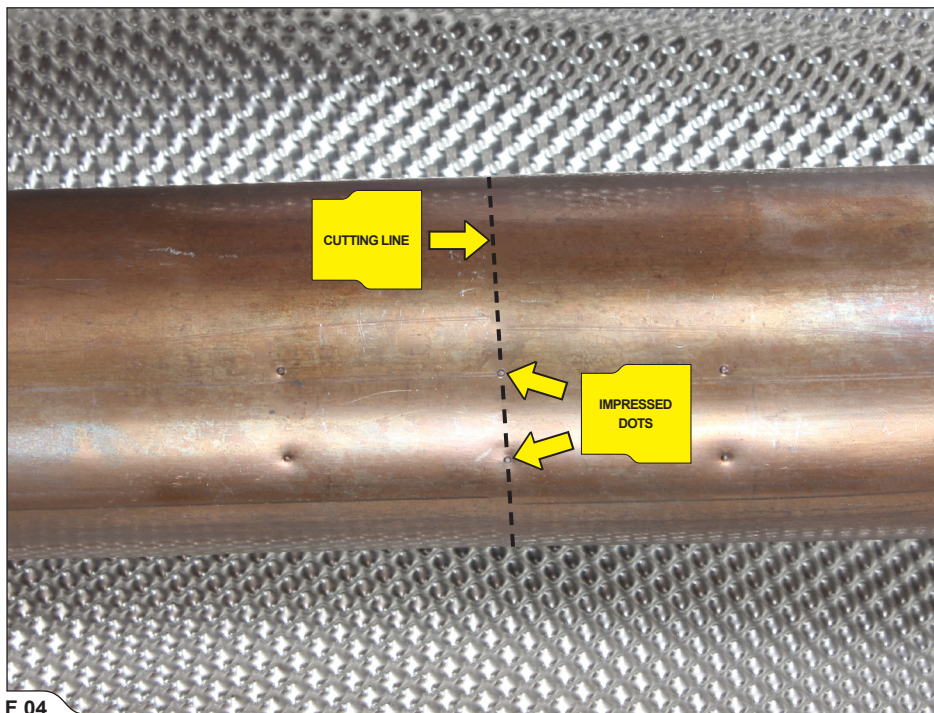

F 04

! **CAUTION:** support the muffler during this process or you could injure yourself or damage the vehicle!



F 05

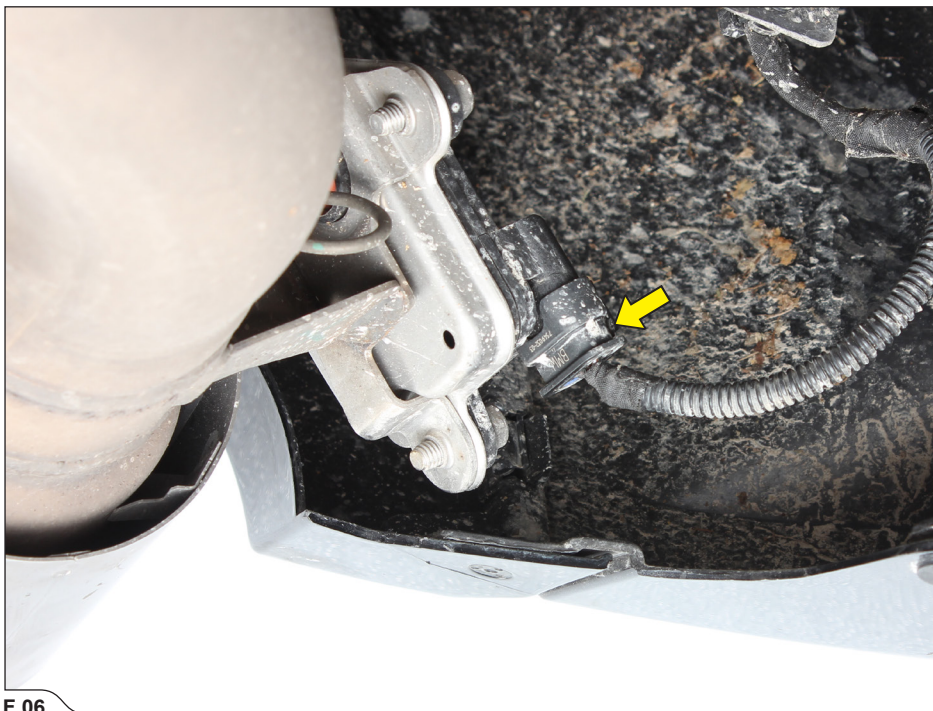

F 06

! **CAUTION:** support the muffler during this process or you could injure yourself or damage the vehicle!

✚ **INSTALLATION TIP:** for easier dismantling, lubricate the original rubber bracket (WD40®)*.
*WD-40® is a trademark of the WD-40 Company.

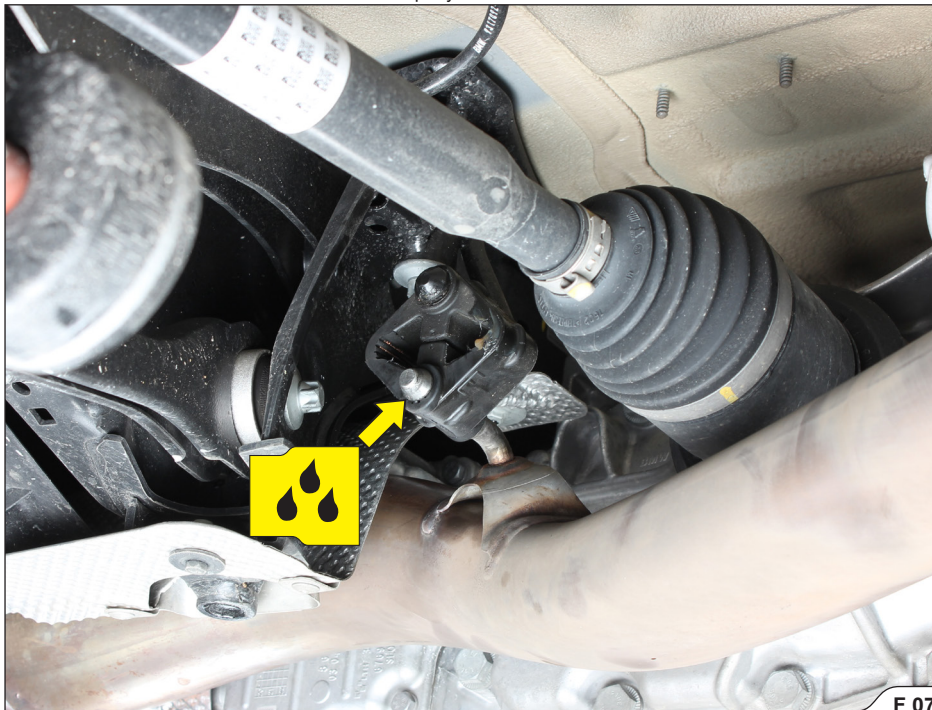

F 07

- Carefully remove the rubber brackets and unscrew exhaust valve's servo motor off the stock exhaust system (F 08, 09, 10).

✚ INSTALLATION TIP: for easier dismounting, lubricate the rubber brackets (WD40®)*.

*WD-40® is a trademark of the WD-40 Company.

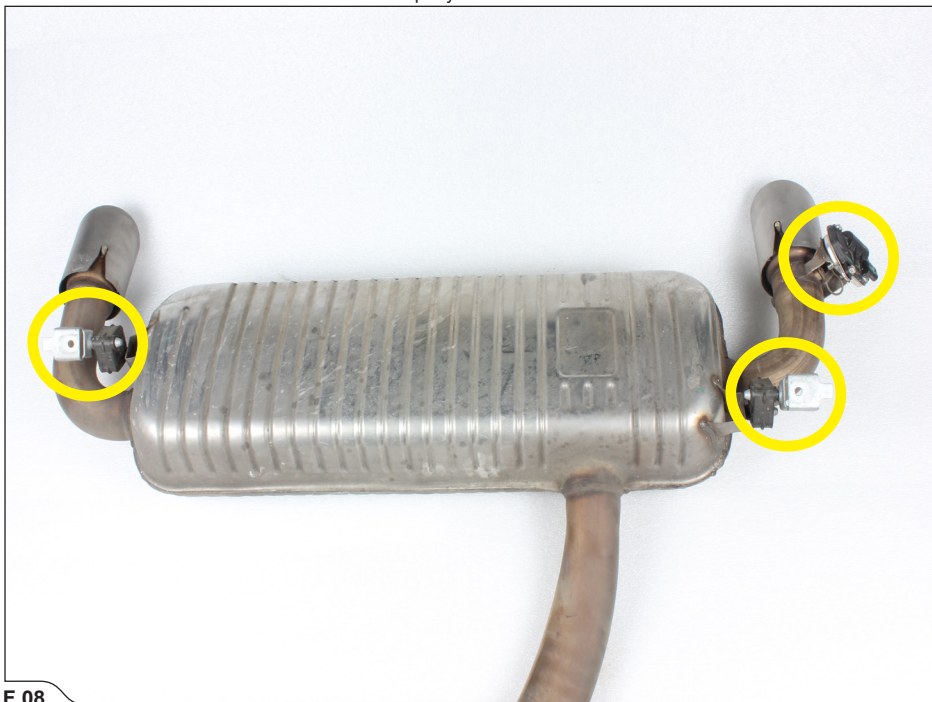

F 08

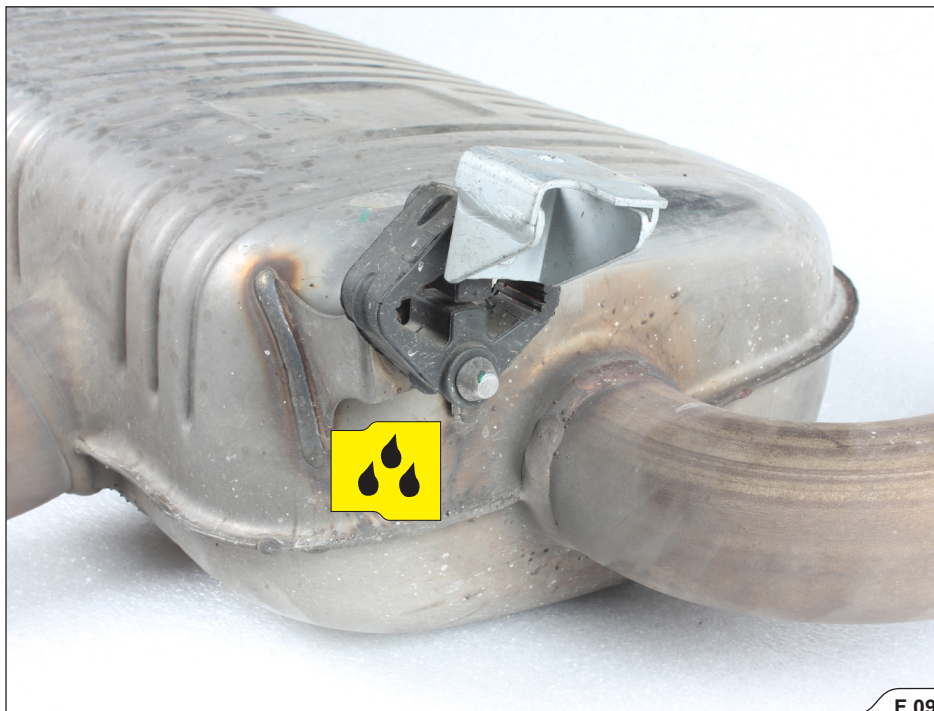

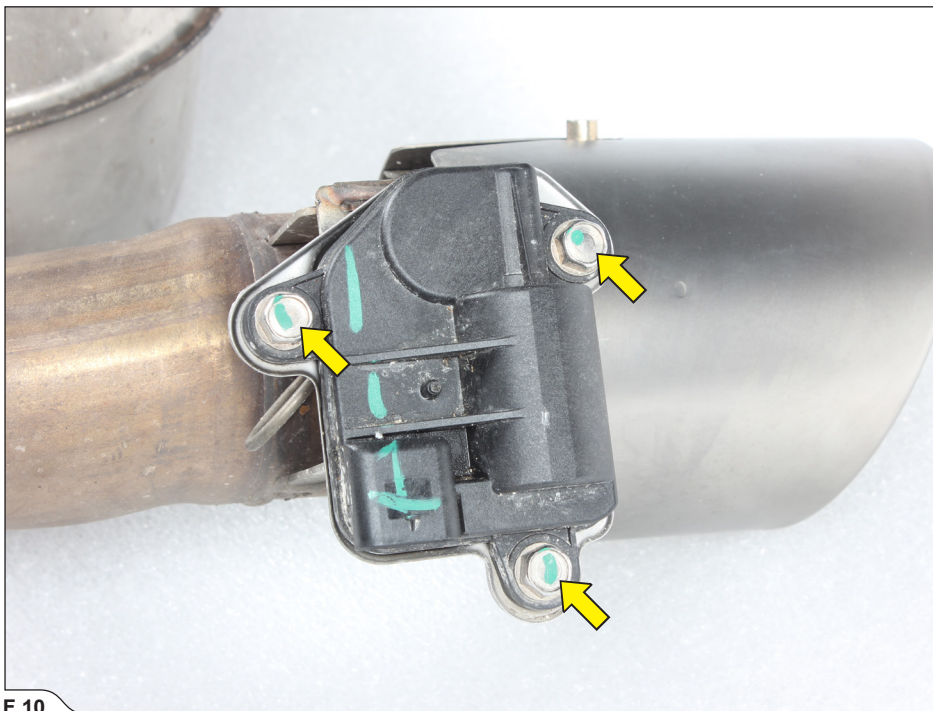

F 10

3. Open the trunk, remove the trunk floor panel, loading sill cover and left marked trunk trim panel to get access to electrical wiring harness; check vehicle manufacturer workshop manual for details For BMW M135i / X2 M35i only: (F 11, 12, 13, 14, 15, 16, 17, 18, 19, 20). For MINI JCW Clubman ALL4 / Countryman ALL4 only: (F 21, 22, 23, 24, 25, 26, 27, 28).

! CAUTION: make sure not to injure yourself or damage any part of the vehicle during this process!

BMW M135i

BMW X2 M35i



F 11

BMW M135i

BMW X2 M35i

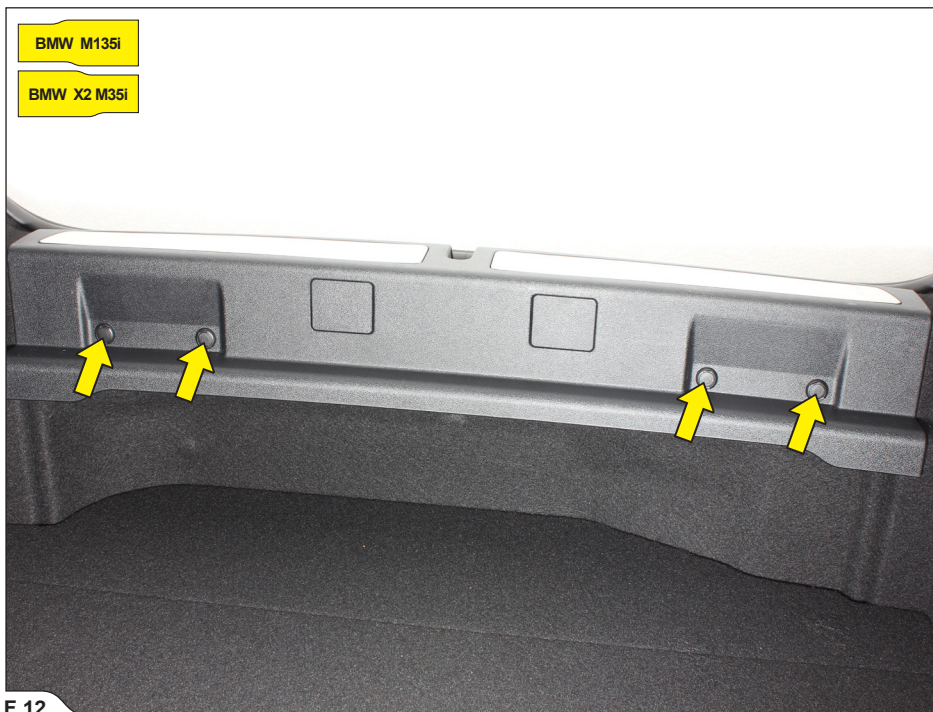

F 12

BMW M135i

BMW X2 M35i

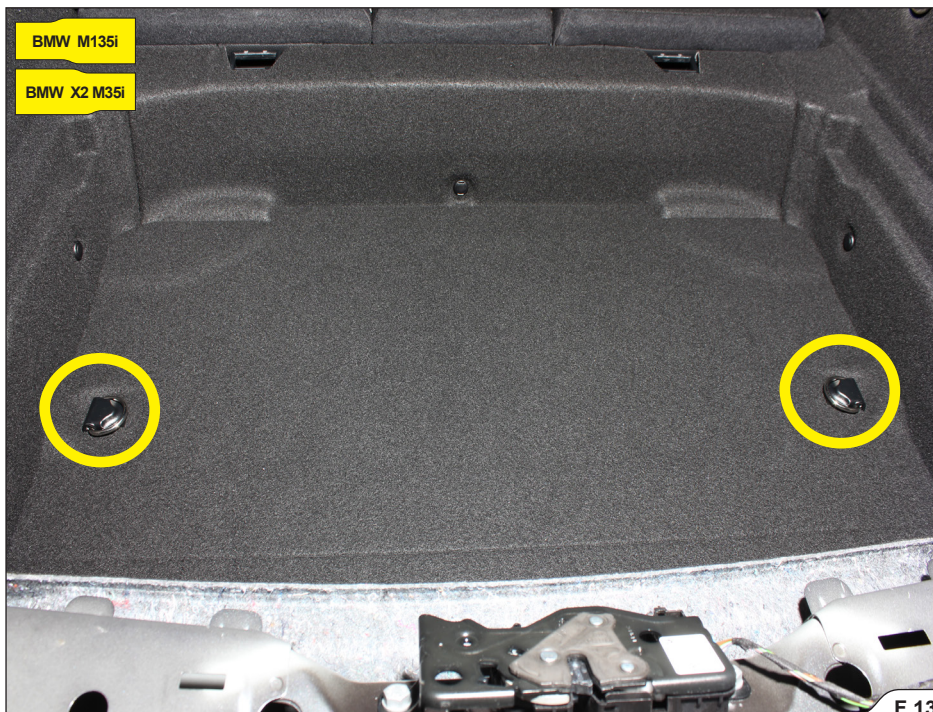

F 13

BMW M135i

BMW X2 M35i



F 14

BMW M135i

BMW X2 M35i

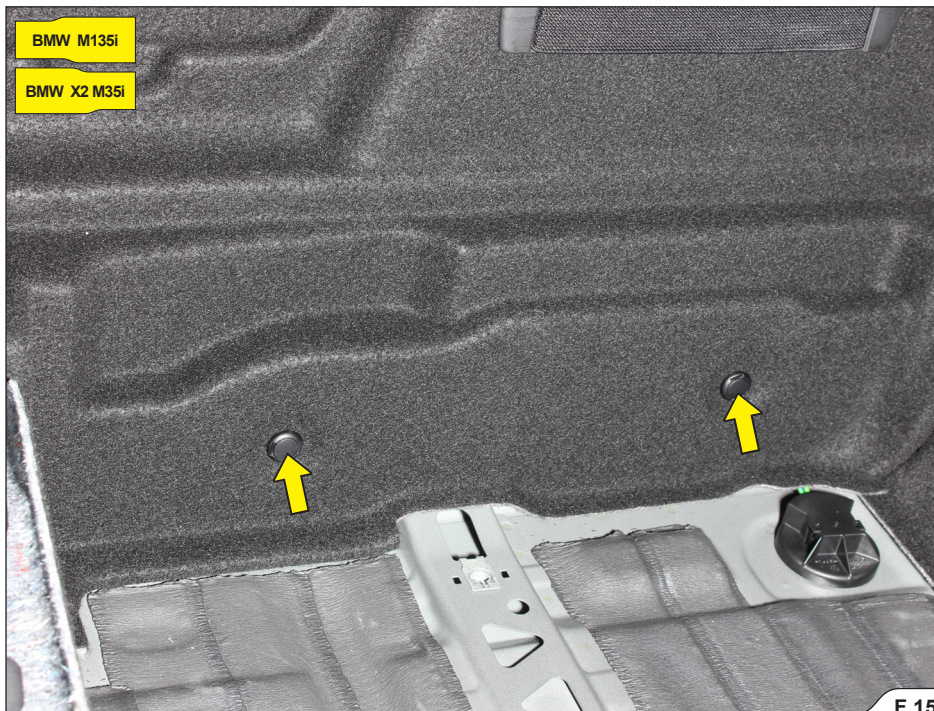

F 15

BMW M135i

BMW X2 M35i



F 16

BMW M135i

BMW X2 M35i

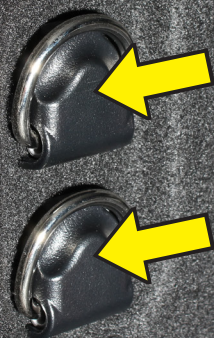

BMW M135i

BMW X2 M35i



F 18



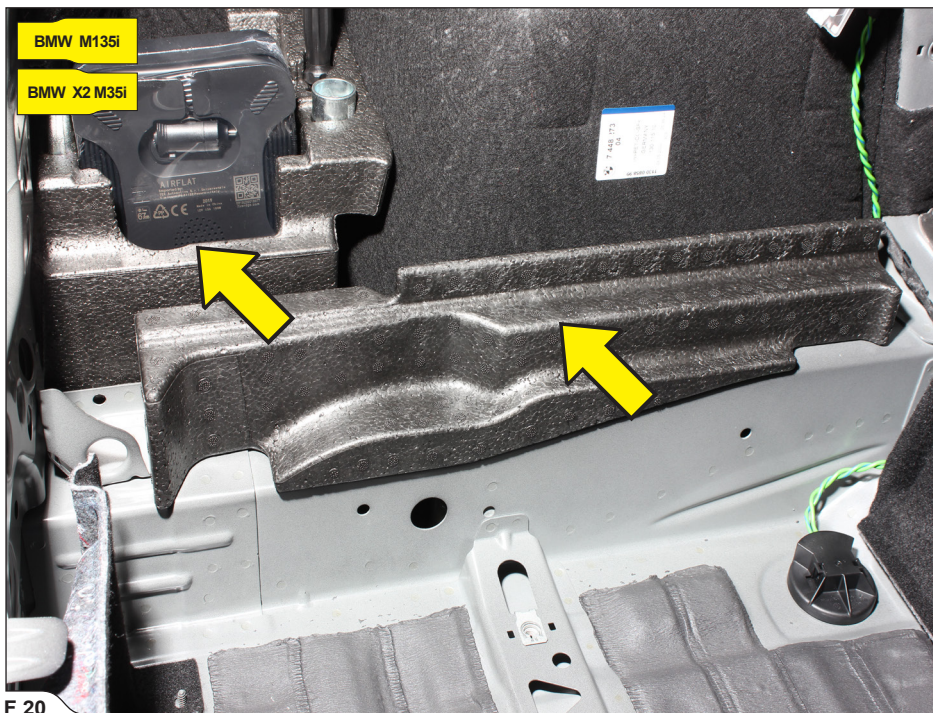



MINI Clubman

MINI Countryman

MINI Clubman

MINI Countryman



F 22



MINI Clubman

MINI Countryman



F 24

MINI Clubman

MINI Countryman



F 25

MINI Clubman

MINI Countryman



F 26

MINI Clubman

MINI Countryman

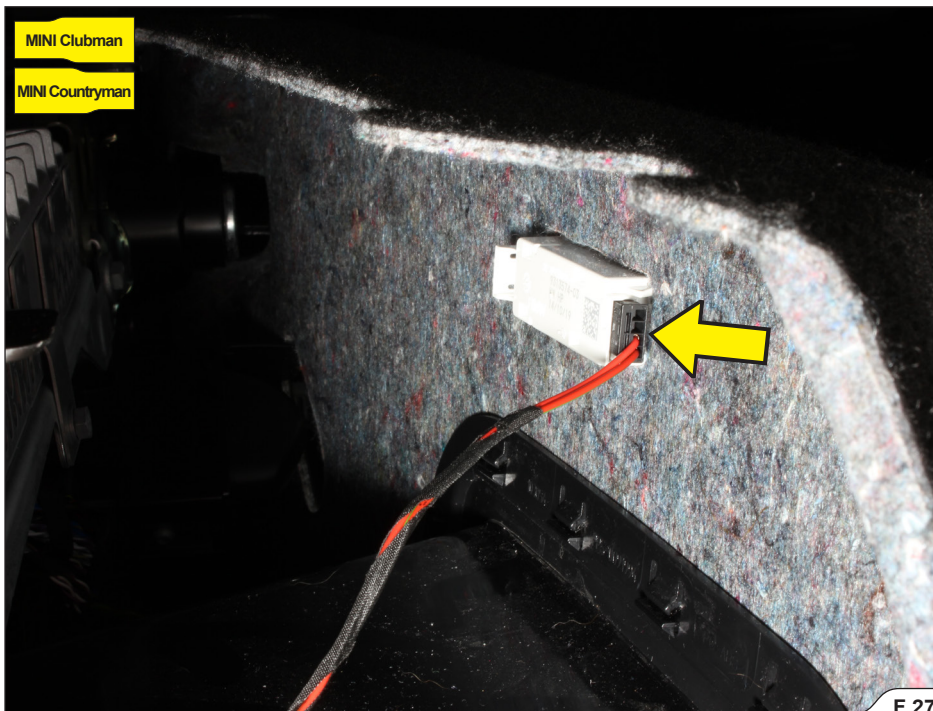

F 27

MINI Clubman

MINI Countryman

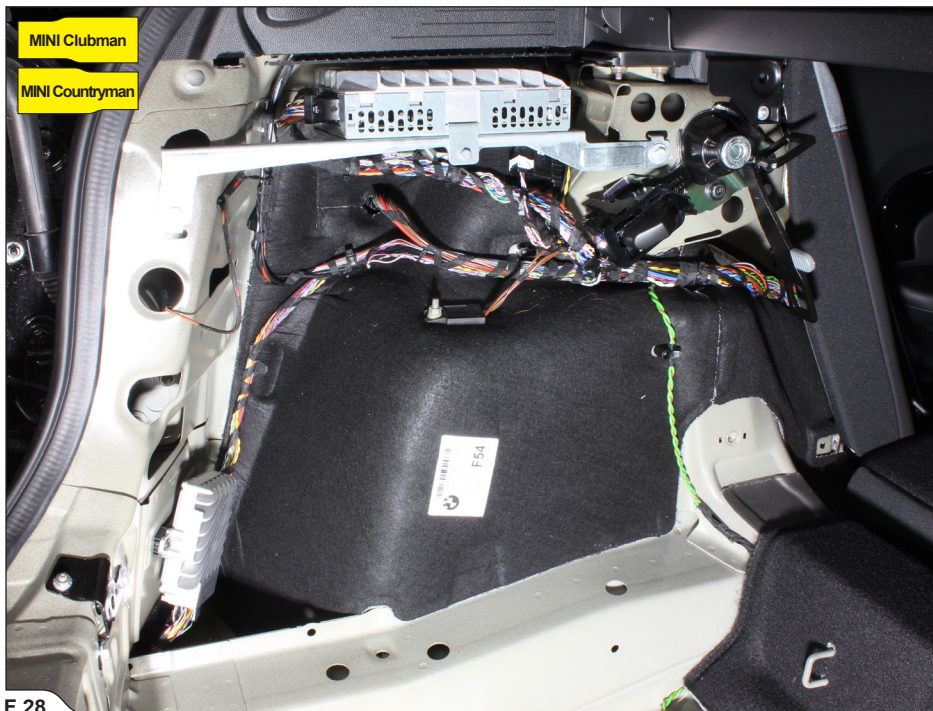

F 28

INSTALLATION OF THE AKRAPOVIČ EXHAUST SYSTEM:

1. The Control Kit components (F 29):

1 - Controller TNG

3 - To valve actuator

2 - CAN sniffer

4 - To stock valve connector

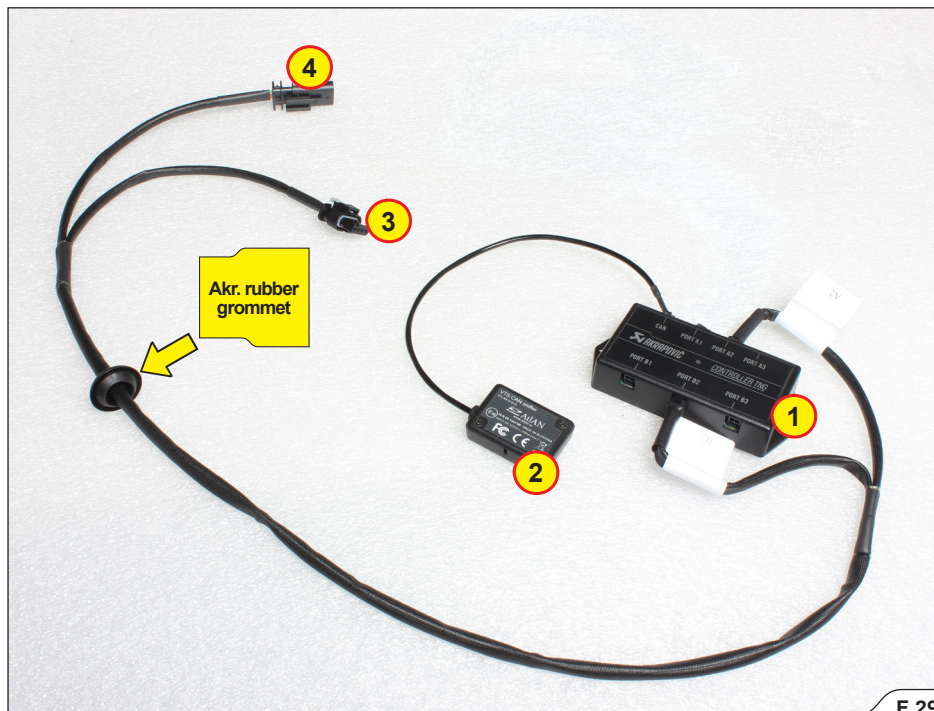

F 29

2. Disconnect the A2, B2 and CAN connectors from Controller TNG unit - the actuator's wiring harnesses must lead from the actuator into the trunk (F 30).

! **CAUTION:** make sure not to injure yourself or damage any part of the Control Kit!

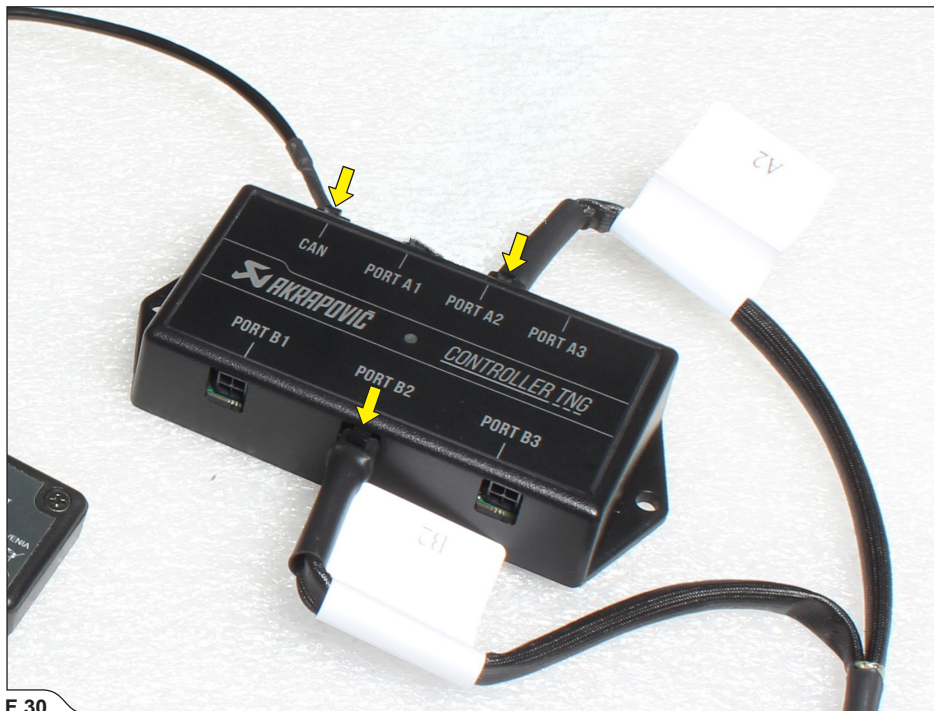

F 30

3. Remove the stock rubber grommet and lead the Akrapovič valve's harness into the trunk (make sure, that Akrapovič grommet plugs into place correctly) and connect the Akrapovič connector to the stock connector (F 31, 32).

! **IMPORTANT:** make sure not to damage the wires or connectors during this process!

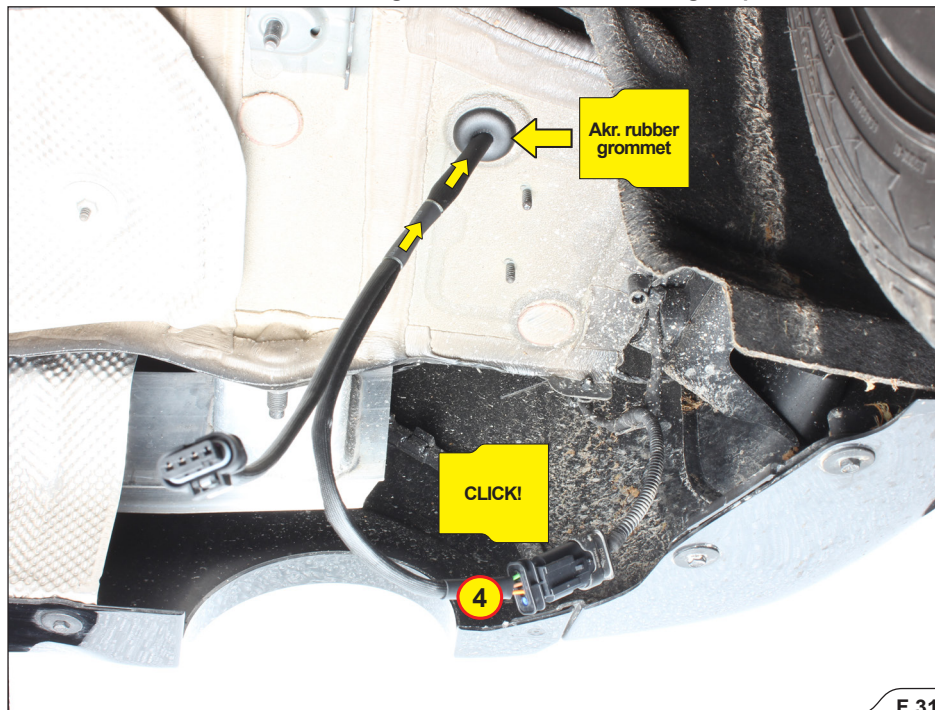

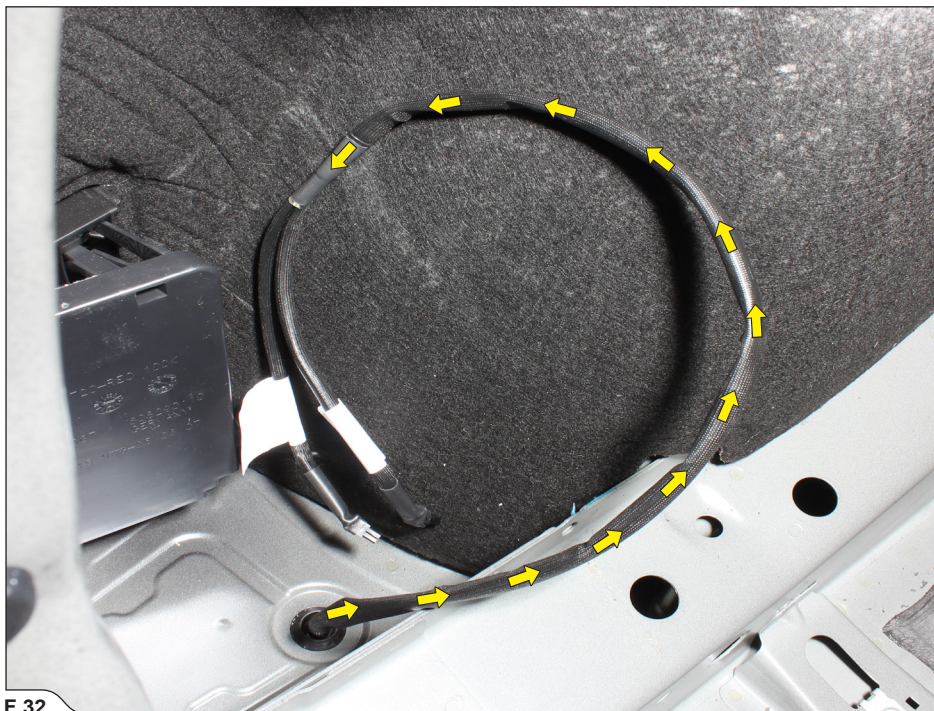

F 32

4. Install and connect the Controller TNG and CAN sniffer components in the trunk, as shown; secure all wiring and components in place using tie wraps from Akrapovič installation kit:

For BMW M135i only: (F 33, 34, 35, 36).

For BMW X2 M35i only: (F 37, 38, 39, 40).

For MINI JCW Clubman ALL4 / Countryman ALL4 only: (F 41, 42, 43, 44).

! IMPORTANT: make sure to secure all Control Kit components in such a way, that they won't touch any hot or moving parts of the vehicle!

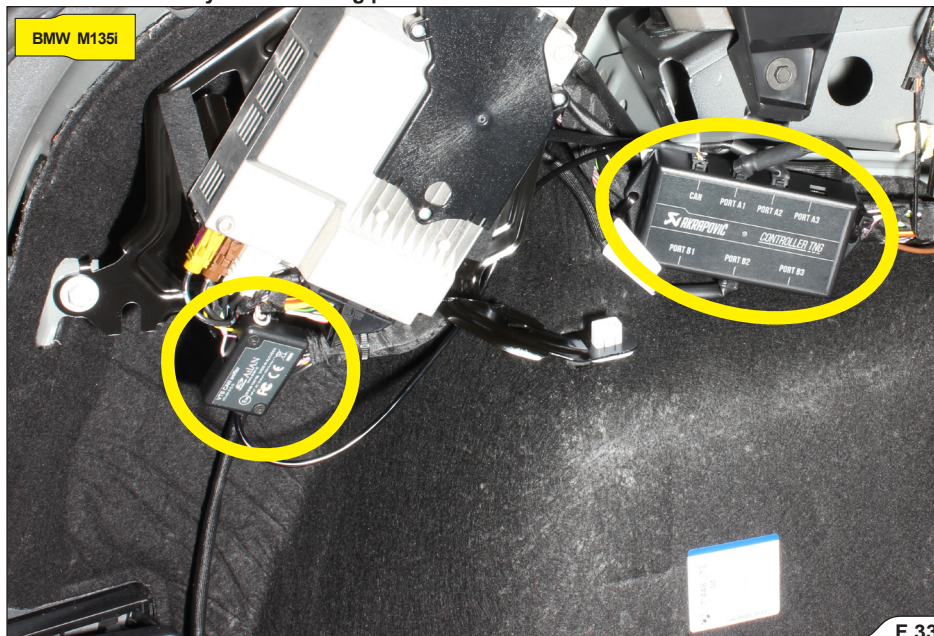

F 33

- ! **IMPORTANT:** carefully separate the PURPLE and WHITE wires from the stock harness, unscrew the CAN sniffer's cover, lead the purple and white wires through the CAN sniffer's wire grooves as shown and reinstall the cover (F 34, 35).
- ! **IMPORTANT:** make sure not to damage the wires during this process (F 34)!

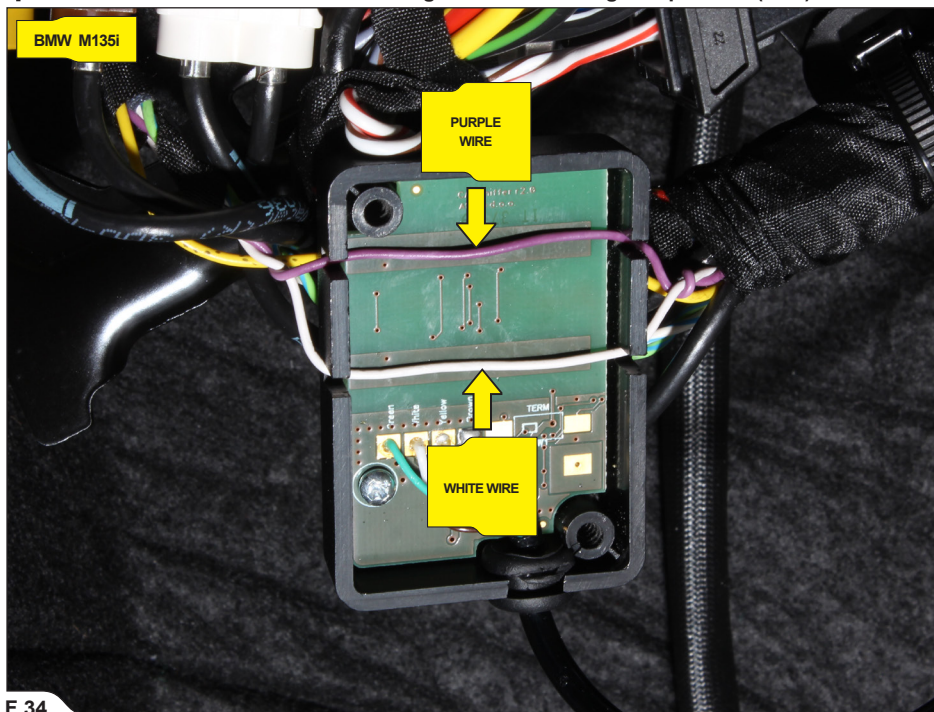

F 34

BMW M135i

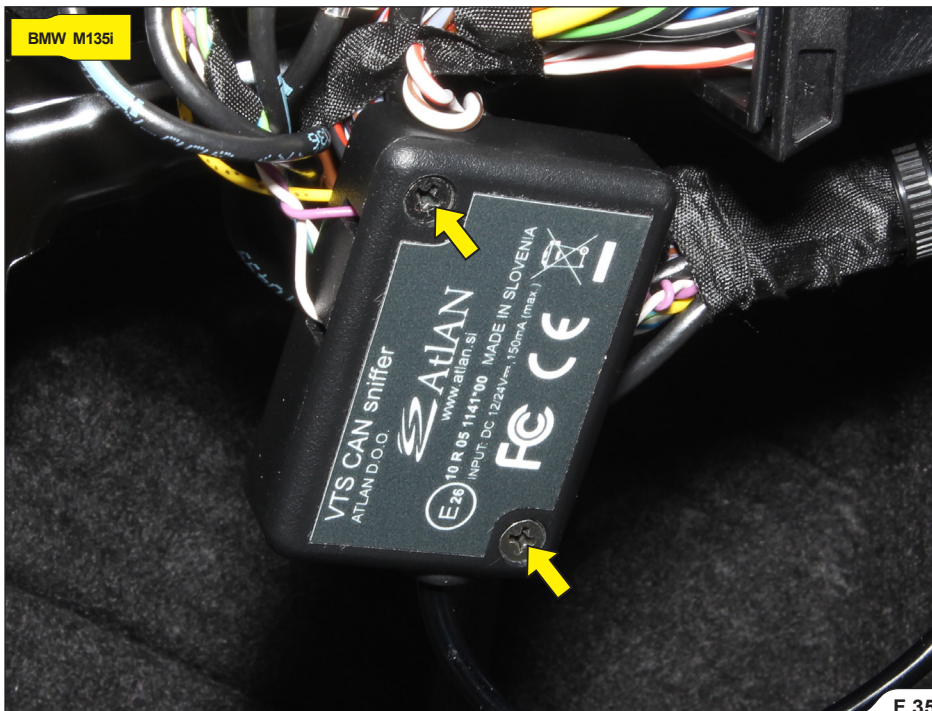

F 35

BMW M135i

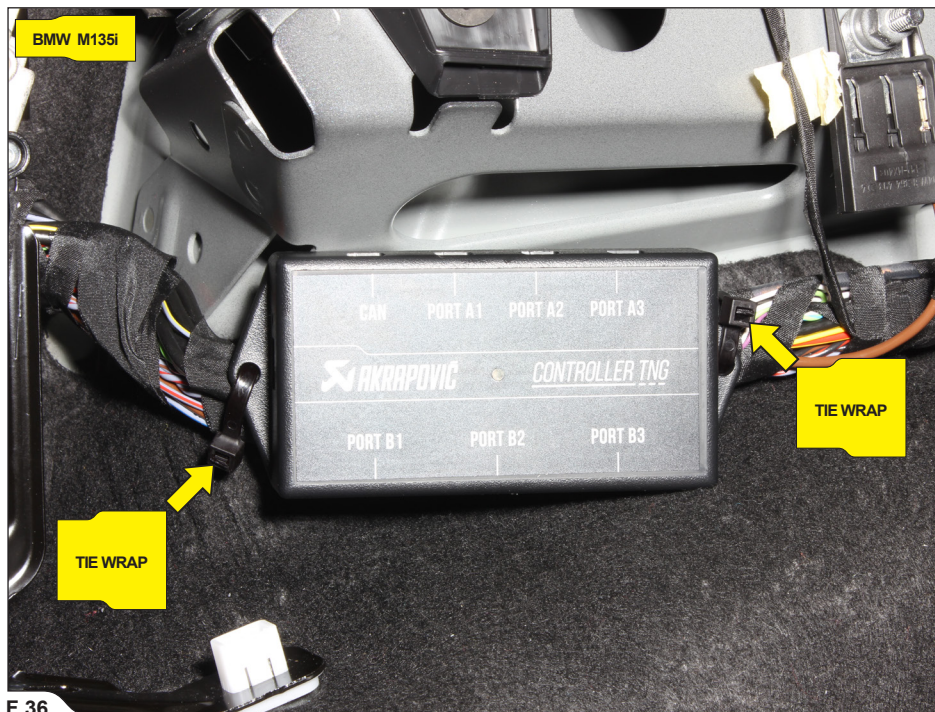

F 36

BMW X2 M35i

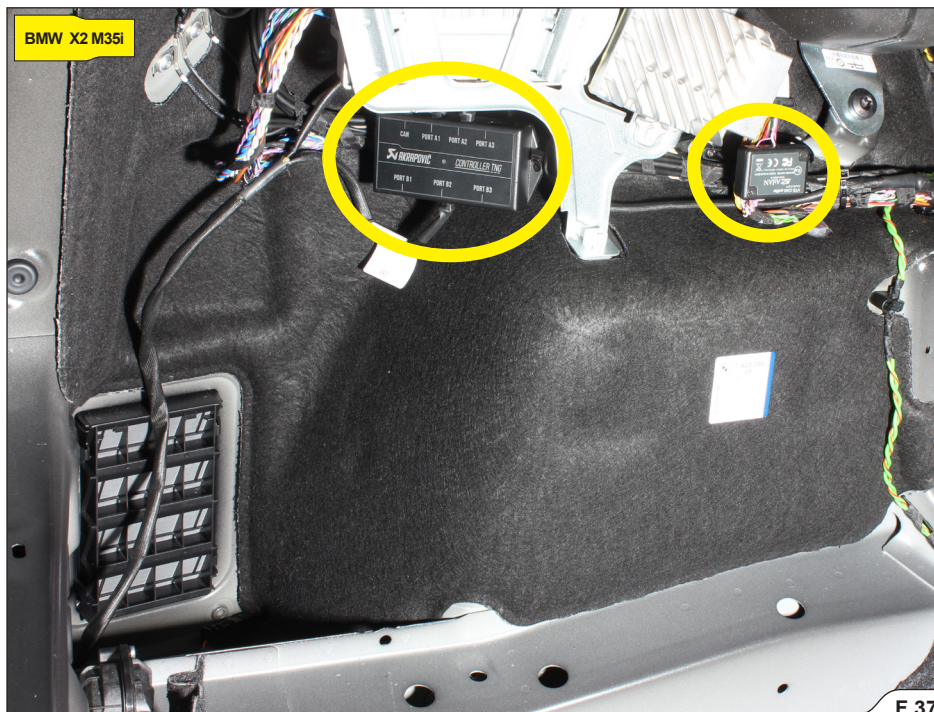

F 37

! **IMPORTANT:** carefully separate the PURPLE and WHITE wires from the stock harness, unscrew the CAN sniffer's cover, lead the purple and white wires through the CAN sniffer's wire grooves as shown and reinstall the cover (F 38, 39).

! **IMPORTANT:** make sure not to damage the wires during this process (F 38)!

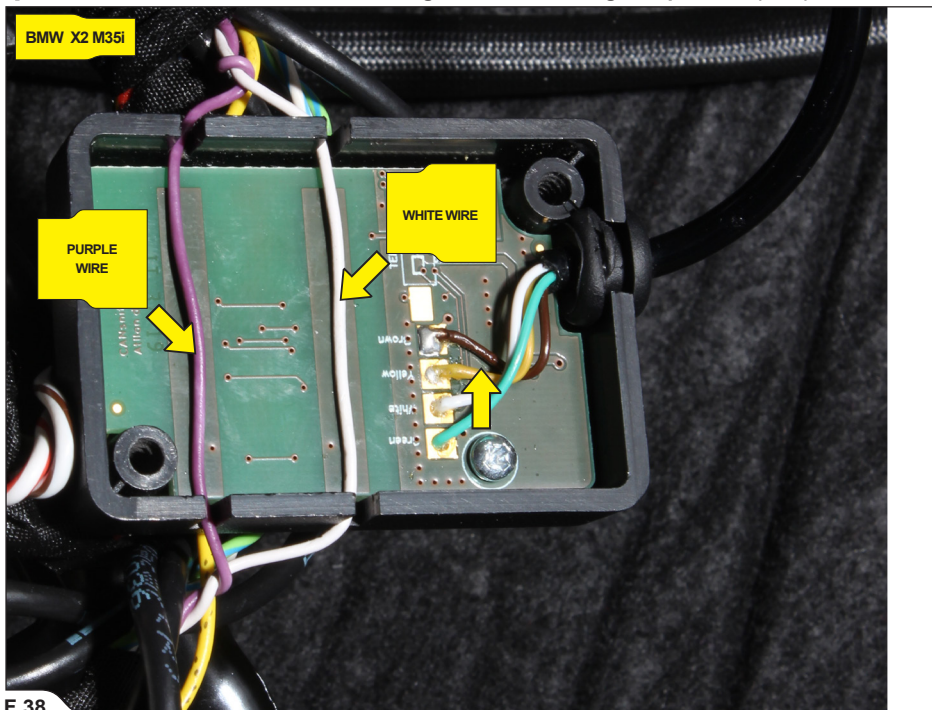

F 38

BMW X2 M35i

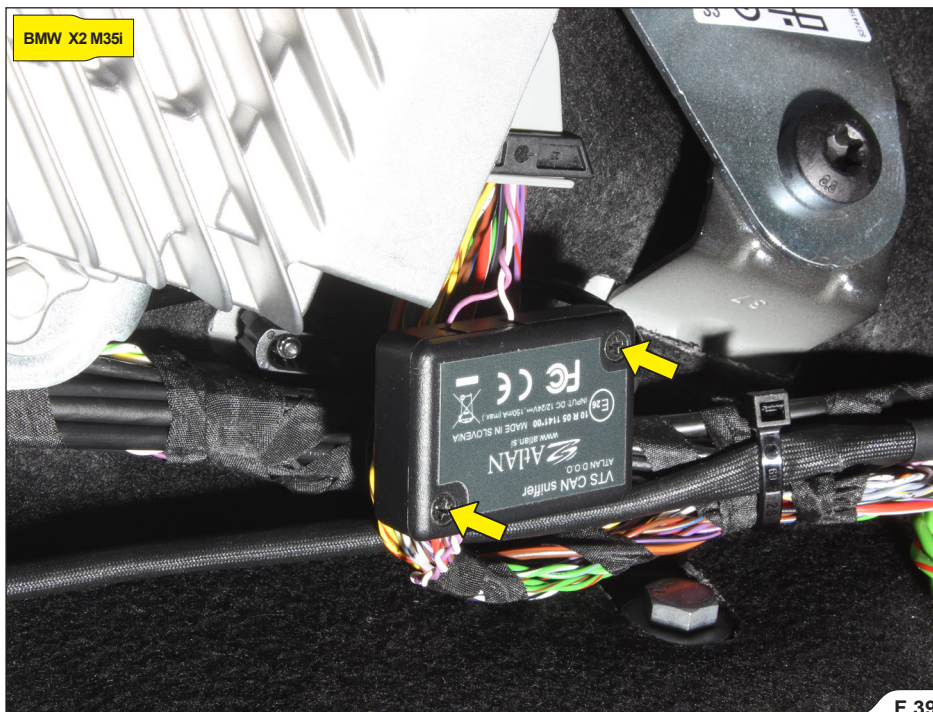

BMW X2 M35i

CAN

PORT A1

PORT A2

PORT A3

AKRAPOVIČ

CONTROLLER TNG

PORT B1

PORT B2

PORT B3

TIE WRAP

TIE WRAP

F 40

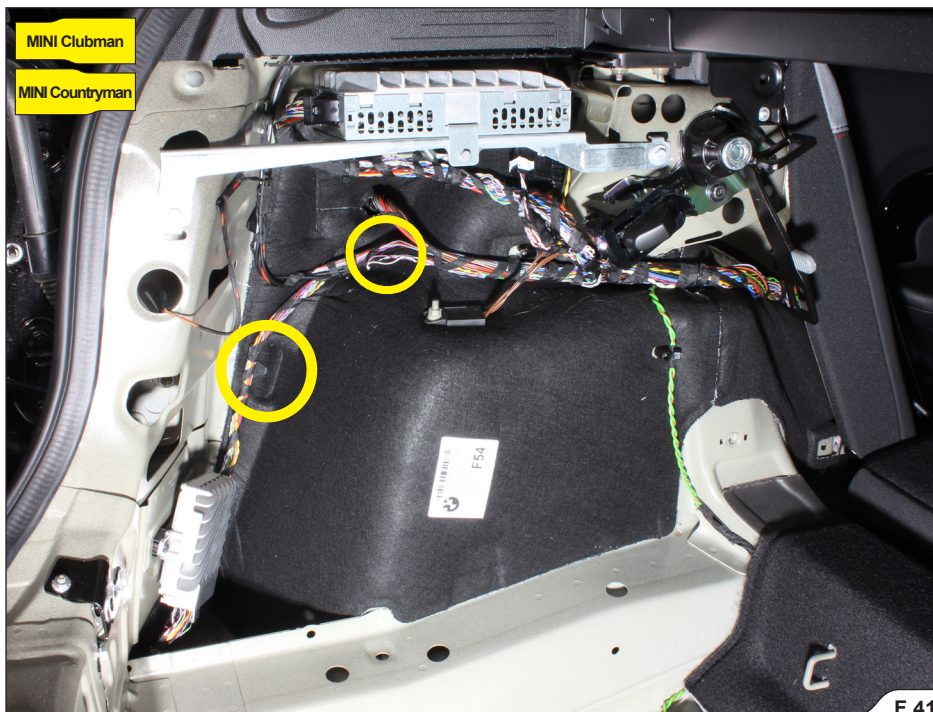

! **IMPORTANT:** carefully separate the PURPLE and WHITE wires from the stock harness, unscrew the CAN sniffer's cover, lead the purple and white wires through the CAN sniffer's wire grooves as shown and reinstall the cover (F 42, 43).

! **IMPORTANT:** make sure not to damage the wires during this process (F 42)!

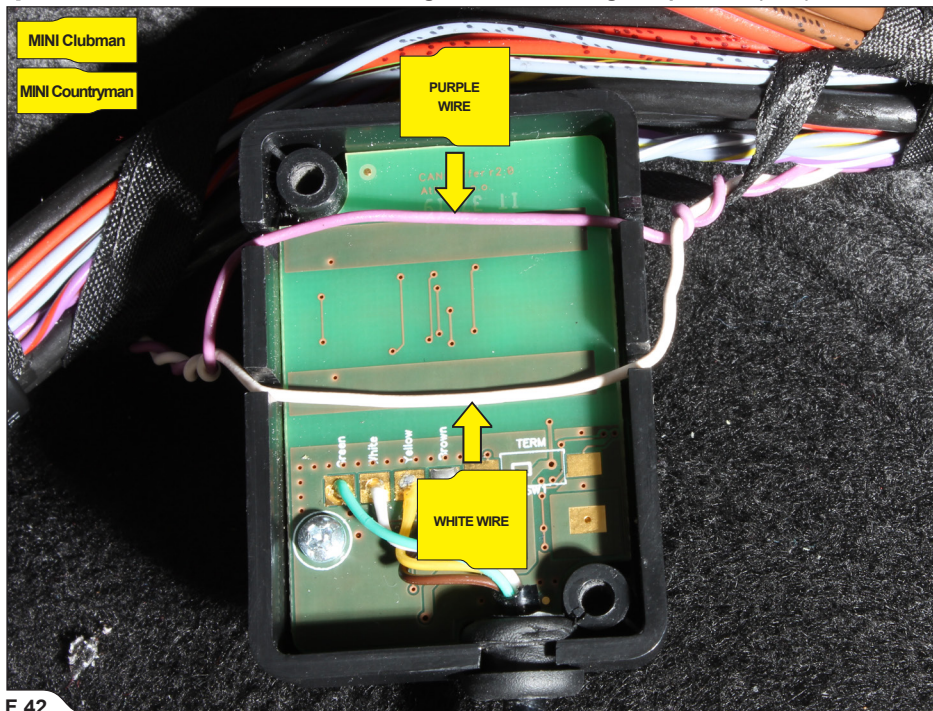

F 42

MINI Clubman

MINI Countryman



F 43

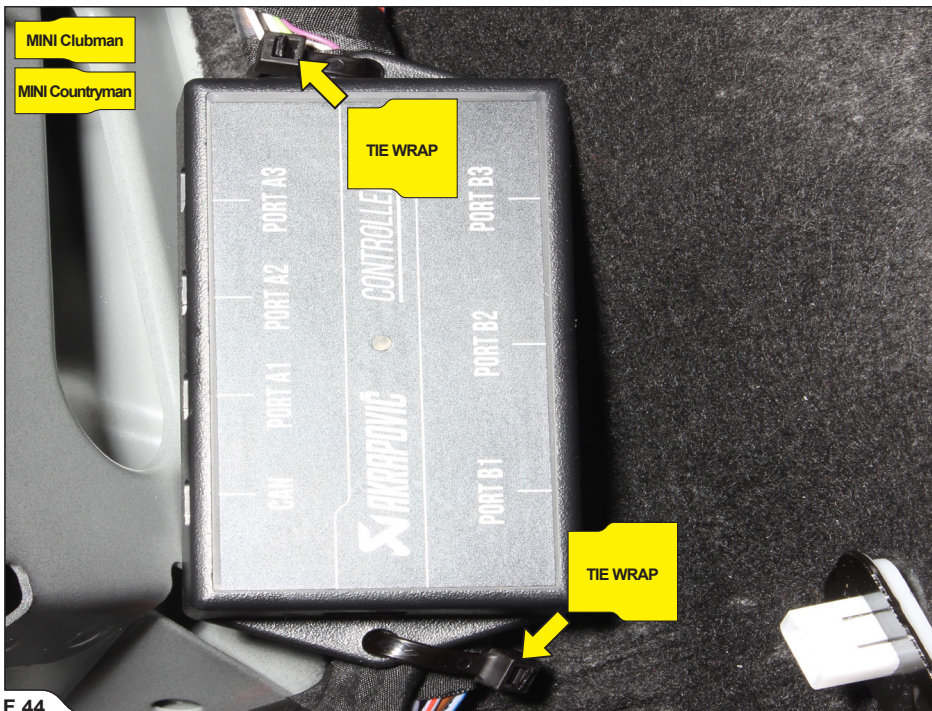

F 44

5. Connect the A2, B2 and CAN connectors to the Controller TNG unit (F 45).

! **CAUTION:** make sure not to injure yourself or damage any part of the Control Kit!

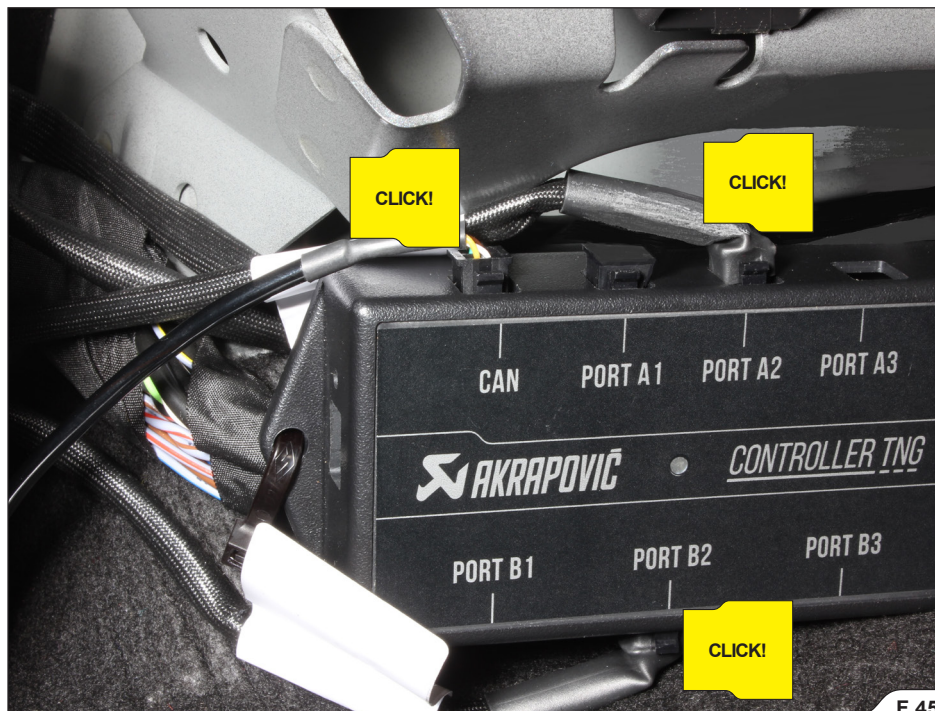

6. Install stock rubber brackets onto muffler, install stock actuator using Stock heat shield and Akrapovič spring connection and bolts (F 46, 47, 48, 49, 50).

! **CAUTION:** make sure not to injure yourself or damage any part of the vehicle during this process!



F 46

⚡ INSTALLATION TIP: for easier mounting, lubricate the rubber brackets (WD40®)*.
*WD-40® is a trademark of the WD-40 Company.

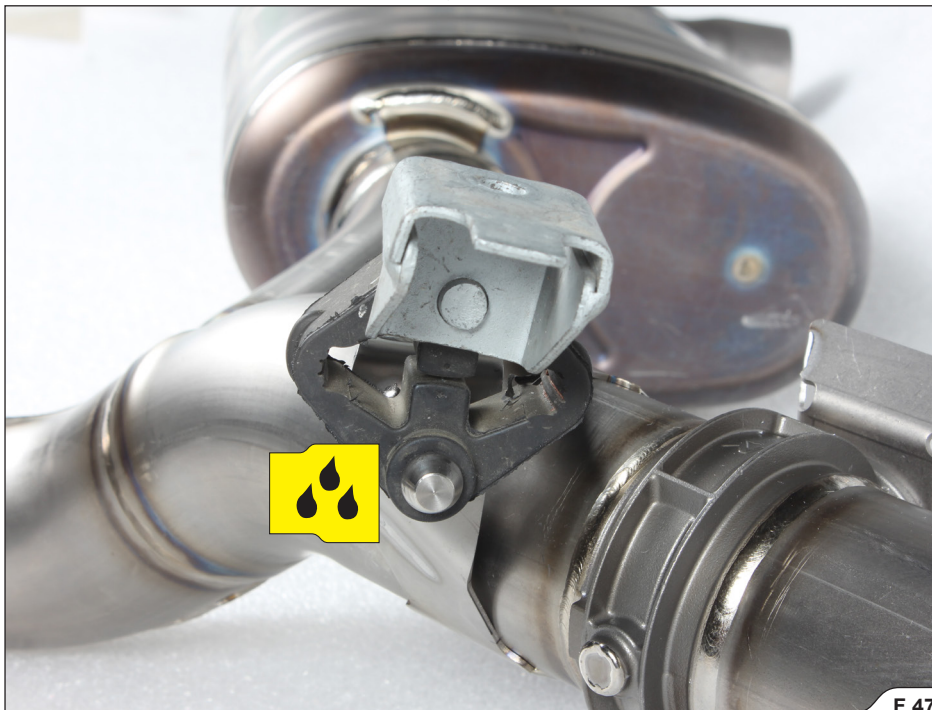

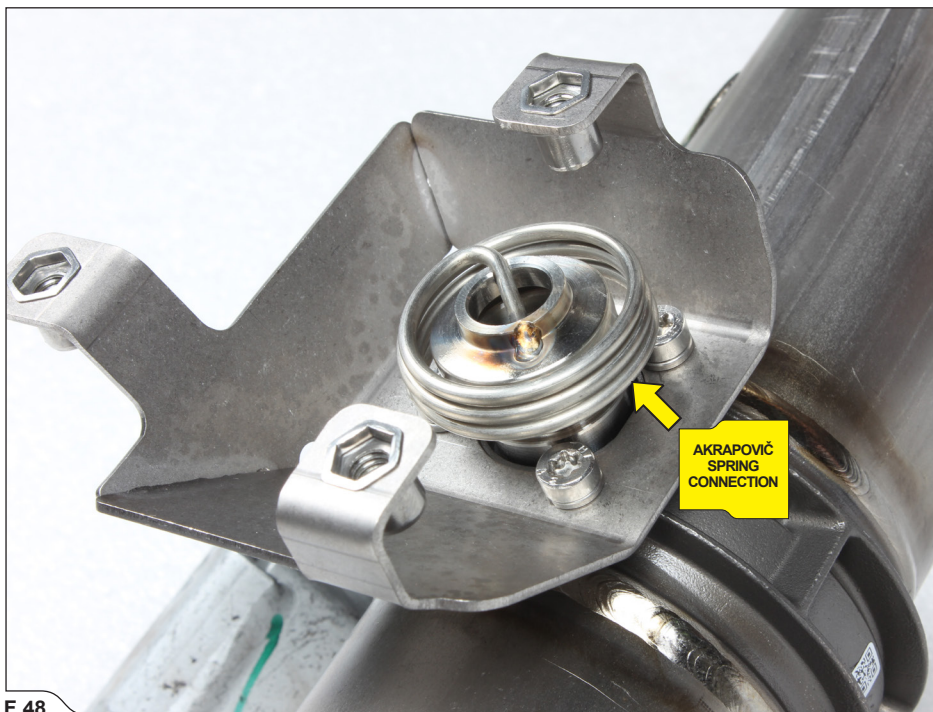

F 48

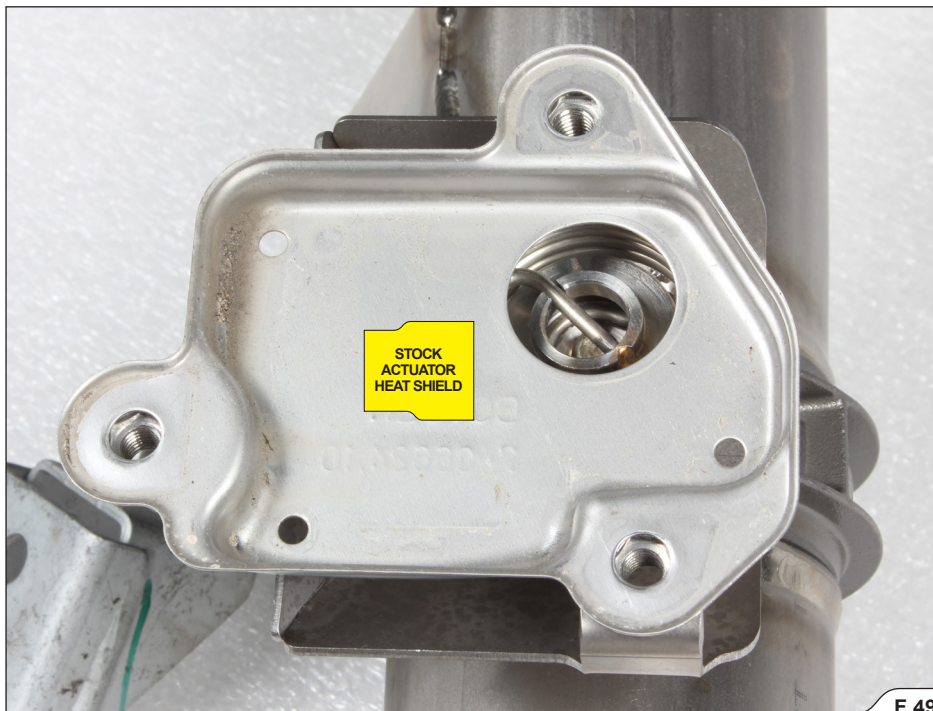

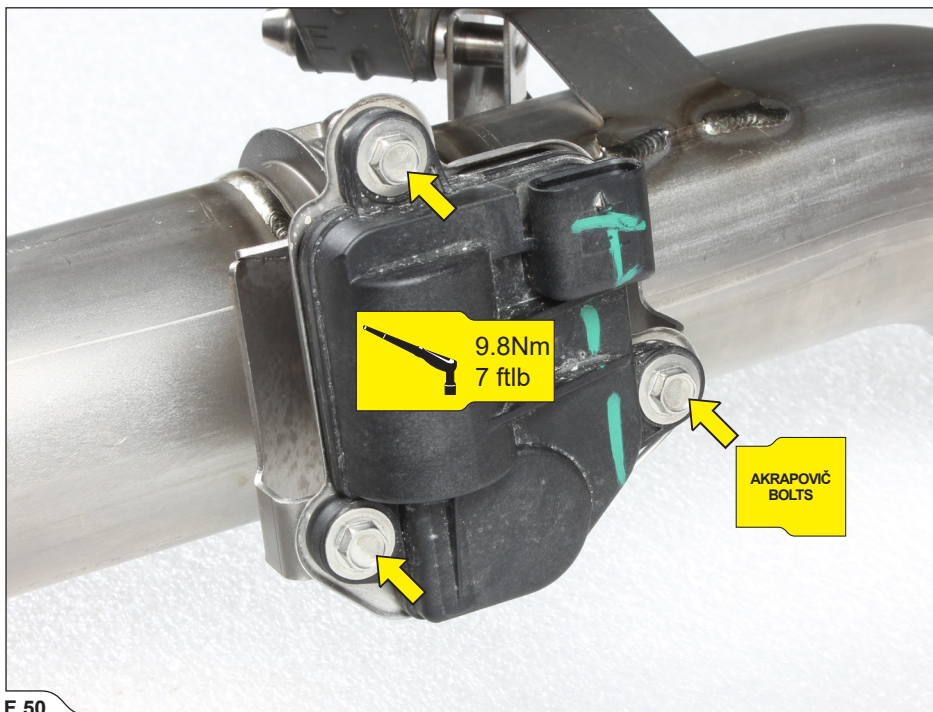

F 50

7. Slide the double clamp (Akrapovič installation kit) onto the stock pipe, as shown (F 51).

! **CAUTION:** make sure not to injure yourself or damage any part of the vehicle during this process!

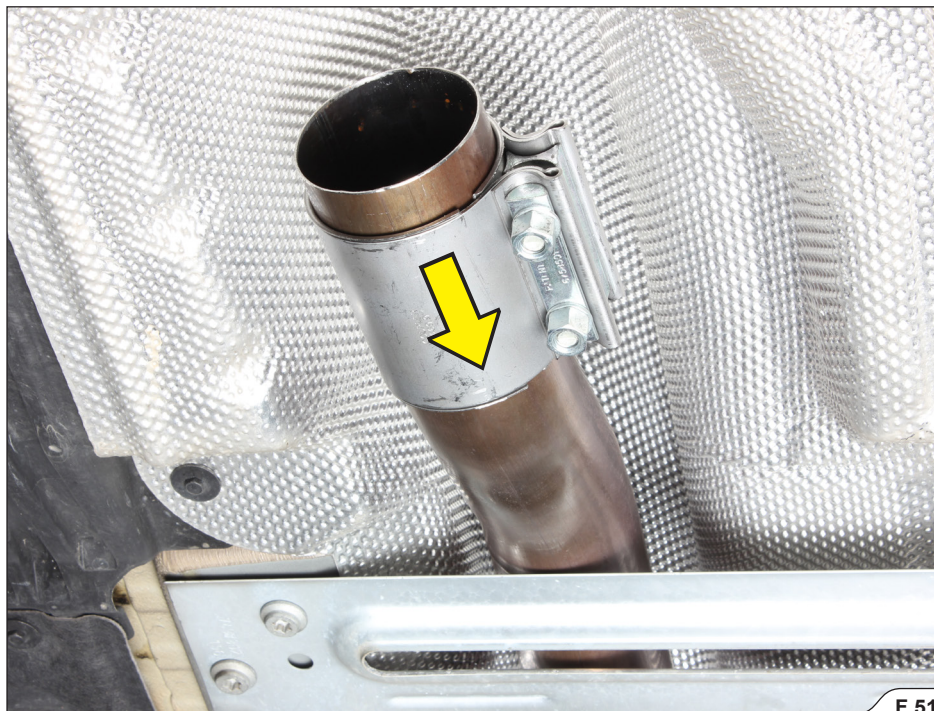

F 51

8. Carefully install the Akrapovič muffler onto the vehicle; tighten and attach all rubber brackets onto the chassis, align the muffler in respect to the chassis, center the double clamp in the middle of the joint, tighten the clamp to the specified torque and connect the Akrapovič connector to the valve's actuator (F 52, 53, 54, 55, 56).

! CAUTION: make sure not to injure yourself or damage any part of the vehicle during this process!

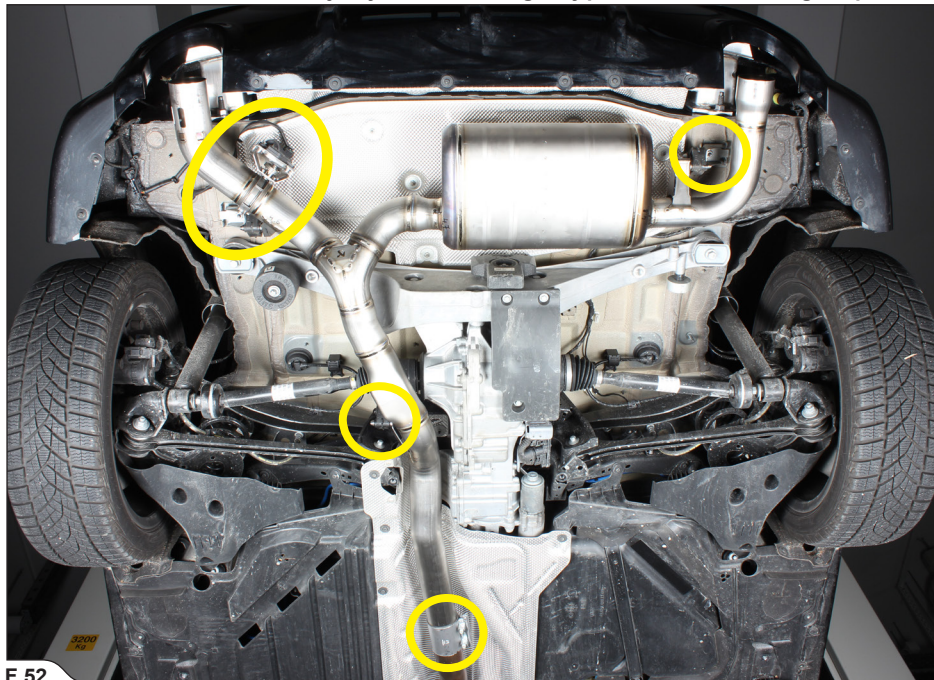

F 52

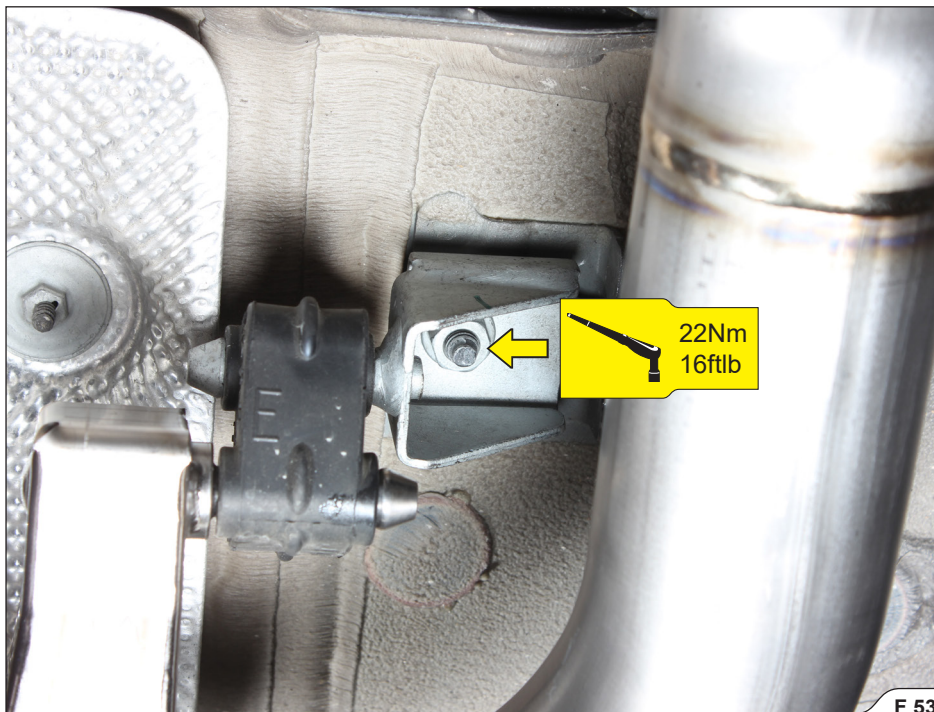

W **INSTALLATION TIP:** for easier mounting, lubricate the rubber bracket (WD40®)*.
*WD-40® is a trademark of the WD-40 Company.

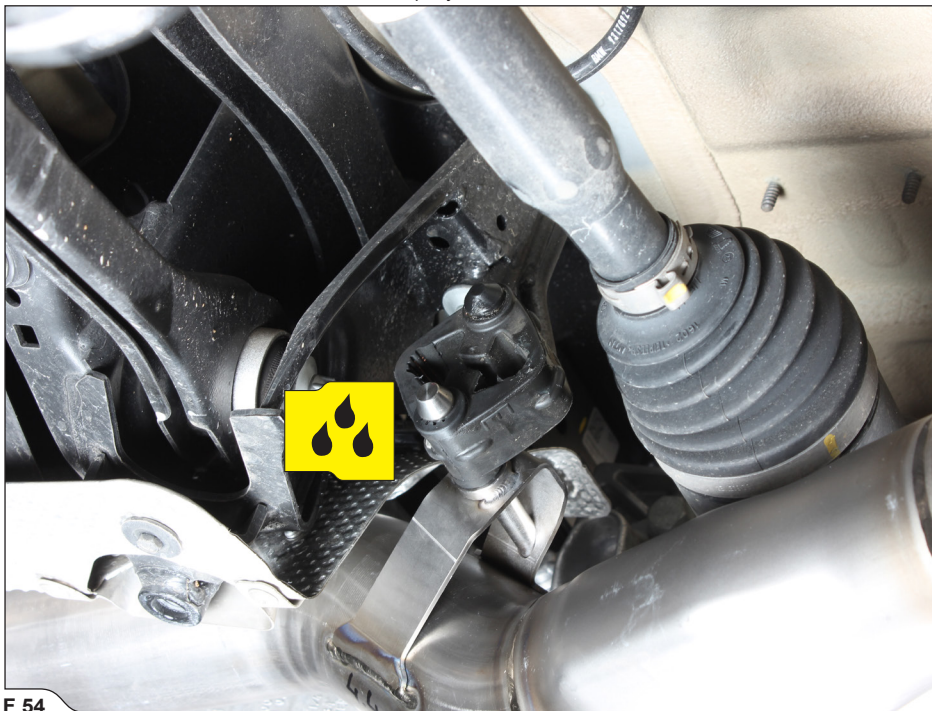

F 54

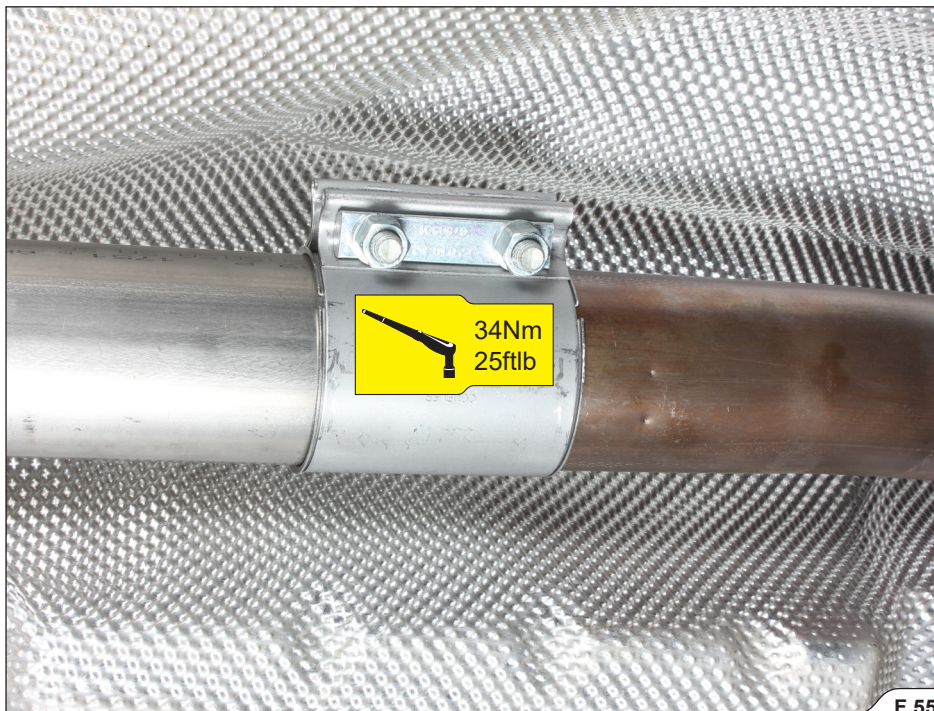

- ! **IMPORTANT:** secure the actuator's wiring harness in such a way, that it won't touch any hot or moving parts of the vehicle - drill the 5mm hole in the heat shield, as shown and secure the harness, using tie wrap from Akrapovič installation kit (F 56).

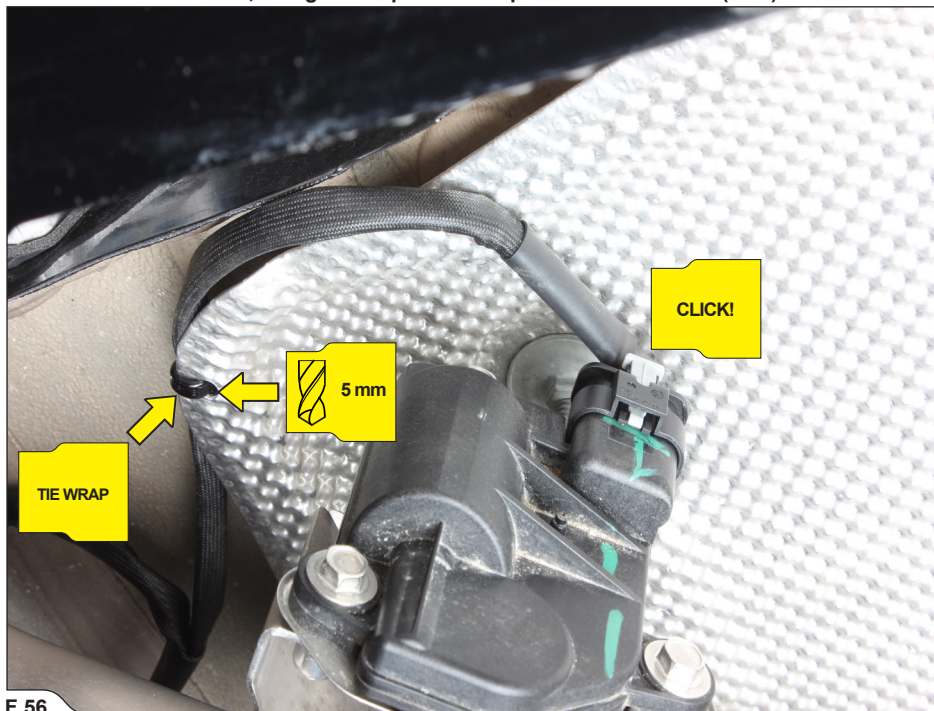

F 56

9. Assemble the tail pipes as shown and slide them onto the muffler outlets (F 57, 58).

! **IMPORTANT:** make sure, not to damage tail pipes, bumper or any part of the vehicle during this process!



10. Rotate and center the tail pipes in respect to bumper's cut-outs and according to your personal preference and tighten the clamps to the specified torque (F 59, 60, 61, 62).

! **IMPORTANT:** we suggest, that the left side, adjustable tail pipe is set on "open" position for a better sound experience (F 59, 60)!

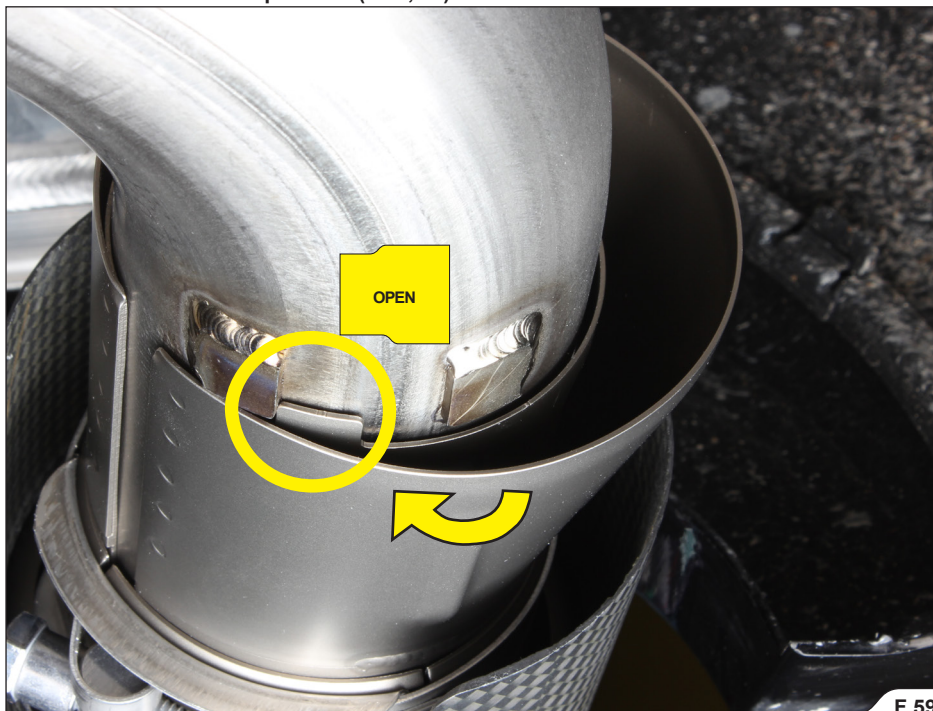

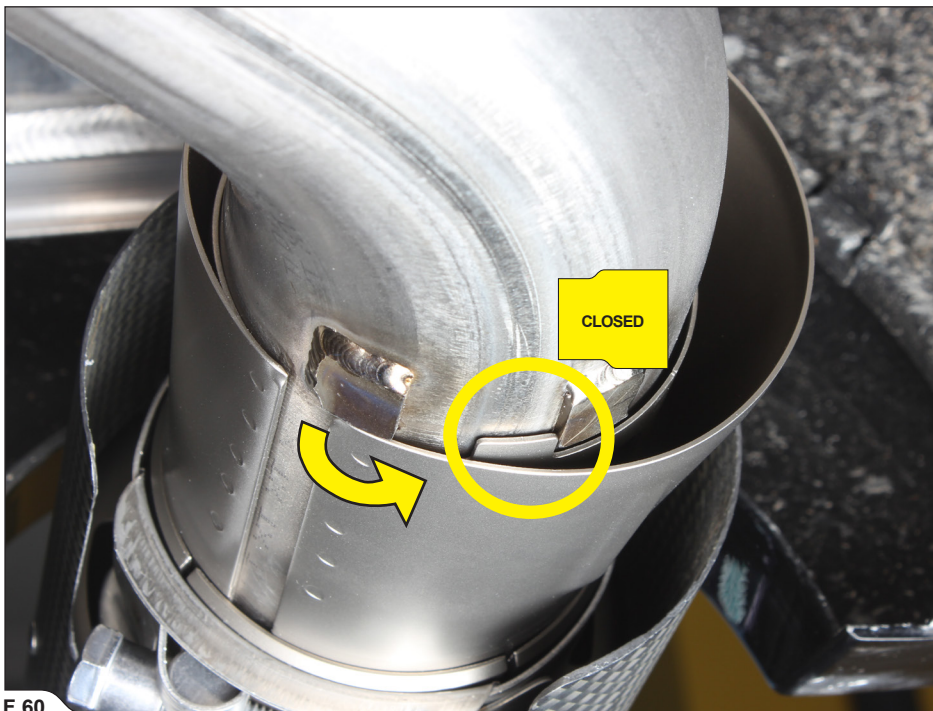

F 60

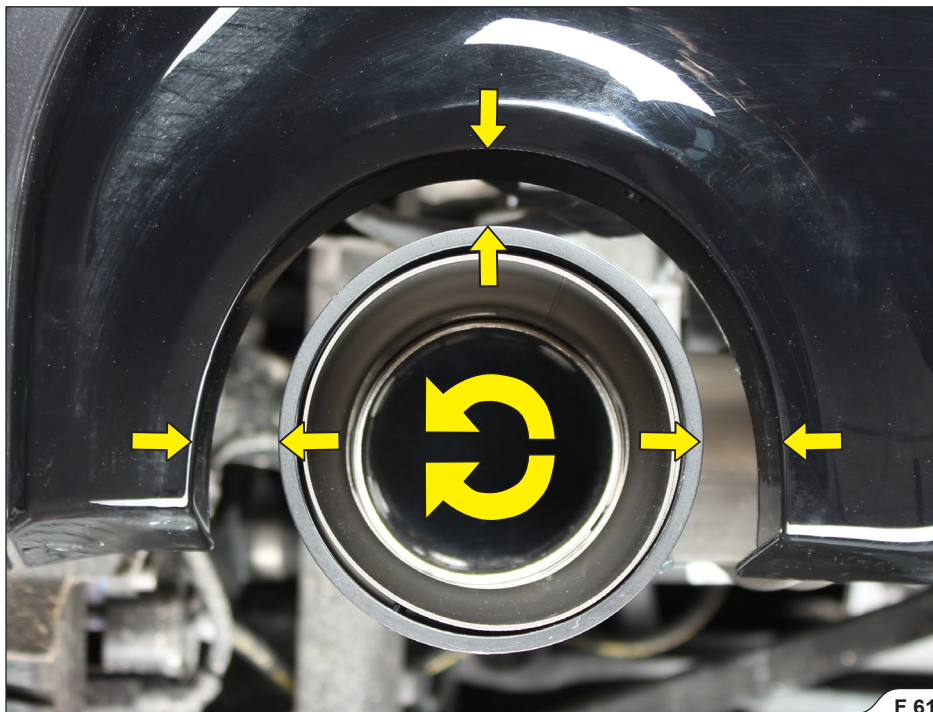

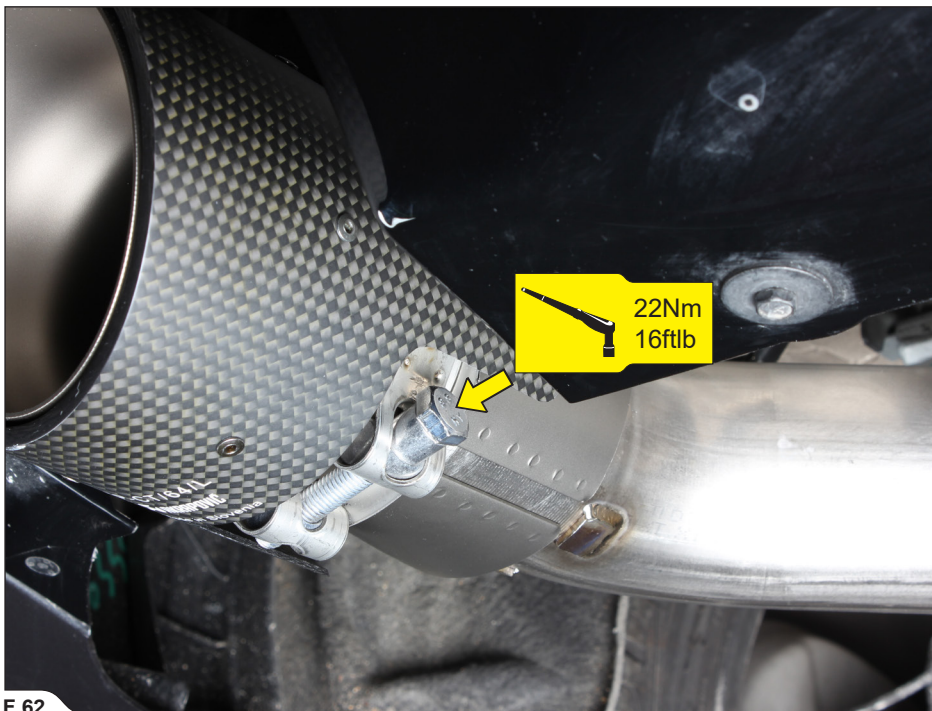

F 62

FINAL INSTALLATION:

- ! **IMPORTANT:** reinstall the dismantled or partially removed stock parts (wheel arches, bumper etc.); check vehicle manufacturer manual for tightening torques.
- ! **IMPORTANT:** make sure all the nuts and bolts are sufficiently tightened. In case the exhaust system touches the cowling or other parts, repeat the adjustment of the exhaust system or contact your authorized dealer.
- ! **IMPORTANT:** clean all exhaust components before the first start of the engine or the stains will burn onto the surfaces!

MAINTENANCE OF THE AKRAPOVIČ EXHAUST SYSTEM:

1. Clean the titanium exhaust components with a multi-purpose spray lubricant (WD-40[®] or equivalent)*, carbon fiber exhaust components with soft and dry cloth and stainless steel components with soft cloth sprayed with contact cleaner, then wipe with soft and dry cloth. A change in the color of the exhaust system is normal due to high temperatures.
2. Periodically make sure all the bolts and springs are sufficiently tight.

*WD-40[®] is a trademark of the WD-40 Company.

 **INSTALLATION TIP: IT IS NORMAL FOR WHITE SMOKE TO COME OUT OF THE MUFFLER AT FIRST OPERATION.**

- ! **CAUTION: DO NOT STAND BEHIND THE MUFFLER AT ANY TIME.**
- ! **CAUTION: DO NOT USE AUTOMOTIVE WHEEL CLEANERS OR ANY CLEANING PRODUCTS WHICH CONTAIN ACIDIC ADDITIVES TO CLEAN THE AKRAPOVIČ EXHAUST SYSTEMS.**

WARNING: THE EXHAUST SYSTEM CAN BE EXTREMELY HOT. ALLOW THE EXHAUST AND ENGINE TO COOL DOWN BEFORE BEGINNING INSTALLATION OR ANY OTHER WORK ON THE EXHAUST SYSTEM. THIS MANUAL IS SPECIFIC TO THE BMW M135i TYPE F40. THERE MAY BE SOME DIFFERENCES IN INSTALLATION PROCEDURES FOR OTHER MODELS.

TROUBLESHOOTING:

Problem	Possible cause	Solution
Exhaust gas leaks out of the muffler/pipe clamp connections	loosened clamp	tighten the clamp to specified torque
	connection is not completely joined	tap the connection into place and tighten the clamp to specified torque
Valves are not moving	No supply	Check green LED on the Controller TNG. If the LED is off: <ul style="list-style-type: none">• Check electrical connection and connectors• Check fuse for exhaust valves
	Error detected	Check green LED on the Controller TNG. If the LED is continuously ON: <ul style="list-style-type: none">• There are no errors detected. If the LED is continuously blinking: <ul style="list-style-type: none">• There is an error detected. Connect the Controller TNG to PC via micro USB cable and use Akrapovic tools diagnostic utility, that can be found at http://www.akrapovic.com

DECLARATION OF CONFORMITY OF CONTROLLER TNG

COMPANY: Akrapovič d.d.
ADDRESS: Malo Hudo 8a
1295 Ivančna Gorica, Slovenia

declares that the following products:

Product name: Controller TNG
Trade Name: Akrapovič
Type or model: P-AE100

is in conformity with the requirements of the following Directives of the European Union:
Regulation UN/ECE-R10 rev6



10R -06 1323

FCC NOTICE

This device complies with part 15 of the FCC rules. Operation is subject to the following two conditions: **(1)** This device may not cause harmful interference, and **(2)** this device must accept any interference received, including interference that may cause undesired operation.

Changes or modifications not expressly approved by the party responsible for compliance could void the user's authority to operate the equipment.

You can view your product's FCC Declaration of Conformity (DoC) to the FCC 47 CFR Part 15, SubpartB, at: <http://www.akrapovic.com/docs/ControllerTNG/FCCCertification.pdf>.

European Union Directives Conformance Statement

CE Akrapovič d.d. hereby declares that this Akrapovič Controller TNG P-AE100 is in compliance with the essential requirements and other relevant provisions of Directive 2014/30/EU

You can view your product's Declaration of Conformity (DoC) to Directive 2014/30/EU (to EMC Directive) at: <http://www.akrapovic.com/docs/ControllerTNG/CECertification.pdf>.

DECLARATION OF CONFORMITY

COMPANY: Atlan d.o.o.
ADDRESS: Sveti Anton, Hrib 9
6276 Pobegi, Slovenia

declares that the following products:

Product name: Communication Detector
Trade Name: Atlan
Type or model: VTS CAN SNIFFER

is in conformity with the requirements of the following Directives of the European Union:
Regulation UN/ECE-R10 rev5



10 R - 05 1141

FCC NOTICE

This device complies with part 15 of the FCC rules. Operation is subject to the following two conditions: **(1)** This device may not cause harmful interference, and **(2)** this device must accept any interference received, including interference that may cause undesired operation.

Changes or modifications not expressly approved by the party responsible for compliance could void the user's authority to operate the equipment.

You can view your product's FCC Declaration of Conformity (DoC) to the FCC 47 CFR Part 15, SubpartB, at <http://www.akrapovic.com/docs/CanSniffer/FCCCertification.pdf>.

Industry Canada compliance statement

This Class B digital apparatus complies with Canadian ICES-003. This device complies with Industry Canada licence-exempt RSS standard(s). Operation is subject to the following two conditions:

(1) this device may not cause interference, and **(2)** this device must accept any interference, including interference that may cause undesired operation of the device.

Cet appareil numérique de la classe B est conforme à la norme NMB-003 du Canada. Le présent appareil est conforme aux CNR d'Industrie Canada applicables aux appareils radio exempts de licence. L'exploitation est autorisée aux deux conditions suivantes :

(1) l'appareil ne doit pas produire de brouillage, et **(2)** l'utilisateur de l'appareil doit accepter tout brouillage radioélectrique subi, même si le brouillage est susceptible d'en compromettre le fonctionnement.

European Union Directives Conformance Statement

CE Atlan d.o.o. hereby declares that this Atlan Communication Detector VTS CAN SNIFFER is in compliance with the essential requirements and other relevant provisions of Directive 2004/108/EU

You can view your product's Declaration of Conformity (DoC) to Directive 2004/108/EU (to EMC Directive) at <http://www.akrapovic.com/docs/CanSniffer/CECertification.pdf>.

www.akrapovic.com

