



## Installation instructions

Akrapovič Exhaust System:  
**Evolution**  
for the  
**VW GOLF GTI** (type MK VII.)





## Installation instructions

Akrapovič Exhaust System:  
**Evolution**  
for the  
**VW GOLF GTI** (type MK VII.)

**Congratulations on purchasing an Akrapovič exhaust system. Please read the entire installation manual prior to undertaking any activities related to installation of your new Akrapovič exhaust system. In case you do not fully understand the manual or any of its parts, please contact your authorized dealer!**

**This product should be installed by someone with sufficient knowledge of exhaust systems and their installation, and appropriate hand or power tools. If you are not qualified for this work, please utilize a certified mechanic for installation. By installing Your Akrapovič exhaust system, you indicate that you have read the installation manual in its entirety and you agree with the terms stated herein.**

**It is your responsibility to follow all installation instruction guidelines supplied with the Akrapovič exhaust system and undertake all necessary safety precautions. Akrapovič d.d. assumes no responsibility for damages occurring from misuse, abuse, improper installation, improper operation, lack of responsible care, or all previously stated reasons resulting from incompatibility with other manufacturer's products and/or systems.**

## **IMPORTANT INFORMATION**

### **Exclusion of Certain Liability**

1. The manufacturer, importer or dealer shall not be liable for any incidental damage including personal injury or any other damages caused by improper installation or operation of the Akrapovič exhaust system. When installing the Akrapovič exhaust system be careful that the exhaust system does not touch other parts sensitive to high temperature.
2. Akrapovič makes no representation or warranties with regard to damage caused by the improper installation, use and maintenance of the Akrapovič exhaust system. The warranty is limited to defects recognized by our technical department and due to normal use, and excludes items subject to normal wear (gaskets and damping wool). The guarantee is void in case of accident, modification, improper or competition use.
3. Do not attempt to install the Akrapovič exhaust system on a vehicle model for which it was not made or tested by Akrapovič.
4. When the exhaust system gets very hot during operation, be careful not to burn yourself on the exhaust system or parts which are in direct contact with it, even when the engine is not running. Also protect other people, especially children, from the injuries mentioned above.

1. In some cases Akrapovič exhaust system kits contain chemical products (ceramic anti-seizing grease; bolt sealant). Handle with care, do not inhale or swallow. Avoid excessive contact with skin, eyes or mucous membranes. Keep out of reach of children.
2. Technical specifications of Akrapovič exhaust systems and related products are subject to change without notice.
3. Before removing the original exhaust system from your vehicle, please compare the parts you received with the list of materials provided in the installation manual in order to assure that you have all the parts necessary for the installation of your new Akrapovič exhaust system.
4. Although this manual consists of instructions for installation in written form, as well as photographs and pictures representing individual steps of the installation, please note that the photographs and pictures are symbolic and are intended for representation of general overview only. The photographs and pictures contained herein should serve as a guideline only and actual installation of the exhaust system may not correspond with the photographs and pictures entirely.
5. The process of uninstalling the original exhaust system may vary depending on the existing exhaust system. Please follow the original exhaust system manufacturer's instructions for uninstalling the original exhaust system.

### **Trademarks**

The Akrapovič Exhaust System Technology logo is a registered trademark of Akrapovič d.d.

### **Akrapovič website**

Information about Akrapovič exhaust systems and related products is available on the Akrapovič website at:

**<http://www.akrapovic.com/>**

### **Copyright**

No part of the Akrapovič exhaust system or its documentation may be reproduced or distributed in any form or by any means without the prior written authorization of the Akrapovič company.

© Akrapovič, d.d. All rights reserved.

## Symbols

The following symbols are used throughout these installation instructions:



**TOOLS REQUIRED**



**TIGHTENING TORQUE**



**INSTALLATION TIP**



**CAUTION OR WARNING**



**USE BOLT SEALANT;** Apply 3 to 4 small drops of bolt sealant onto the cleaned and degreased threads before tightening the bolts. **WARNING! Avoid contact with skin, eyes and mucous membranes. Do not inhale fumes. Keep out of the reach of children.**



**USE ANTI-SEIZE LEAD-FREE COPPER PASTE** (black tube); Provides trouble-free and long-lasting protection against seizing, corrosion and rusting of bolts, threaded ends, nuts, joints, etc. Also protects against vibration, wear and impact. **WARNING! Avoid eye contact. Avoid excessive skin contact. Keep out of reach of children.**



**USE ANTI-SEIZING GREASE** (white tube); Prevents seizing, corrosion and excessive wear between the titanium components of your exhaust system. **WARNING! Avoid eye contact. Avoid excessive skin contact. Keep out of reach of children.**



Combination 22 mm wrench  
Torx 30  
T-handle swivelling 13 mm wrench  
Bi-hex 15 mm socket  
Pry bar



**BEFORE INSTALLING, CHECK SCHEMATIC OF THE EXHAUST SYSTEM! THE LATEST VERSION OF THE PARTS LIST AND SCHEMATIC DRAWINGS OF THE PRODUCTS ARE AVAILABLE ON OUR WEB PAGE.**



**IF ANY ITEMS IN THE AKRAPOVIČ EXHAUST SYSTEM PACKAGE ARE MISSING, PLEASE CONTACT YOUR AUTHORIZED DEALER. KEEP THE SCHEMATIC FOR FUTURE REFERENCE.**



**THESE INSTALLATION INSTRUCTIONS MUST BE READ CAREFULLY IN ORDER TO ENSURE PROPER INSTALLATION AND OPERATION OF THE AKRAPOVIČ EXHAUST SYSTEM.**



**THE EXHAUST SYSTEM CAN BE EXTREMELY HOT. ALLOW THE EXHAUST AND ENGINE TO COOL DOWN BEFORE BEGINNING INSTALLATION.**



**WE ADVISE YOU TO LEAVE INSTALLATION TO A QUALIFIED SERVICEMAN. IMPROPER INSTALLATION MAY RESULT IN A SHORTER LIFETIME OF THE EXHAUST SYSTEM AND/OR DAMAGE TO THE VEHICLE.**



**THIS MANUAL IS SPECIFIC TO THE VW GOLF GTI. THERE MAY BE SOME DIFFERENCES IN INSTALLATION PROCEDURES FOR OTHER GTI MODELS.**



**WHEN INSTALLING AKRAPOVIČ'S AFTERMARKET OPTIONAL DOWN PIPES WITHOUT CATALYTIC CONVERTERS, WHICH ARE DEVELOPED FOR USE ON CLOSED TRACKS ONLY, REMAPPING OF THE ECU IS MANDATORY. THE AKRAPOVIČ COMPANY TAKES NO RESPONSIBILITY FOR ECU REMAPPING OR ANY POTENTIAL ISSUES RELATED TO THE USE OF AKRAPOVIČ DOWN PIPES.**

## **REMOVAL OF STOCK EXHAUST SYSTEM:**

Put the vehicle onto a car lift.

**WARNING:** make sure, that car lifting is safely and correctly done or you risk vehicle damage, injury or even death!

1. Unscrew the rear chassis reinforcement and slide the rubber bracket off the pipe (Figure 1).

**! INSTALLATION TIP:** for easier dismounting, lubricate the rubber bracket (WD40).

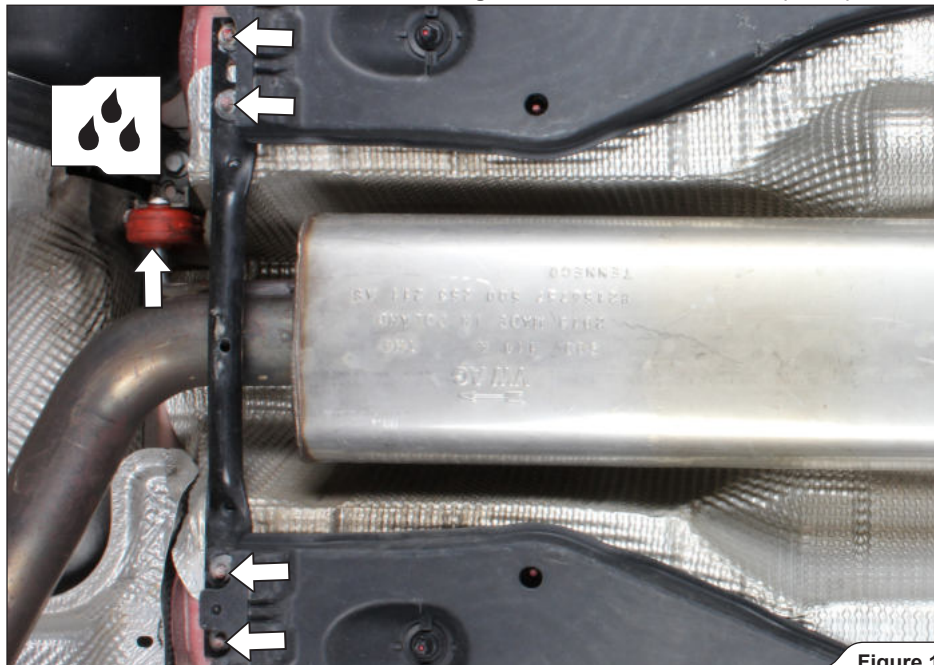

Figure 1



2. Unscrew the front chassis reinforcement and loosen the double clamp (**Figure 2**).

! **CAUTION:** make sure not to injure yourself or damage any part of the vehicle during this process!

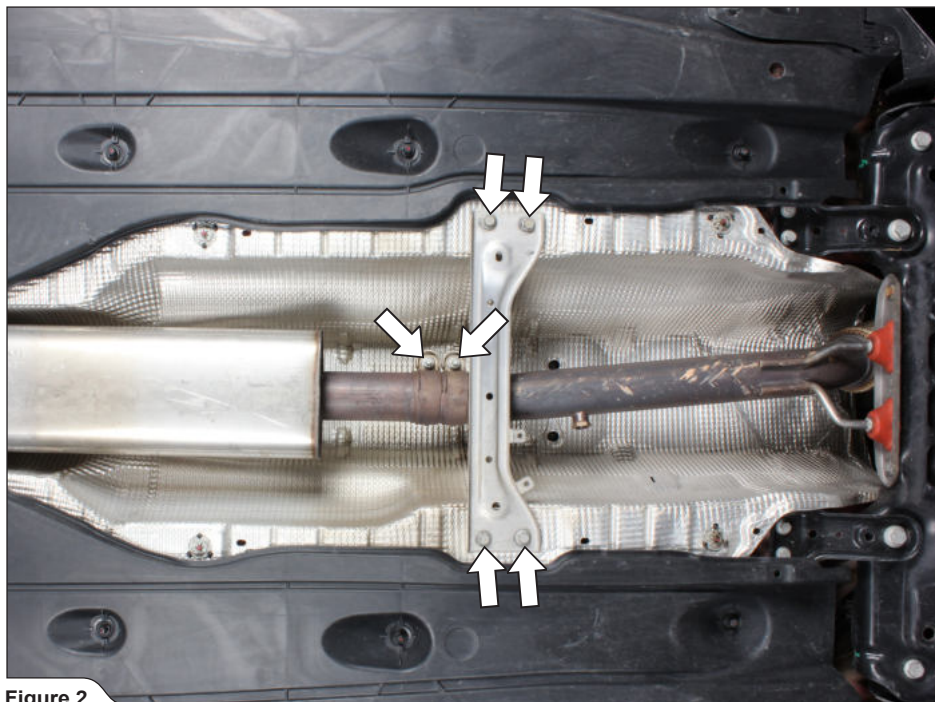

Figure 2

3. Unscrew the rubber bracket on both sides of the muffler and carefully remove the stock exhaust system off the vehicle (**Figure 3**).

! **WARNING:** make sure, that you support the exhaust system during this process or you could injure yourself or damage the vehicle!

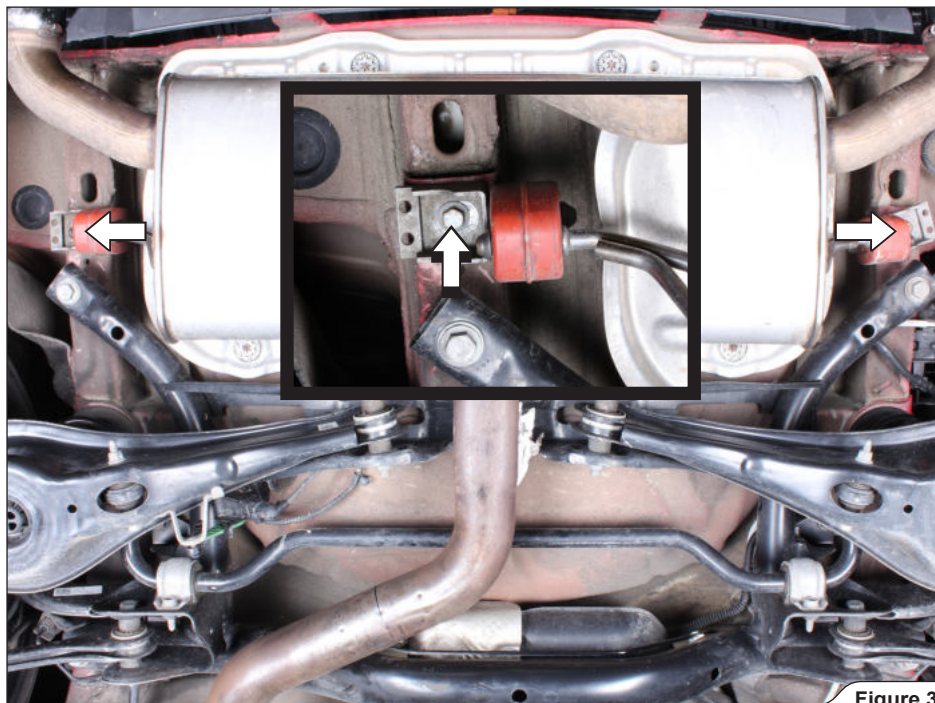
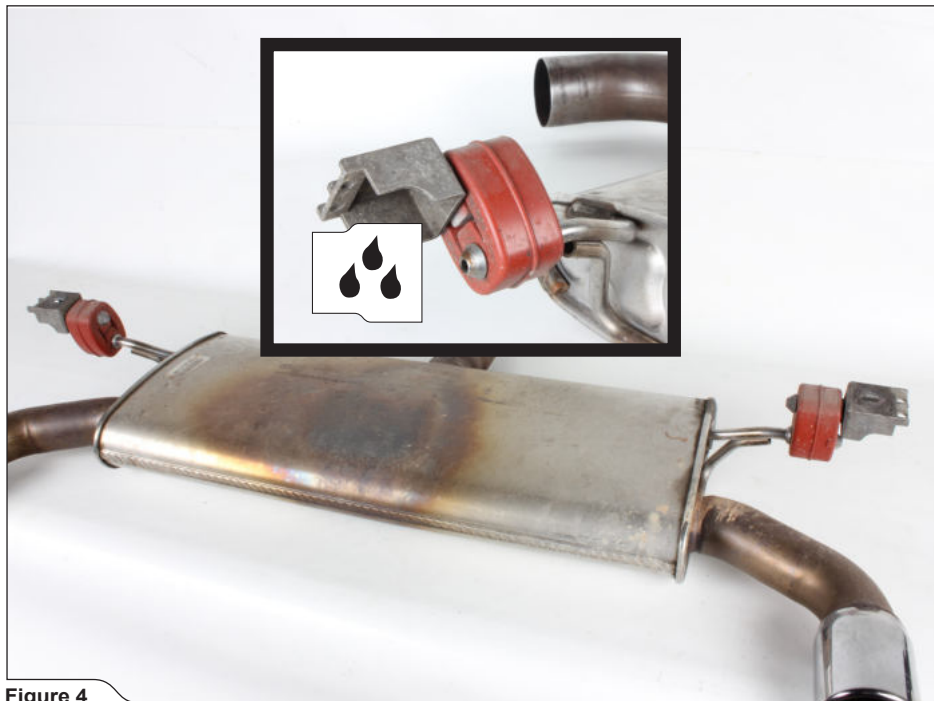

Figure 3

4. Carefully remove the rubber brackets off the muffler brackets (**Figure 4**).

**✂** **INSTALLATION TIP:** for easier dismounting, lubricate the rubber brackets (WD40).



**Figure 4**

5. Unscrew the marked bolts and remove the bracket off the stock down pipe (**Figure 5**).

**✂** **INSTALLATION TIP:** for easier dismounting, lubricate the rubber brackets (WD40).

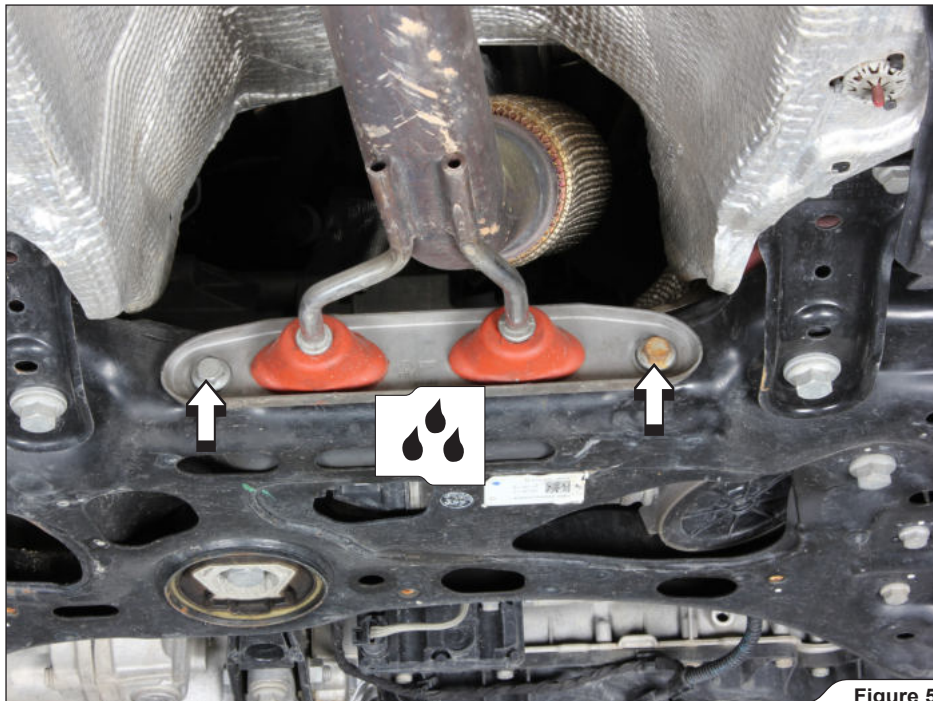

Figure 5

6. Unscrew the marked clamp in the engine compartment (**Figure 6**).

**!** **CAUTION:** make sure not to injure yourself or damage any part of the vehicle during this process!

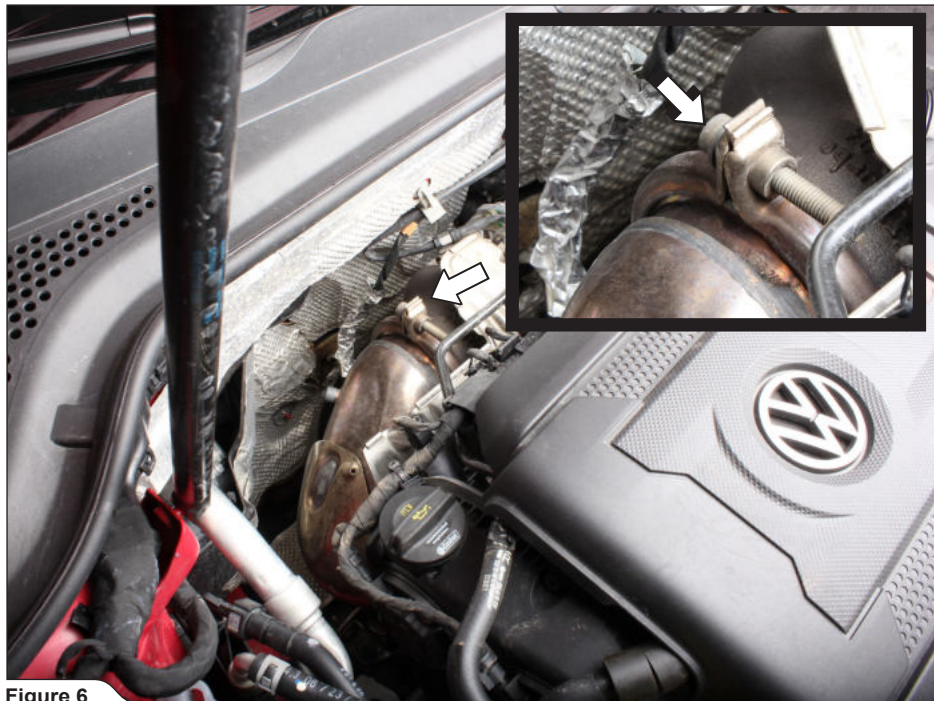

Figure 6

7. Carefully unscrew the lambda sensor out of the down pipe (**Figure 7**).

**!** **WARNING:** be careful not to damage the sensor's wiring harness or the lambda sensor during this process!



**Figure 7**

8. Unscrew the two down pipe's bracket nuts (Figure 8).

! **CAUTION:** make sure not to injure yourself or damage any part of the vehicle during this process!

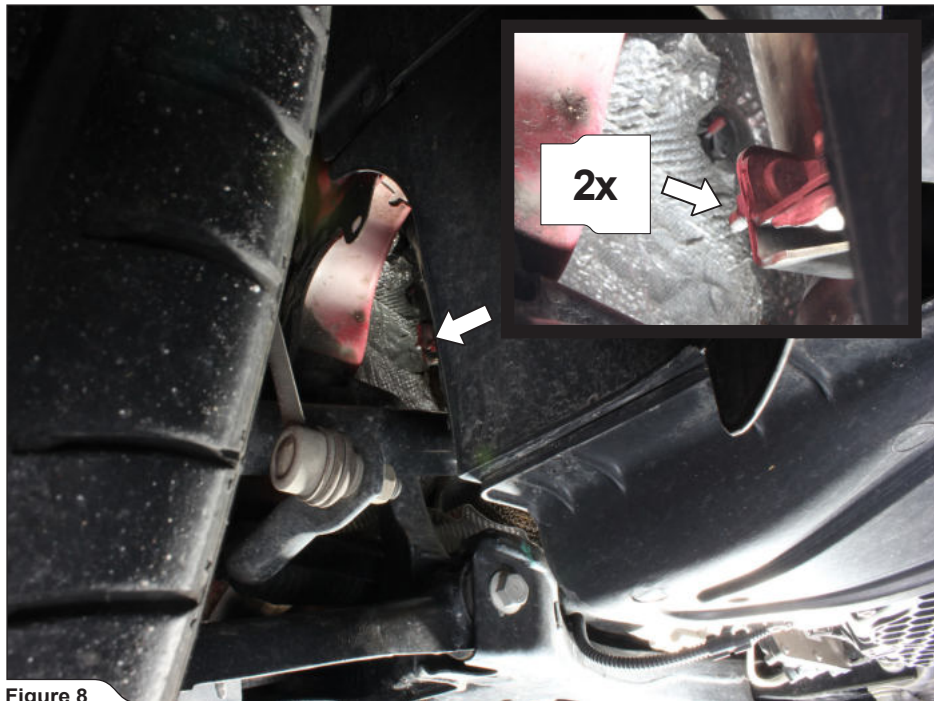

Figure 8

9. Unscrew the four heat protection's bolts, carefully remove the heat protection and the down pipe off the vehicle (**Figure 9**).

! **CAUTION:** make sure not to injure yourself or damage any part of the vehicle during this process!

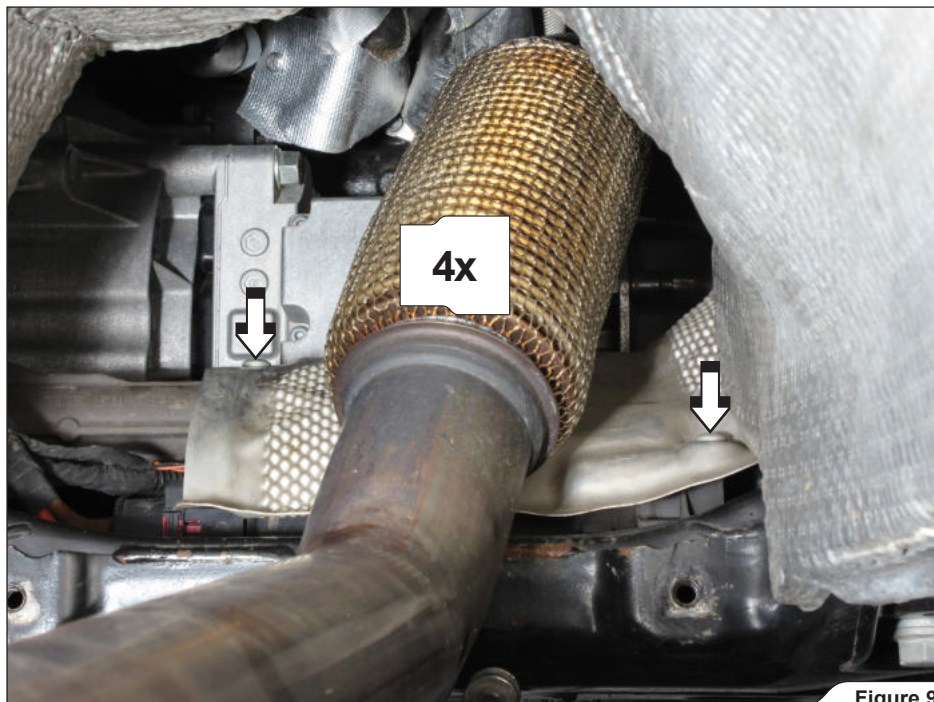

Figure 9



## **INSTALLATION OF THE AKRAPOVIČ EXHAUST SYSTEM:**

1. Insert the Akrapovič Down Pipe into the engine compartment and reinstall the stock heat protection (Figure 10).

**!** CAUTION: make sure not to injure yourself or damage any part of the vehicle during this process!

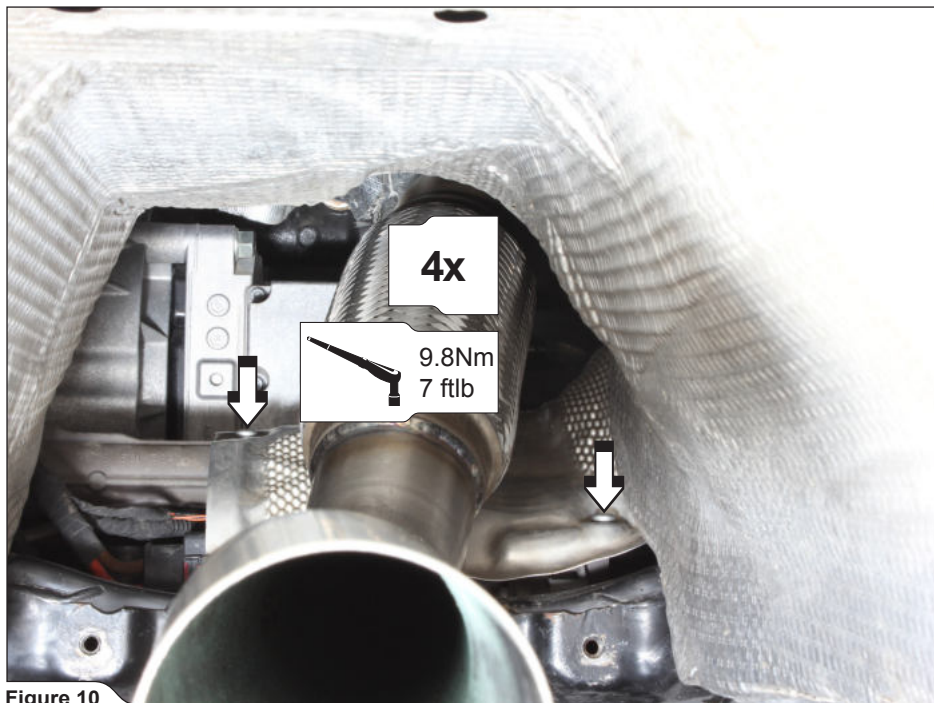

Figure 10

2. Install the lambda sensor and tighten the Down Pipe's bracket, using stock nuts (**Figure 11**).

! **WARNING:** be careful not to damage the sensor's wiring harness or the lambda sensor during this process!

! **CAUTION:** make sure not to injure yourself or damage any part of the vehicle during this process!

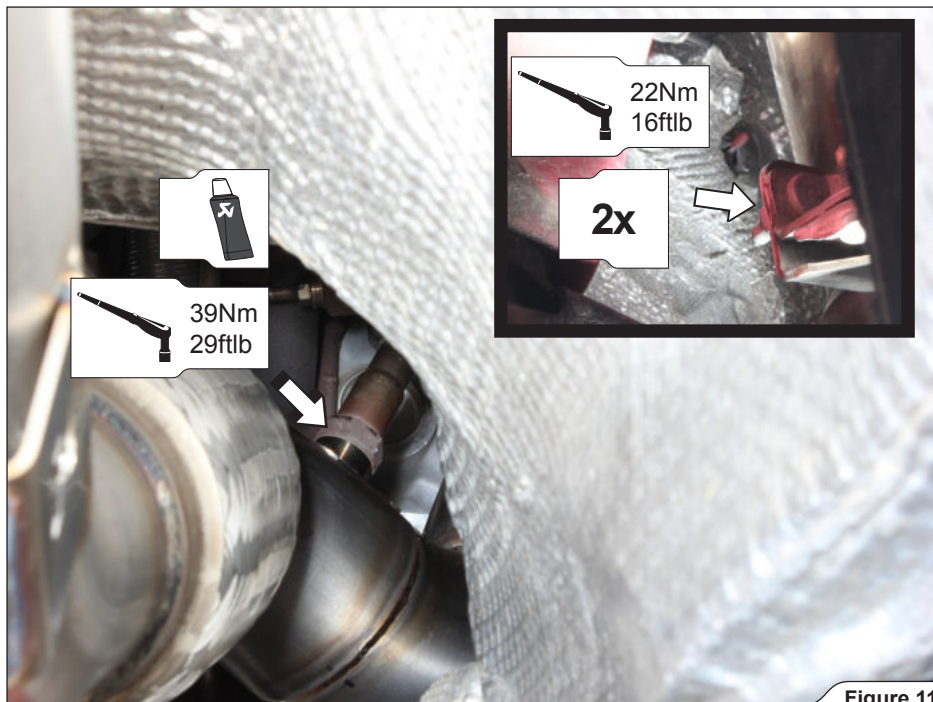

Figure 11

3. Attach the stock bracket onto the Akrapovič Down Pipe and tighten the bracket onto the chassis, using stock bolts (**Figure 12**).

**AK** **INSTALLATION TIP:** for easier mounting, lubricate the original rubber brackets (WD40).

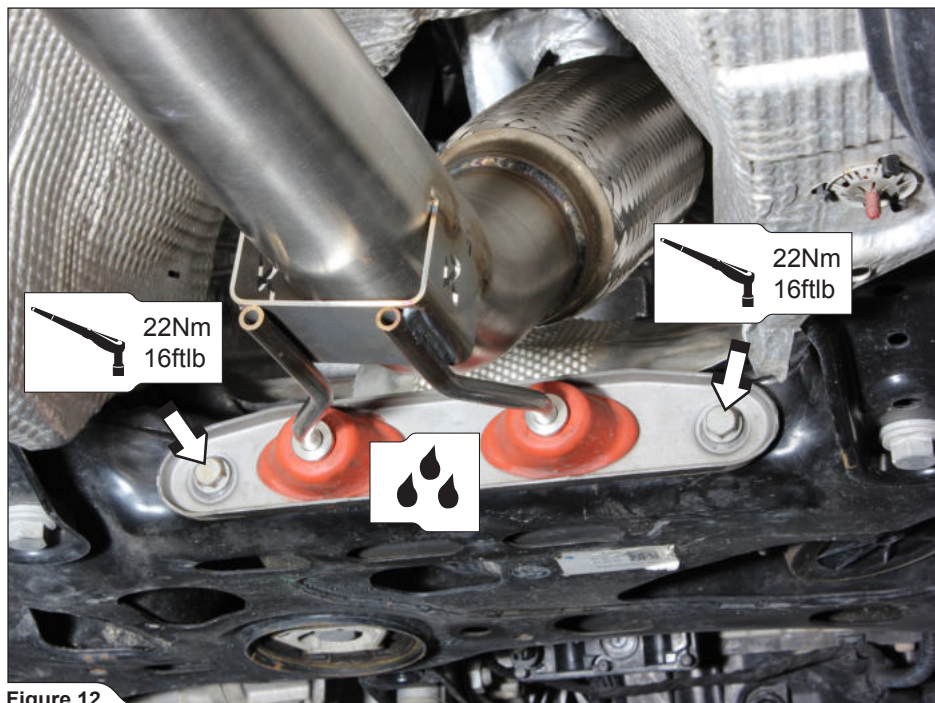

Figure 12

4. Attach the Down Pipe to the turbo charger, using stock clamp (**Figure 13**).

**!** CAUTION: we advise to use new stock exhaust gasket in this joint!

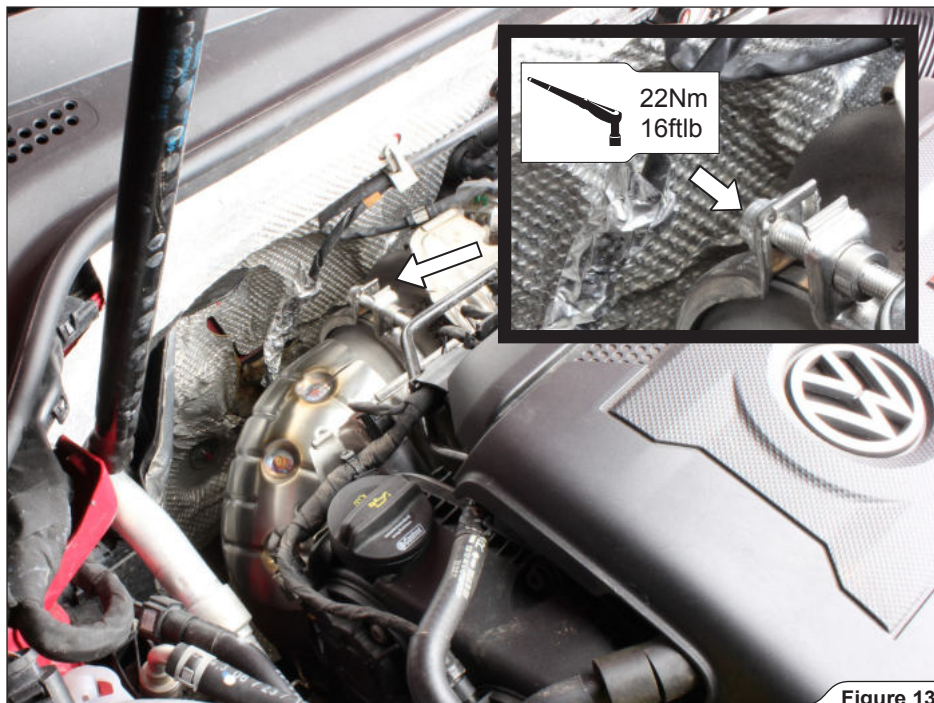

Figure 13

5. Correctly orient and slide the clamp from installation kit onto the link pipe (**Figure 14**).

! **WARNING:** use anti-seize copper paste on clamp's bolt and nut threads!

! **CAUTION:** hand tighten the clamp only!

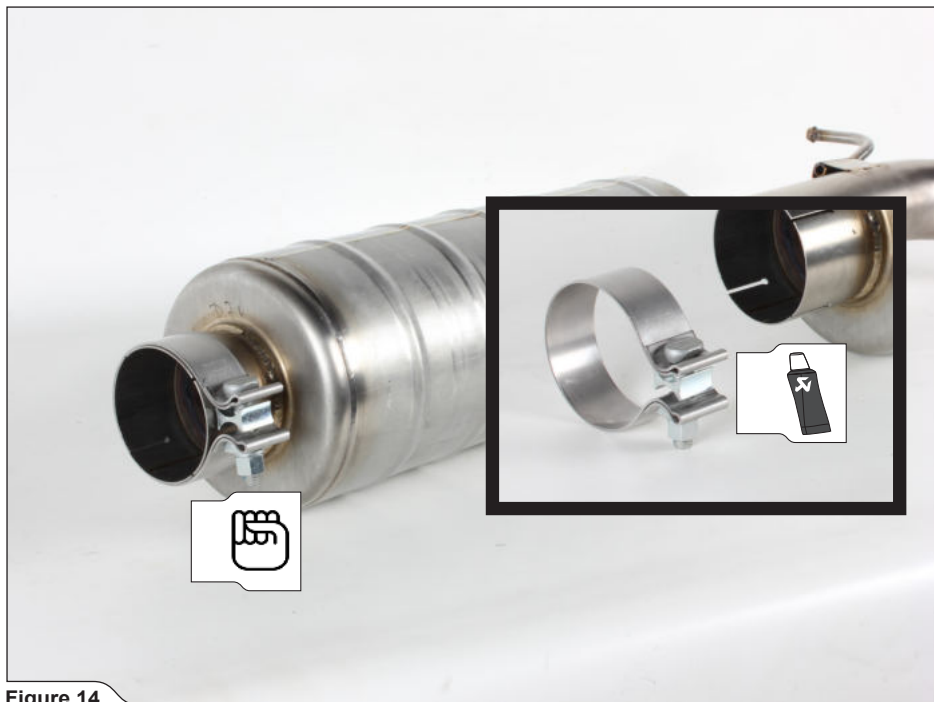

Figure 14

- Slide the Link Pipe all the way onto the Down Pipe's outlet, attach the Link Pipe's bracket to the stock rubber bracket, hand tighten the clamp and reinstall the two reinforcements back onto the chassis (Figure 15, 16).

! **CAUTION:** make sure not to injure yourself or damage any part of the vehicle during this process!

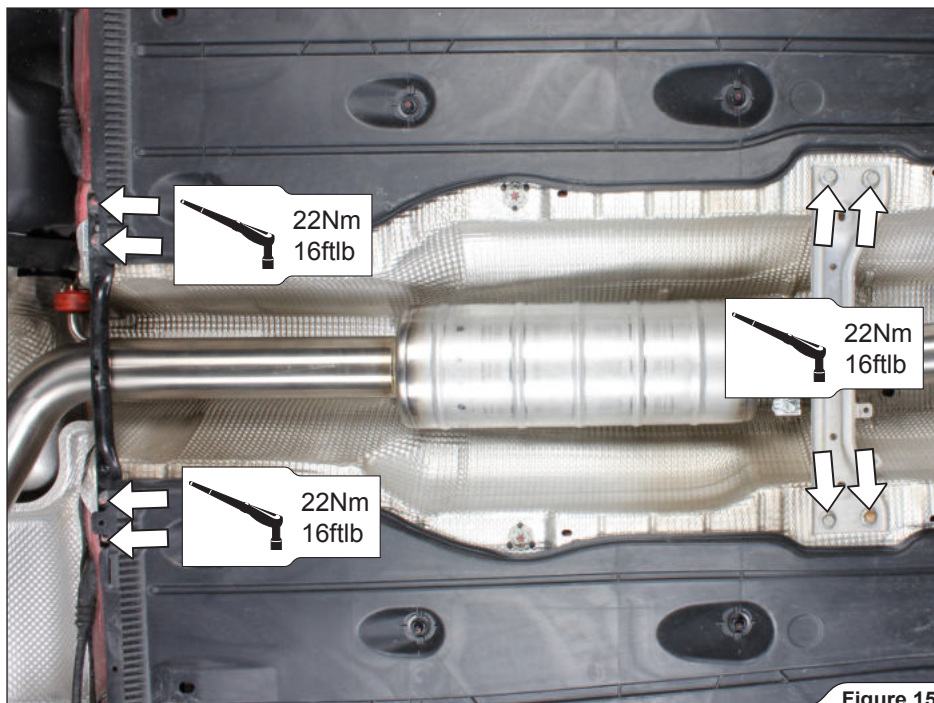



Figure 15

 **INSTALLATION TIP:** for easier mounting, lubricate the original rubber brackets (WD40).

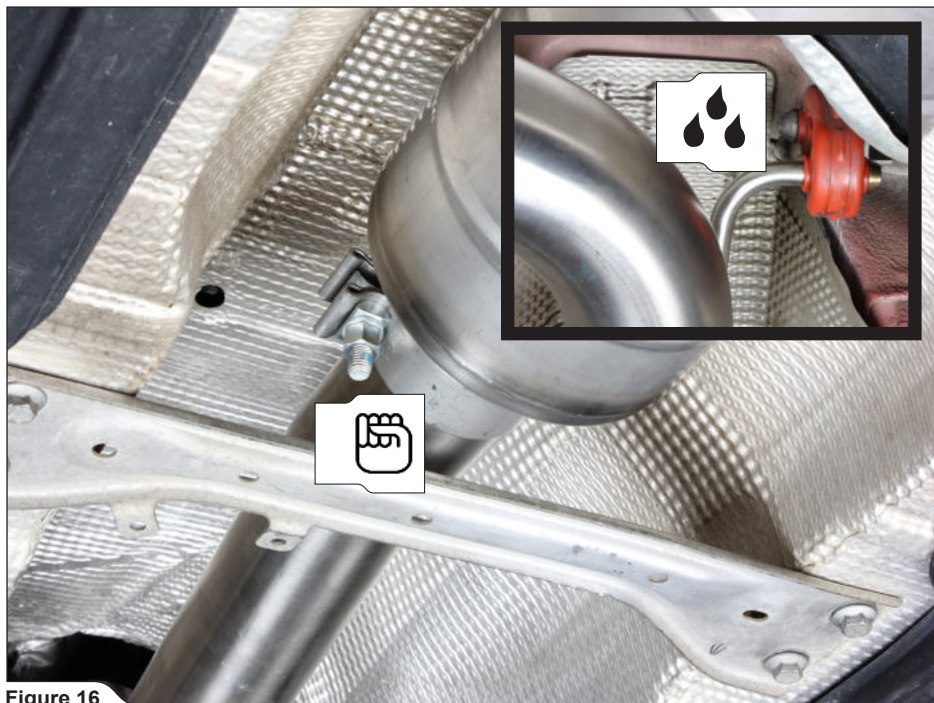

Figure 16

7. Attach the stock rubber brackets onto the Akrapovič muffler, as shown (Figure 17).

**✂ INSTALLATION TIP:** for easier mounting, lubricate the stock rubber brackets (WD40).

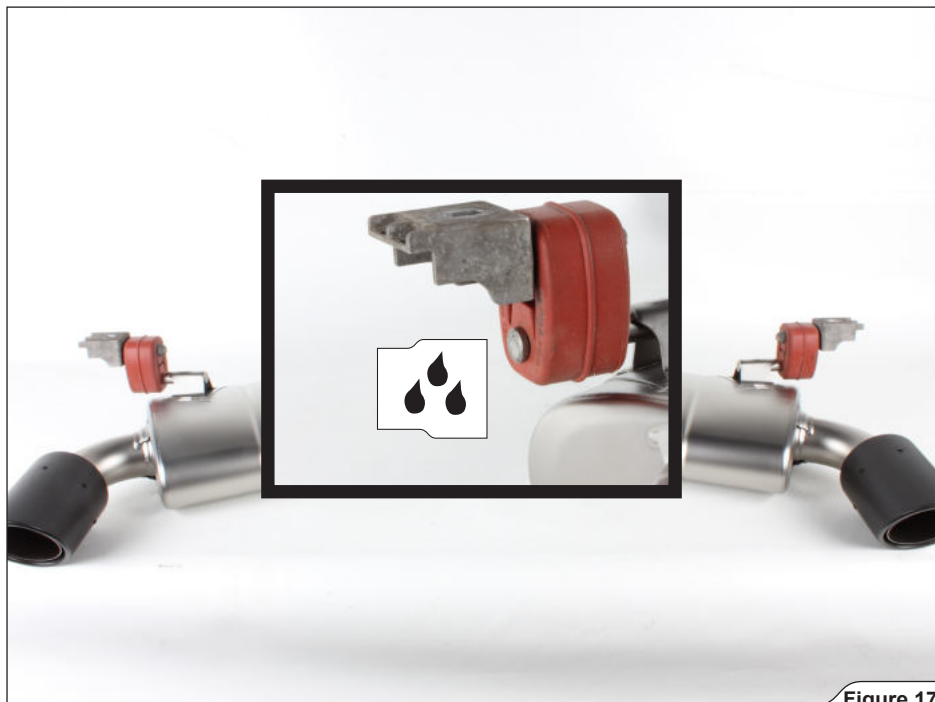

Figure 17



8. Correctly orient and slide the double clamp from installation kit onto the muffler's inlet pipe (Figure 18).

! **WARNING:** use anti-seize copper paste on all clamp's bolt and nut threads!

! **CAUTION:** hand tighten the clamp only!

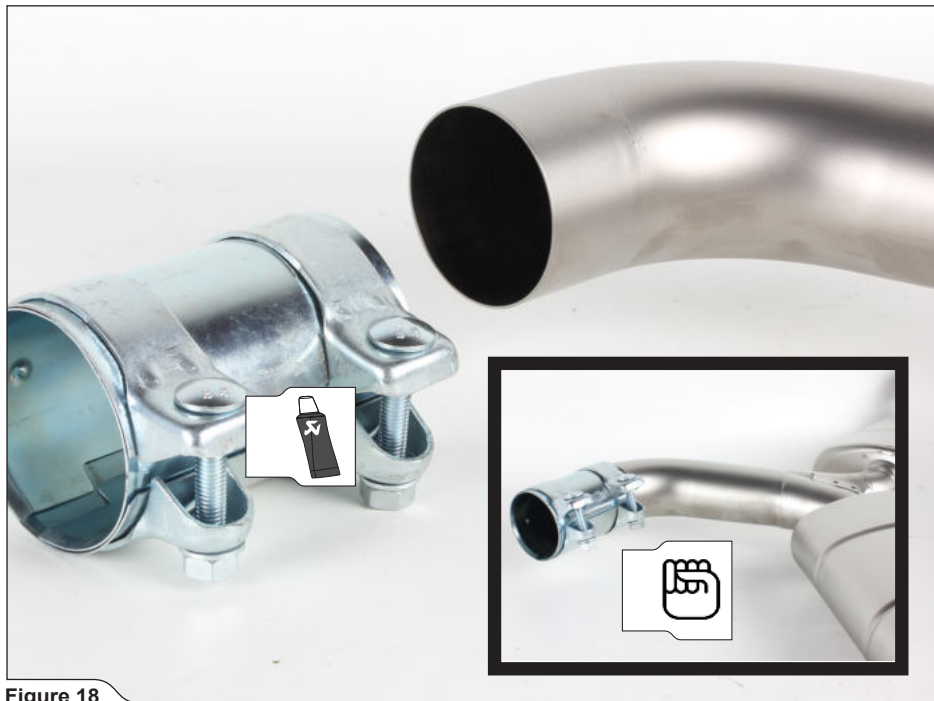

Figure 18

- Slide the muffler onto the Link Pipe and tighten the stock muffler's rubber brackets onto the vehicle chassis (**Figure 19**).

**!** **WARNING:** make sure, not to injure yourself or damage any part of the vehicle during this process!

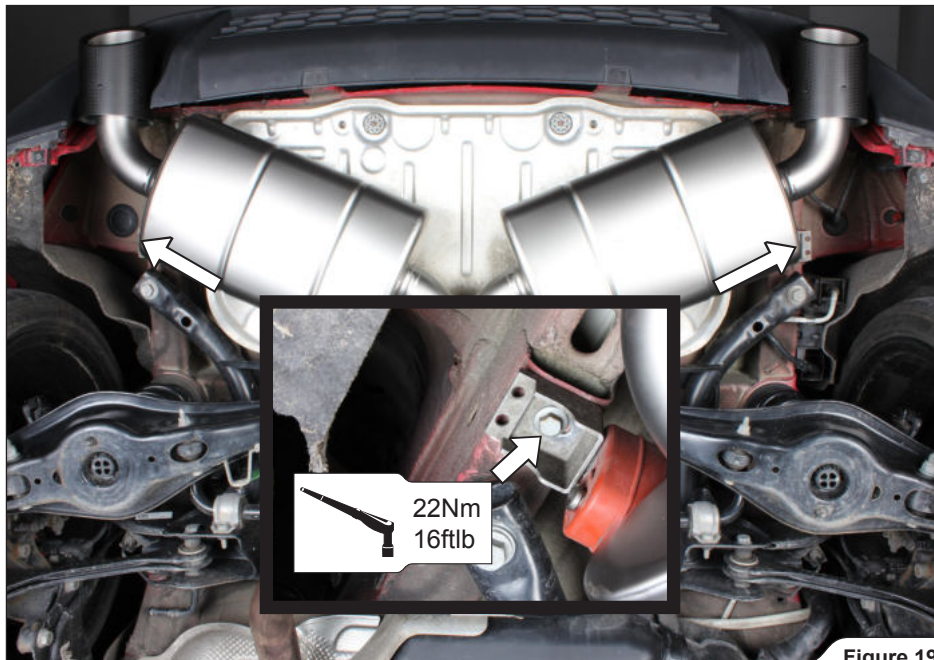

Figure 19

10. Adjust the muffler in respect to the rear bumper and chassis. Center the double clamp on the middle of the joint and tighten it to the specified torque (**Figure 20, 21, 22**).

**!** CAUTION: before tightening of the clamps, make sure, that the marked clearances are sufficient!



Figure 20

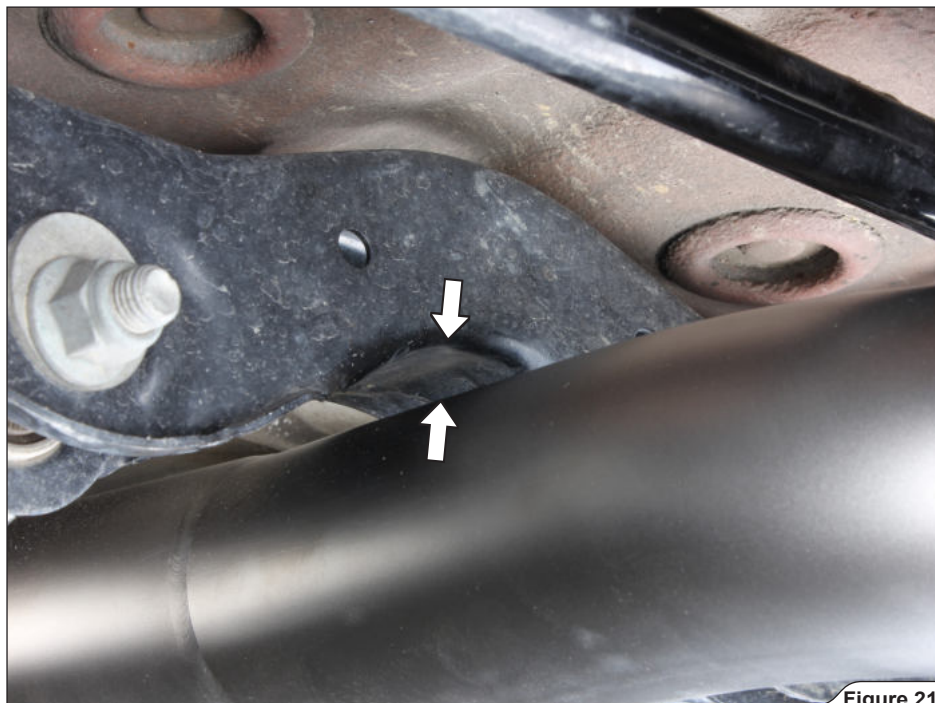

Figure 21

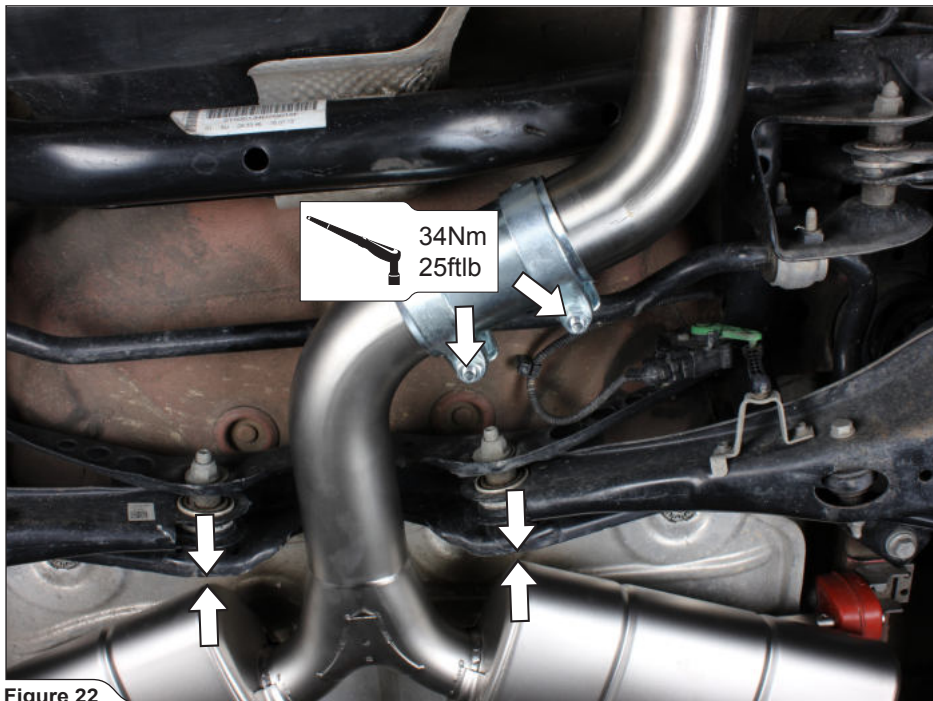
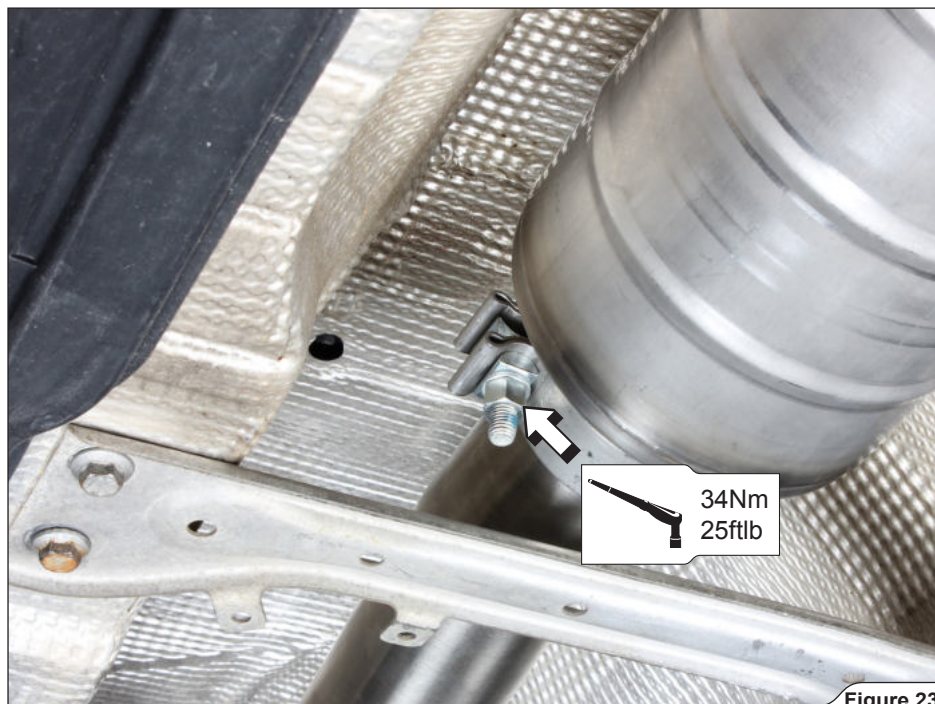

Figure 22

11. Tighten the clamp at the Link Pipe - Down Pipe joint to the specified torque (**Figure 23**).

**!** **CAUTION:** before tightening of the clamp, make sure, that joint is completely merged!



**Figure 23**



## Final installation:

- ! **WARNING: check vehicle manufacturer manual for tightening torques (for dismantled stock parts)!**
- ! **WARNING: make sure all the nuts and bolts are sufficiently tightened. In case the exhaust system touches the cowling or other parts, repeat the adjustment of the exhaust system or contact your authorized dealer.**

## **MAINTENANCE OF THE AKRAPOVIČ EXHAUST SYSTEM**

1. Clean the titanium exhaust components with a multi-purpose spray lubricant (WD-40 or equivalent), carbon fiber exhaust components with soft and dry cloth and stainless steel components with soft cloth sprayed with contact cleaner, then wipe with soft and dry cloth. A change in the color of the exhaust system is normal due to high temperatures.
2. Periodically make sure all the bolts and springs are sufficiently tight.

- ! **WARNING: clean all exhaust components before the first start of the engine or the stains will burn onto the surfaces!**
- ! **IT IS NORMAL IF WHITE SMOKE COMES OUT OF THE MUFFLER ON FIRST OPERATION.**
- ! **DO NOT STAND BEHIND THE MUFFLER ON FIRST OPERATION.**
- ! **DO NOT USE AUTOMOTIVE WHEEL CLEANERS OR ANY CLEANING PRODUCTS WHICH CONTAIN ACIDIC ADDITIVES TO CLEAN AKRAPOVIČ EXHAUST SYSTEMS.**



## **WARNING**

Please note that certain aftermarket exhaust systems may not comply with applicable California laws and regulations, and may therefore be prohibited for use on California highways or roads, or on roads or vehicles otherwise subject to emissions control requirements.

Akrapovič exhaust systems for automobiles and motorcycles mounted downstream of the catalytic converter (also known as “cat-back systems”) are considered “replacement parts” in California by the California Air Resources Board (CARB), and do not require an exemption or executive order from CARB to be sold in California. However, California prohibits the use of any aftermarket exhaust system that modifies, removes or replaces original equipment catalysts, unless CARB has issued an Executive Order as to such part or system.

Further, Akrapovič parts or exhaust systems used or intended for use on “racing vehicles” (i.e. a competition vehicle used exclusively for competition on closed-course circuits) do not require an exemption or Executive Order from CARB to be sold in California. However, such parts are prohibited from use on California public highways or roads, even if occasionally used “off-road.”





[www.akrapovic.com](http://www.akrapovic.com)

