



## Installation instructions

Akrapovič Exhaust Systems:  
**Slip-On, Evolution and optional Down Pipes**  
for the  
**BMW 1 Series M Coupe** (type E82)

## **WARNING**

Please note that certain aftermarket exhaust systems may not comply with applicable California laws and regulations, and may therefore be prohibited for use on California highways or roads, or on roads or vehicles otherwise subject to emissions control requirements.

Akrapovič exhaust systems for automobiles and motorcycles mounted downstream of the catalytic converter (also known as “cat-back systems”) are considered “replacement parts” in California by the California Air Resources Board (CARB), and do not require an exemption or executive order from CARB to be sold in California. However, California prohibits the use of any aftermarket exhaust system that modifies, removes or replaces original equipment catalysts, unless CARB has issued an Executive Order as to such part or system.

Further, Akrapovič parts or exhaust systems used or intended for use on “racing vehicles” (i.e. a competition vehicle used exclusively for competition on closed-course circuits) do not require an exemption or Executive Order from CARB to be sold in California. However, such parts are prohibited from use on California public highways or roads, even if occasionally used “off-road.”



## Installation instructions

Akrapovič Exhaust Systems:  
**Slip-On, Evolution and optional Down Pipes**  
for the  
**BMW 1 Series M Coupe** (type E82)

**Congratulations on purchasing an Akrapovič exhaust system. Please read the entire installation manual prior to undertaking any activities related to installation of your new Akrapovič exhaust system. In case you do not fully understand the manual or any of its parts, please contact your authorized dealer!**

**This product should be installed by someone with sufficient knowledge of exhaust systems and their installation, and appropriate hand or power tools. If you are not qualified for this work, please utilize a certified mechanic for installation. By installing Your Akrapovič exhaust system, you indicate that you have read the installation manual in its entirety and you agree with the terms stated herein.**

**It is your responsibility to follow all installation instruction guidelines supplied with the Akrapovič exhaust system and undertake all necessary safety precautions. Akrapovič d.d. assumes no responsibility for damages occurring from misuse, abuse, improper installation, improper operation, lack of responsible care, or all previously stated reasons resulting from incompatibility with other manufacturer's products and/or systems.**

## **IMPORTANT INFORMATION**

### **Exclusion of Certain Liability**

1. The manufacturer, importer or dealer shall not be liable for any incidental damage including personal injury or any other damages caused by improper installation or operation of the Akrapovič exhaust system. When installing the Akrapovič exhaust system be careful that the exhaust system does not touch other parts sensitive to high temperature.
2. Akrapovič makes no representation or warranties with regard to damage caused by the improper installation, use and maintenance of the Akrapovič exhaust system. The warranty is limited to defects recognized by our technical department and due to normal use, and excludes items subject to normal wear (gaskets and damping wool). The guarantee is void in case of accident, modification, improper or competition use.
3. Do not attempt to install the Akrapovič exhaust system on a vehicle model for which it was not made or tested by Akrapovič.
4. When the exhaust system gets very hot during operation, be careful not to burn yourself on the exhaust system or parts which are in direct contact with it, even when the engine is not running. Also protect other people, especially children, from the injuries mentioned above.

1. In some cases Akrapovič exhaust system kits contain chemical products (ceramic anti-seizing grease; bolt sealant). Handle with care, do not inhale or swallow. Avoid excessive contact with skin, eyes or mucous membranes. Keep out of reach of children.
2. Technical specifications of Akrapovič exhaust systems and related products are subject to change without notice.
3. Before removing the original exhaust system from your vehicle, please compare the parts you received with the list of materials provided in the installation manual in order to assure that you have all the parts necessary for the installation of your new Akrapovič exhaust system.
4. Although this manual consists of instructions for installation in written form, as well as photographs and pictures representing individual steps of the installation, please note that the photographs and pictures are symbolic and are intended for representation of general overview only. The photographs and pictures contained herein should serve as a guideline only and actual installation of the exhaust system may not correspond with the photographs and pictures entirely.
5. The process of uninstalling the original exhaust system may vary depending on the existing exhaust system. Please follow the original exhaust system manufacturer's instructions for uninstalling the original exhaust system.

### **Trademarks**

The Akrapovič Exhaust System Technology logo is a registered trademark of Akrapovič d.d.

### **Akrapovič website**

Information about Akrapovič exhaust systems and related products is available on the Akrapovič website at:

**<http://www.akrapovic.com/>**

### **Copyright**

No part of the Akrapovič exhaust system or its documentation may be reproduced or distributed in any form or by any means without the prior written authorization of the Akrapovič company.

© Akrapovič, d.d. All rights reserved.

## Symbols

The following symbols are used throughout these installation instructions:



**TOOLS REQUIRED**



**TIGHTENING TORQUE**



**INSTALLATION TIP**



**CAUTION OR WARNING**



**USE BOLT SEALANT;** Apply 3 to 4 small drops of bolt sealant onto the cleaned and degreased threads before tightening the bolts. **WARNING! Avoid contact with skin, eyes and mucous membranes. Do not inhale fumes. Keep out of the reach of children.**



**USE ANTI-SEIZE LEAD-FREE COPPER PASTE** (black tube); Provides trouble-free and long-lasting protection against seizing, corrosion and rusting of bolts, threaded ends, nuts, joints, etc. Also protects against vibration, wear and impact. **WARNING! Avoid eye contact. Avoid excessive skin contact. Keep out of reach of children.**



**USE ANTI-SEIZING GREASE** (white tube); Prevents seizing, corrosion and excessive wear between the titanium components of your exhaust system. **WARNING! Avoid eye contact. Avoid excessive skin contact. Keep out of reach of children.**



T-handle swivelling 13 mm wrench  
T-handle swivelling 14 mm wrench  
Torx 25  
Torx 40  
Torx 50  
Torx E10  
Torx E12  
T-handle 8 mm wrench  
T-handle 12 mm wrench  
T-handle 18 mm wrench  
Combination 13 mm wrench  
Combination 16 mm wrench



**BEFORE INSTALLING, CHECK SCHEMATIC OF THE EXHAUST SYSTEM! THE LATEST VERSION OF THE PARTS LIST AND SCHEMATIC DRAWINGS OF THE PRODUCTS ARE AVAILABLE ON OUR WEB PAGE.**



**IF ANY ITEMS IN THE AKRAPOVIČ EXHAUST SYSTEM PACKAGE ARE MISSING, PLEASE CONTACT YOUR AUTHORIZED DEALER. KEEP THE SCHEMATIC FOR FUTURE REFERENCE.**



**THESE INSTALLATION INSTRUCTIONS MUST BE READ CAREFULLY IN ORDER TO ENSURE PROPER INSTALLATION AND OPERATION OF THE AKRAPOVIČ EXHAUST SYSTEM.**



**THE EXHAUST SYSTEM CAN BE EXTREMELY HOT. ALLOW THE EXHAUST AND ENGINE TO COOL DOWN BEFORE BEGINNING INSTALLATION.**



**WE ADVISE YOU TO LEAVE INSTALLATION TO A QUALIFIED SERVICEMAN. IMPROPER INSTALLATION MAY RESULT IN A SHORTER LIFETIME OF THE EXHAUST SYSTEM AND/OR DAMAGE TO THE VEHICLE.**



**THIS MANUAL IS SPECIFIC TO THE BMW 1 SERIES M COUPE. THERE MAY BE SOME DIFFERENCES IN INSTALLATION PROCEDURES FOR OTHER MODELS.**



**WHEN INSTALLING AKRAPOVIČ'S AFTERMARKET OPTIONAL DOWN PIPES WITHOUT CATALYTIC CONVERTERS, WHICH ARE DEVELOPED FOR USE ON CLOSED TRACKS ONLY, REMAPPING OF THE ECU IS MANDATORY. THE AKRAPOVIČ COMPANY TAKES NO RESPONSIBILITY FOR ECU REMAPPING OR ANY POTENTIAL ISSUES RELATED TO THE USE OF AKRAPOVIČ DOWN PIPES.**

## **REMOVAL OF ORIGINAL EXHAUST SYSTEM:**

Put the vehicle onto a car lift.

**!** **WARNING:** ensure that the car is lifted safely and properly in order to avoid the risk of vehicle damage, injury, or even death!

1. **For Slip-On:** unscrew the marked flange bolts and carefully pull the rubber bracket off the pipe's bracket (**Figure 1**).

**✂** **INSTALLATION TIP:** for easier dismounting, lubricate the rubber bracket (WD40).

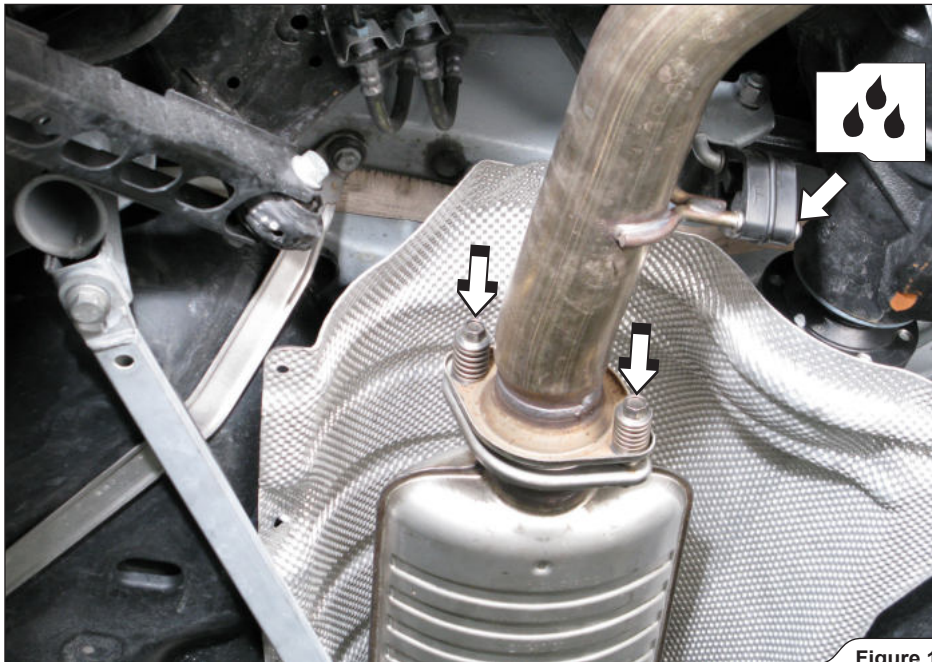

Figure 1



2. **For Slip-On:** carefully pull the rubber brackets off the muffler's brackets on both sides and remove the original muffler off the vehicle (**Figure 2**).

! **WARNING:** make sure, not to damage any part of the vehicle during this procedure!

✂ **INSTALLATION TIP:** for easier dismounting, lubricate the original rubber brackets (WD40).

! **WARNING:** make sure, that you support the original muffler during this procedure or you could injure yourself or damage the vehicle!

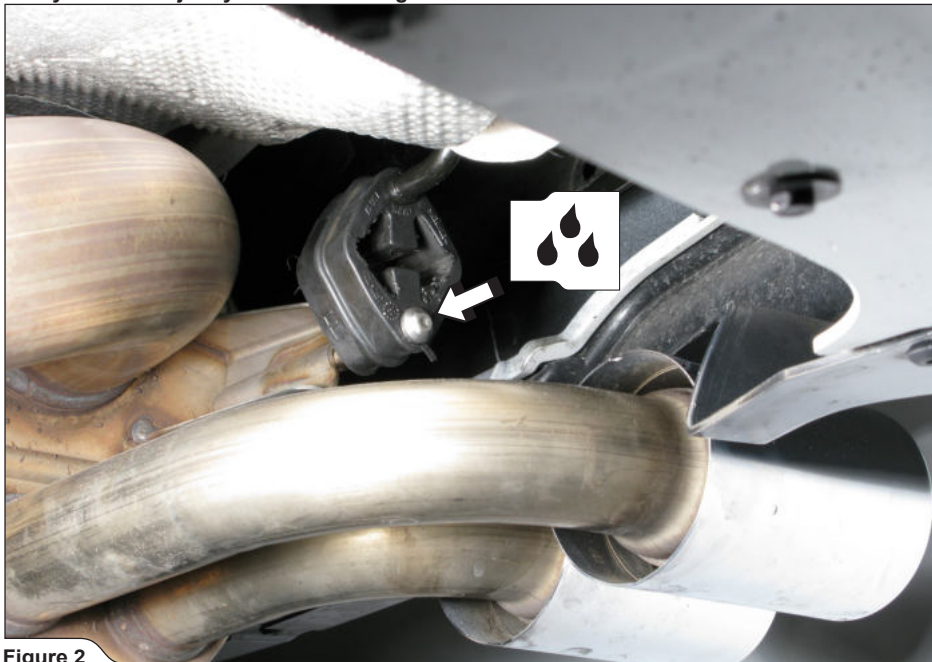

Figure 2

3. **For Evolution:** unscrew the marked bolts and remove the chassis reinforcement off the vehicle (**Figure 3**).

! **WARNING:** make sure not to injure yourself, or damage any part of the vehicle during this procedure!

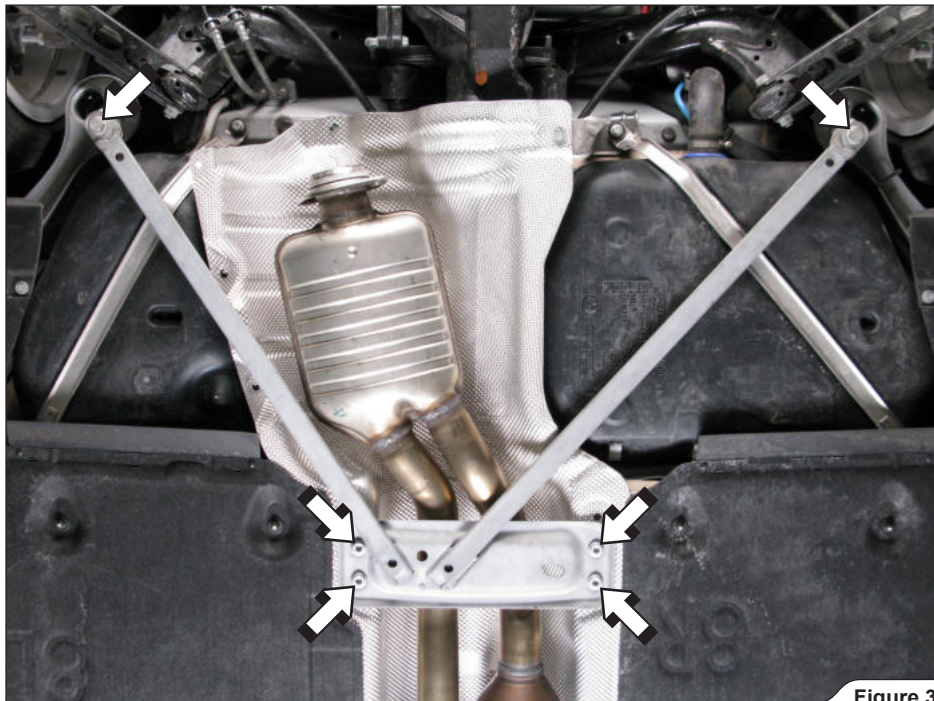

Figure 3

4. **For Evolution:** unscrew the link pipes' bracket (**Figure 4**).

**!** **WARNING:** make sure not to injure yourself, or damage any part of the vehicle during this procedure!



Figure 4

5. **For Evolution:** unscrew the marked flange nuts and remove the link pipes off the vehicle (Figure 5).

**!** **WARNING:** make sure, that you support the link pipes during this procedure or you could injure yourself or damage the vehicle!

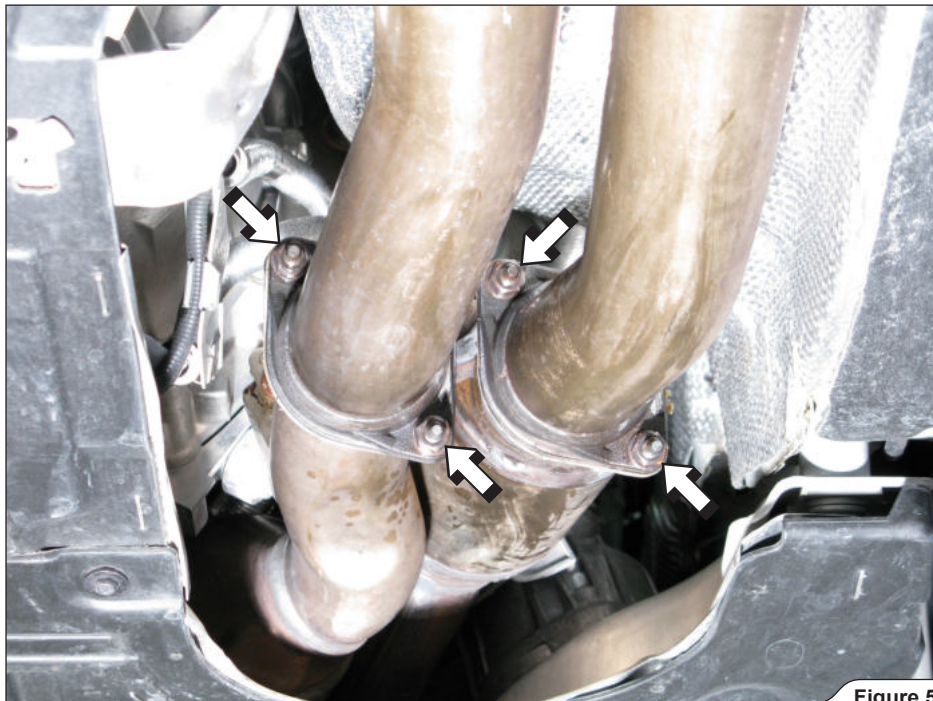

Figure 5

6. **For Evolution:** loosen the marked down pipes' bracket nuts (**Figure 6**).



**Figure 6**

7. **For optional Down Pipes:** unscrew the marked bolts and remove the engine/transmission shields off the vehicle (**Figure 7, 8**).

**!** **WARNING:** make sure not to injure yourself, or damage any part of the vehicle during this procedure!

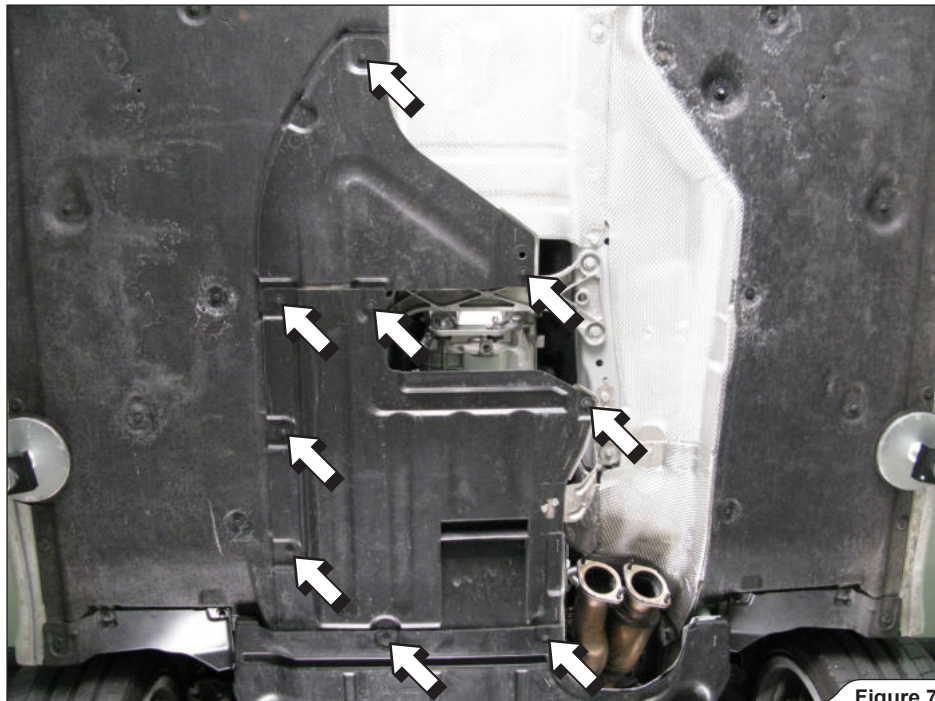

Figure 7

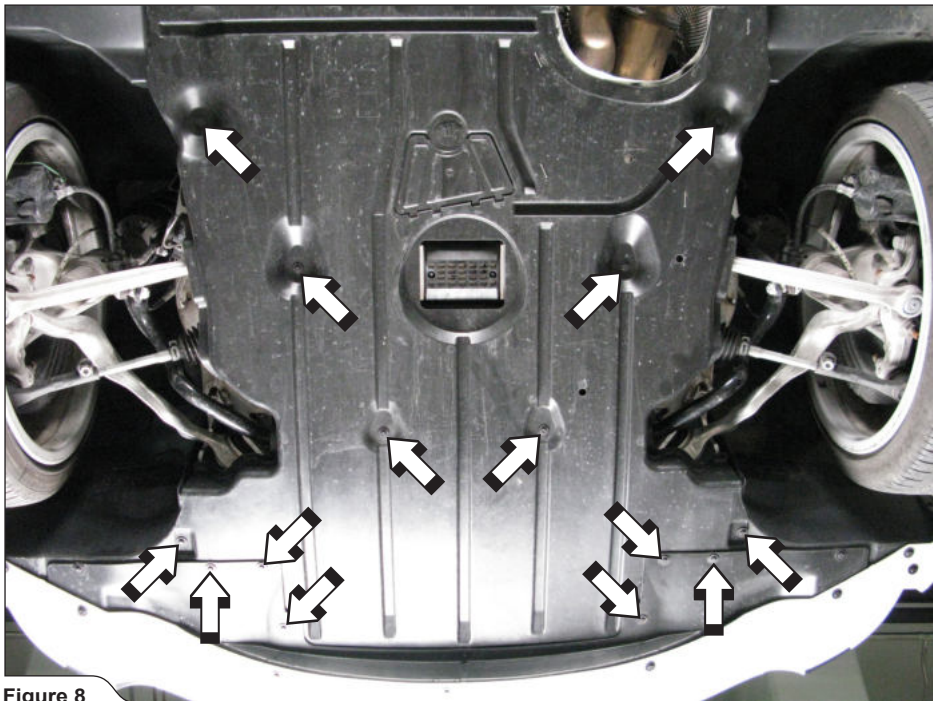

Figure 8

8. **For optional Down Pipes:** unscrew the marked bolts and partially remove the power steering (Figure 9).

**! WARNING:** make sure not to injure yourself, or damage any part of the vehicle during this procedure!

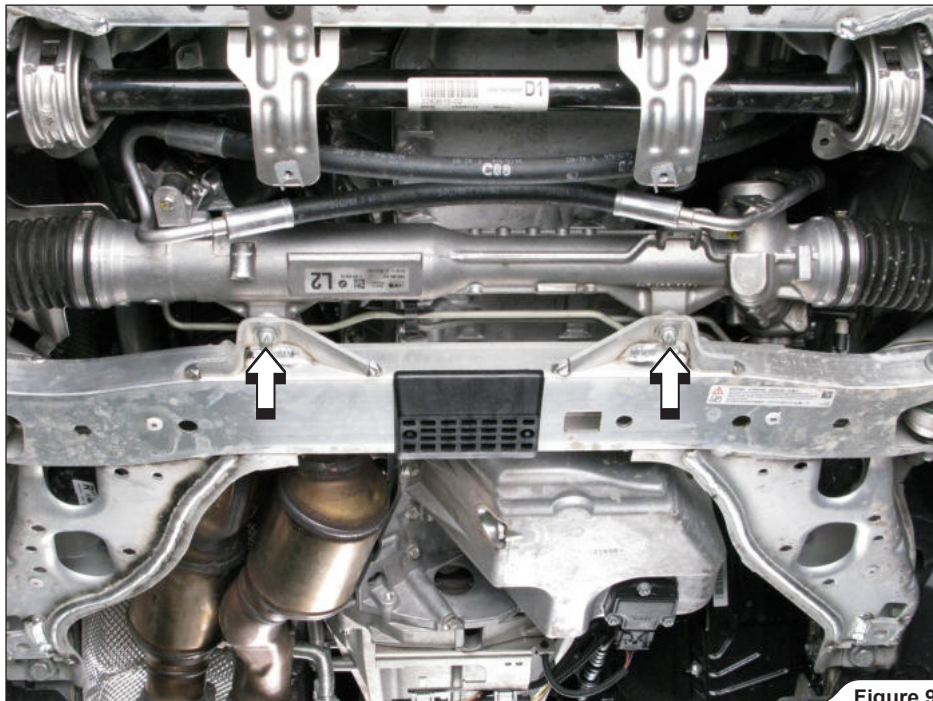

Figure 9



9. **For optional Down Pipes:** unscrew the three marked bolts and remove the power steering heat shield (Figure 10).

**! WARNING:** make sure not to injure yourself, or damage any part of the vehicle during this procedure!

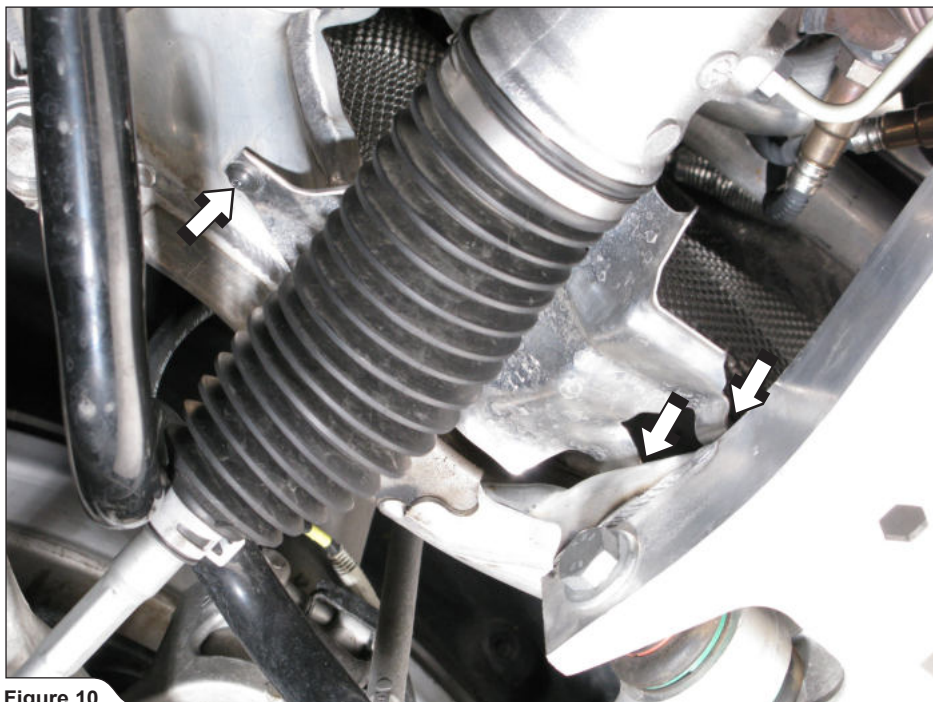

Figure 10

10. For optional Down Pipes: disconnect the rear lambda sensors' connectors (Figure 11).

**!** **WARNING:** make sure not to damage the connectors, or any other part of the vehicle during this procedure!

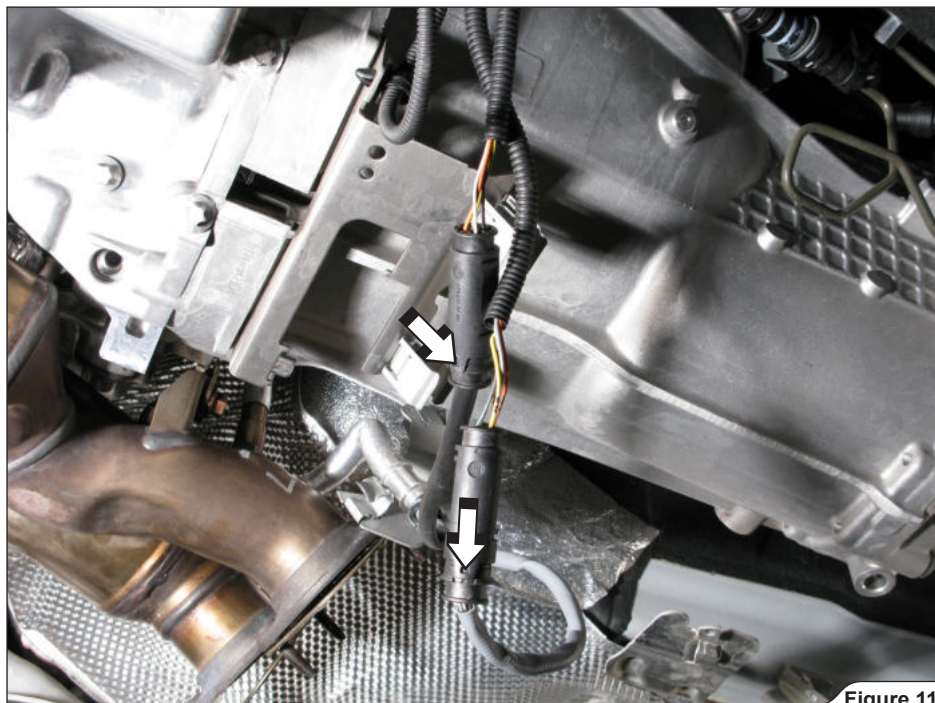

Figure 11

11. For optional Down Pipes: unscrew the rear lambda sensors out of the down pipes (Figure 12).
- ! **CAUTION:** be careful not to damage the electrical leads or the lambda sensors during this procedure!

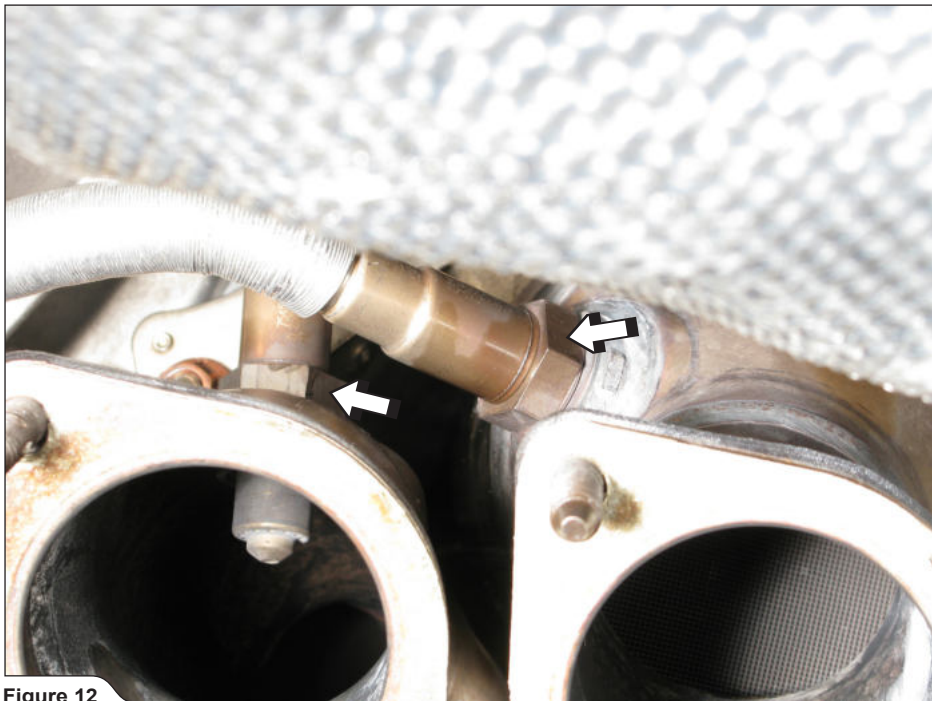

Figure 12

12. **For optional Down Pipes:** unscrew the marked bolt and remove the rear lambda sensors electrical lead bracket (**Figure 13**).

**!** **WARNING:** make sure not to injure yourself, or damage any part of the vehicle during this procedure!

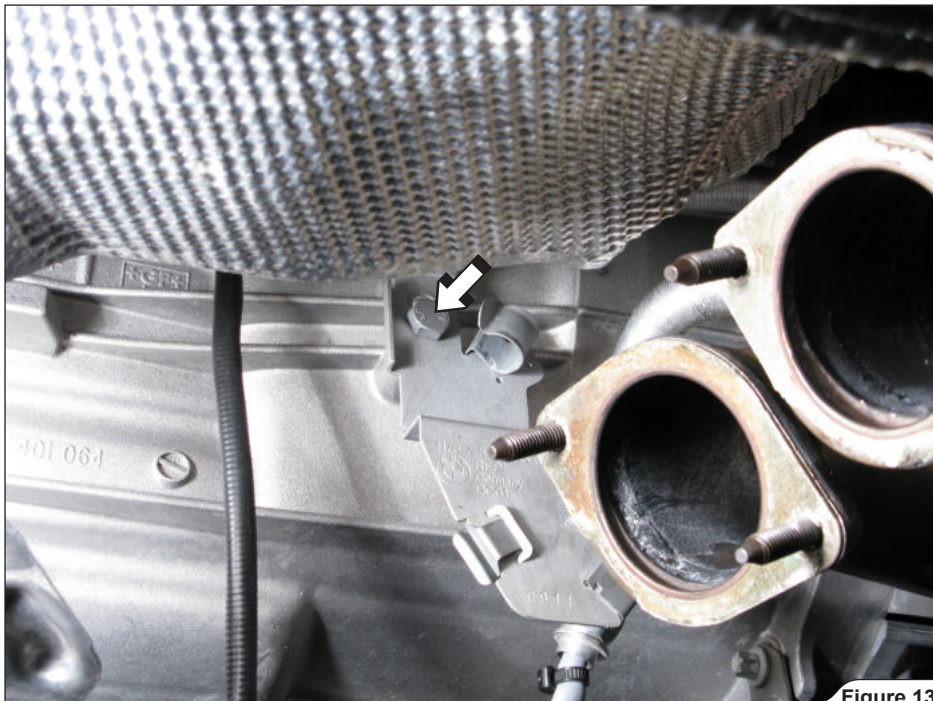

Figure 13

13. **For optional Down Pipes:** unscrew the front lambda sensors out of the down pipes (Figure 14).

! **CAUTION:** be careful not to damage the electrical leads or the lambda sensors during this procedure!

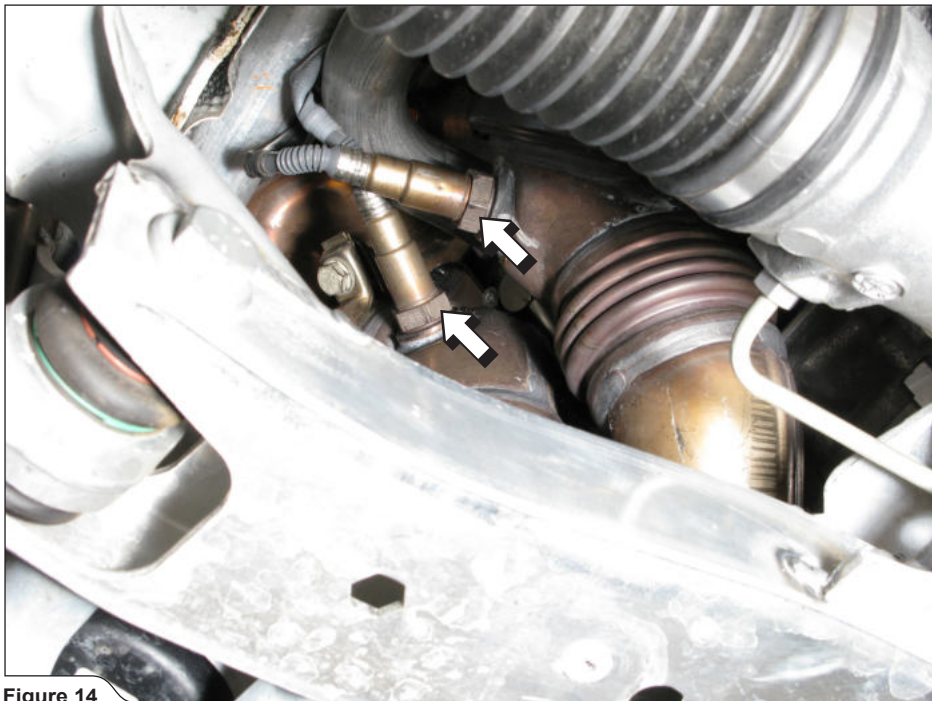

Figure 14

14. For optional Down Pipes: unscrew and remove the two marked spherical clamps (Figure 15).

**!** **WARNING:** make sure not to injure yourself, or damage any part of the vehicle during this procedure!



Figure 15

15. **For optional Down Pipes:** fully unscrew the down pipes' bracket nuts and carefully remove the down pipes off the vehicle (**Figure 16**).

! **WARNING:** make sure not to injure yourself, or damage any part of the vehicle during this procedure!

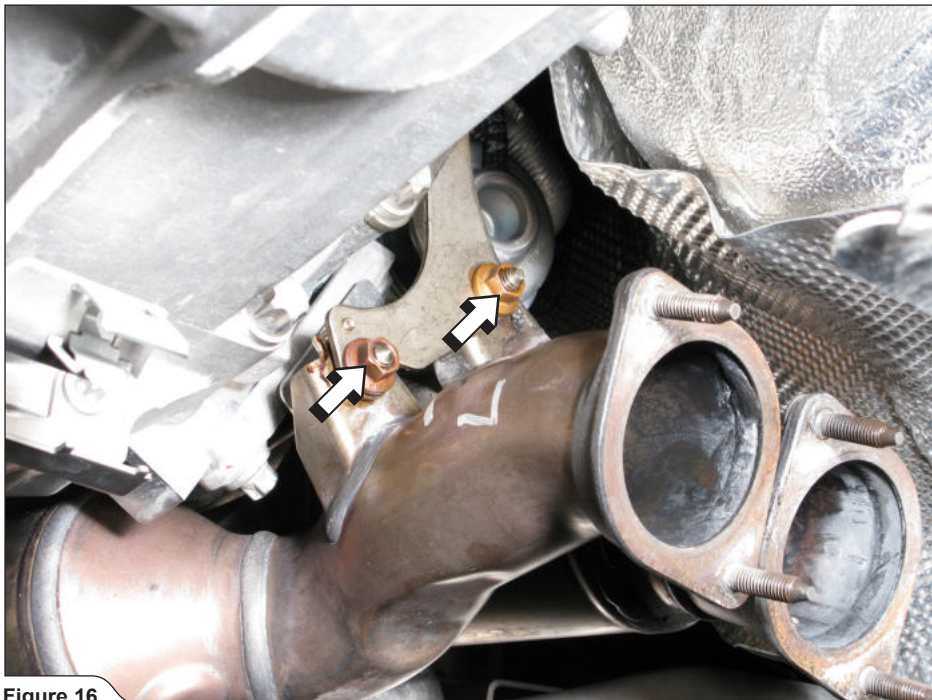

Figure 16

## **INSTALLATION OF THE AKRAPOVIČ EXHAUST SYSTEM:**

1. **For optional Down Pipes:** attach the Akrapovič Down Pipes (**the right Down Pipe first!**) onto the vehicle, using original spherical clamps; hand tighten the clamps only (**Figure 17**).

**! CAUTION:** use new exhaust gaskets in turbo chargers - Akrapovič Down-Pipes joints!

**! WARNING:** do not fully tighten the clamps yet!

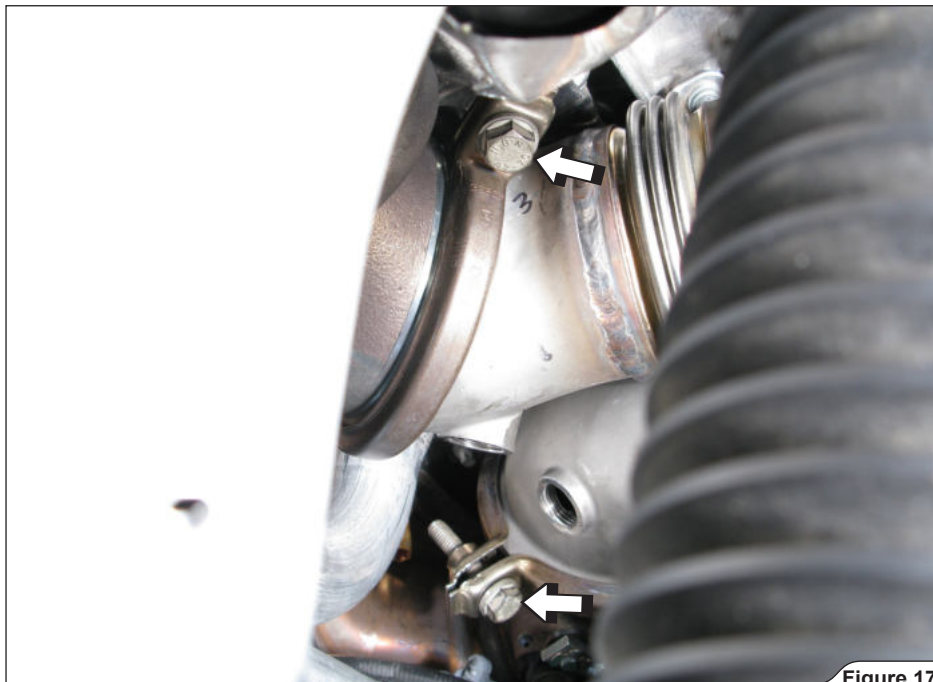

**Figure 17**



2. **For Optional Down Pipes:** align the Down Pipes and hand tighten the bracket using original nuts; install the rear lambda sensors (**Figure 18**).

! **WARNING:** use anti-seize copper paste only on lambda sensors' threads!

! **CAUTION:** be careful not to damage the electrical leads or the lambda sensors during this procedure!

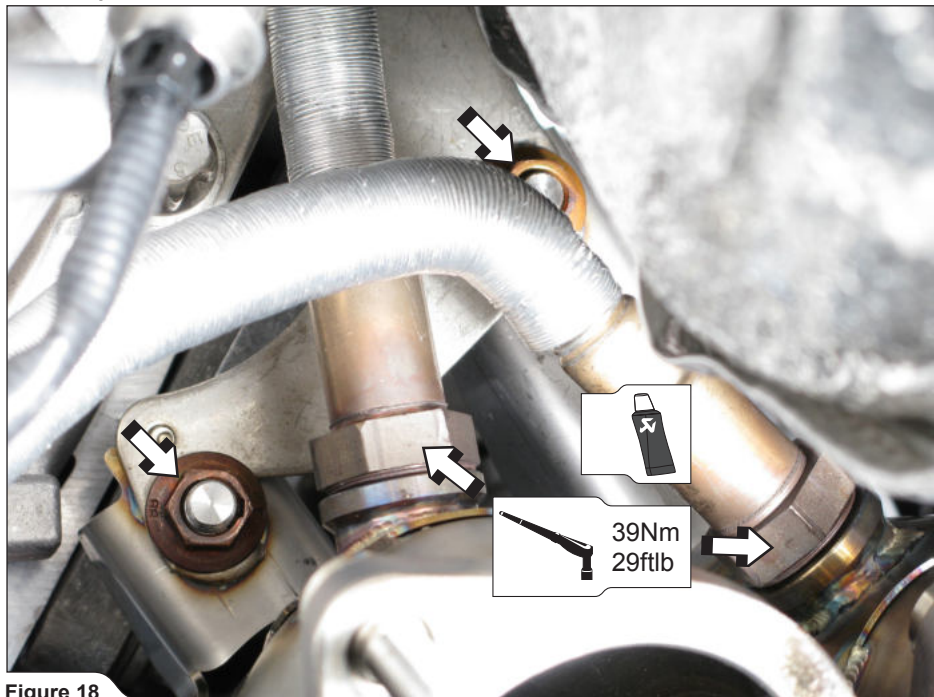

Figure 18

3. **For optional Down Pipes:** tighten the original spherical clamps to the specified torque (Figure 19).

! **CAUTION:** make sure, that Down Pipes' inlet flanges are correctly assembled with the original turbo chargers' flanges, before tightening the spherical clamps!

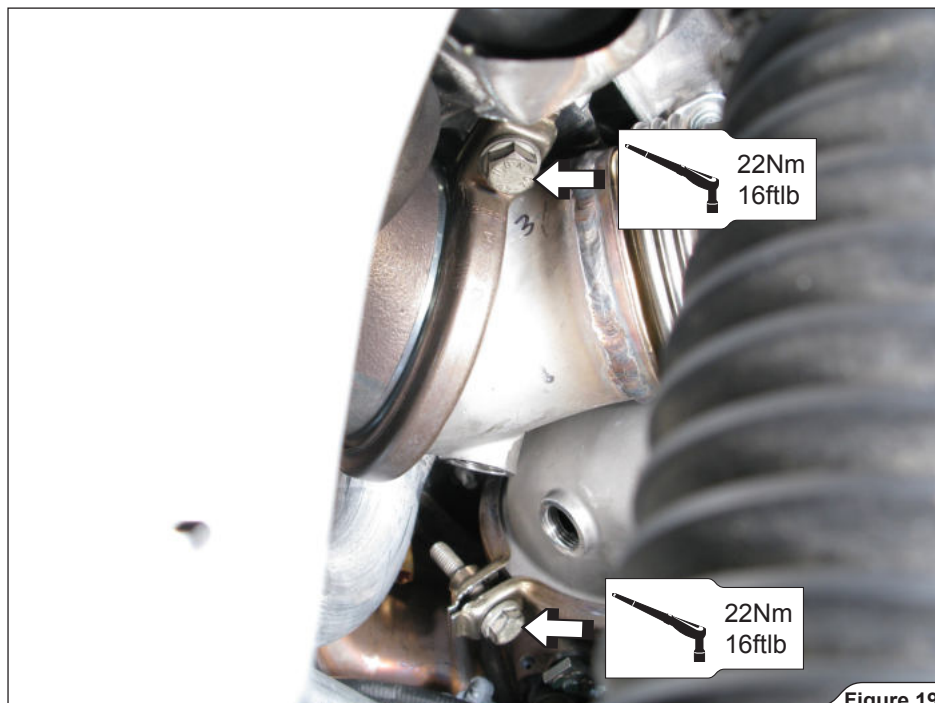

Figure 19

4. **For Optional Down Pipes:** install the front lambda sensors into the Down Pipes (**Figure 20**).
- ! **WARNING:** use anti-seize copper paste only on lambda sensors' threads!
  - ! **CAUTION:** be careful not to damage the electrical leads or the lambda sensors during this procedure!

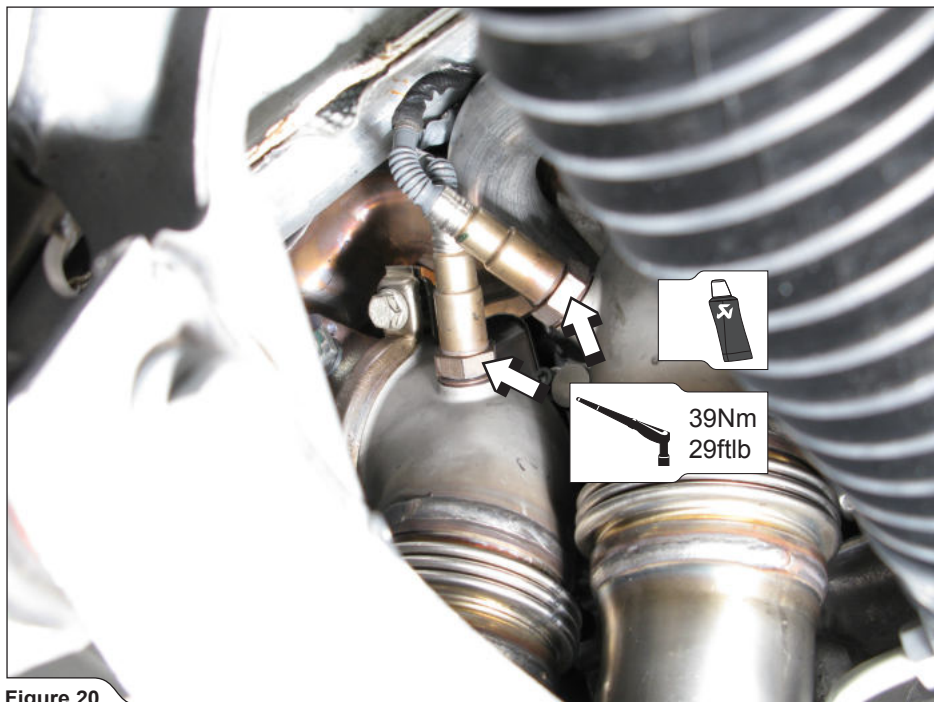

Figure 20

5. **For optional Down Pipes:** correctly assemble the rear lambda sensors' connectors and reinstall the sensors electrical leads bracket (**Figure 21**).

! **WARNING:** make sure, that sensors' electrical leads don't touch any hot or moving parts!

! **WARNING:** in case of installation of optional Down Pipes, remapping of ECU is necessary!

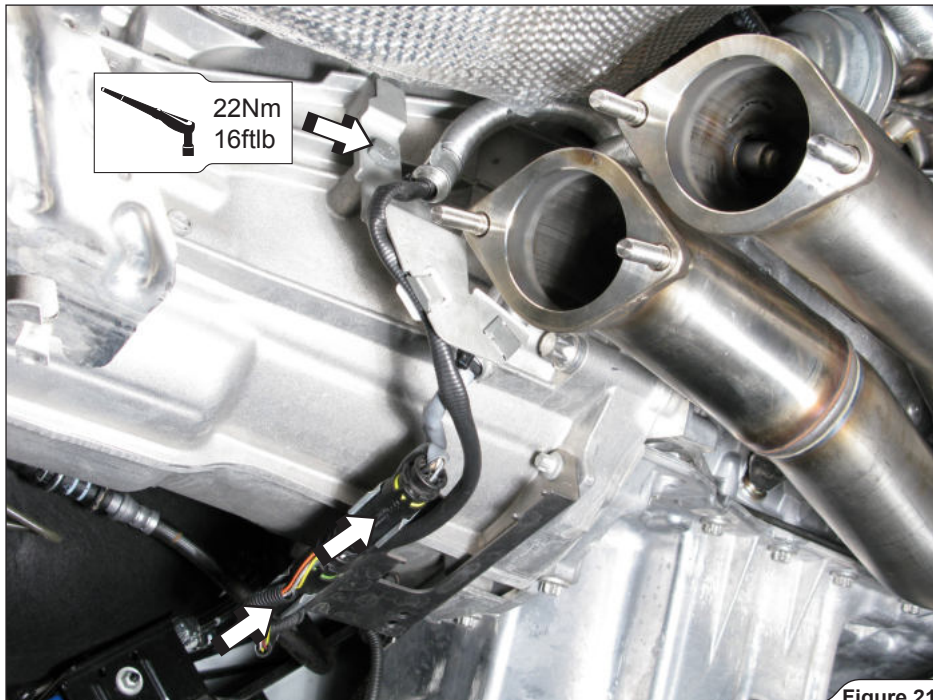

Figure 21

6. **For Evolution:** assemble the Akrapovič Evolution Link Pipes onto the Down Pipes, using original nuts (**Figure 22**).

! **CAUTION:** use new original exhaust gaskets in Evolution Link Pipes - Down Pipes joints!

! **WARNING:** do not fully tighten the nuts yet!

! **WARNING:** make sure not to injure yourself, or damage any part of the vehicle during this procedure!

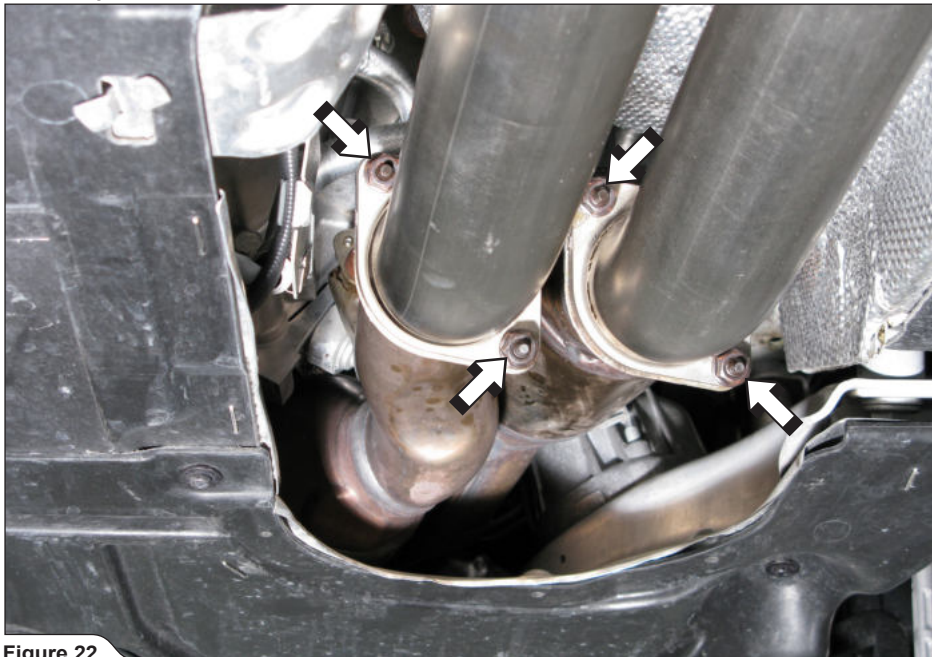

Figure 22

7. **For Evolution:** attach the Akrapovič Evolution Link Pipes' bracket onto the chassis using stock bolts and nuts and assemble the Akrapovič clamp onto the bracket using Akrapovič bolt and washer; hand tighten all bolts only (**Figure 23**).

! **WARNING:** use anti-seize copper paste on all bolts and nuts threads!

! **WARNING:** do not fully tighten the bolts and nuts yet!

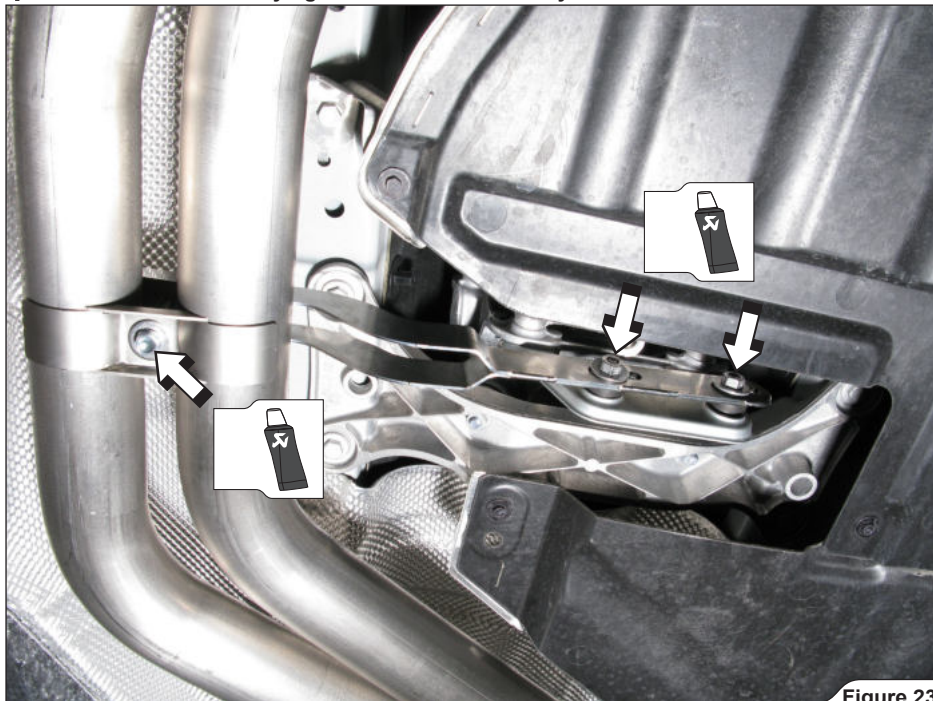

Figure 23

8. **For Evolution:** carefully slide the graphite conical gasket from Akrapovič installation kit onto the Collector's outlet (**Figure 24**).

! **WARNING:** be careful not to damage the graphite gasket during this procedure!

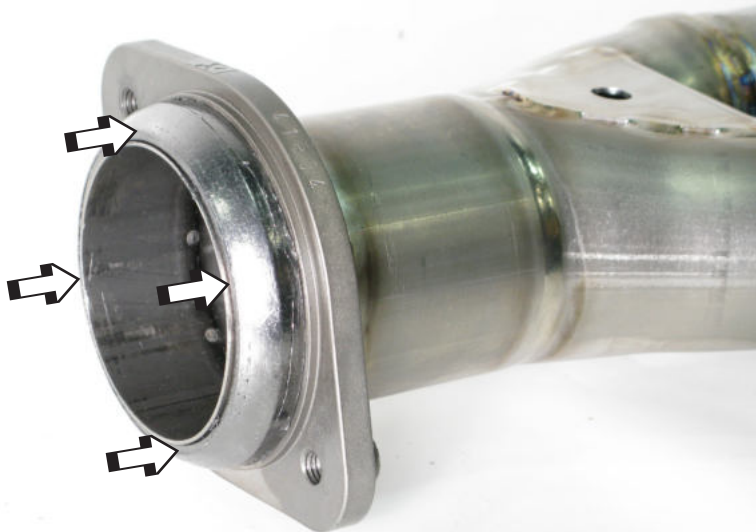

Figure 24

9. **For Evolution:** correctly orient and slide the clamps from Akrapovič installation kit onto the Collector's inlets (**Figure 25**).

! **WARNING:** use anti-seize copper paste on clamps' bolts and nuts threads!

! **WARNING:** do not tighten the clamps yet!



Figure 25



10. **For Evolution:** slide the Collector all the way onto the Evolution Link Pipes. Align the Evolution Link Pipe and Collector in respect to the chassis and hand tighten the clamps (**Figure 26**).

! **WARNING:** make sure not to injure yourself, or damage any part of the vehicle during this procedure!

! **WARNING:** do not tighten the clamps yet!



Figure 26

11. **For Slip-On:** assemble the clamps and Connecting Pipe onto the muffler's inlet pipes, as shown (Figure 27, 28).

! **WARNING:** use anti-seize copper paste on all clamps' bolt and nut threads!

! **CAUTION:** in case you choose to grind off the spot welds and brake the connecting pipe's seal off, the Akrapovič exhaust system EC type approval is not valid!



Figure 27

**!** WARNING: hand tighten the clamps only!

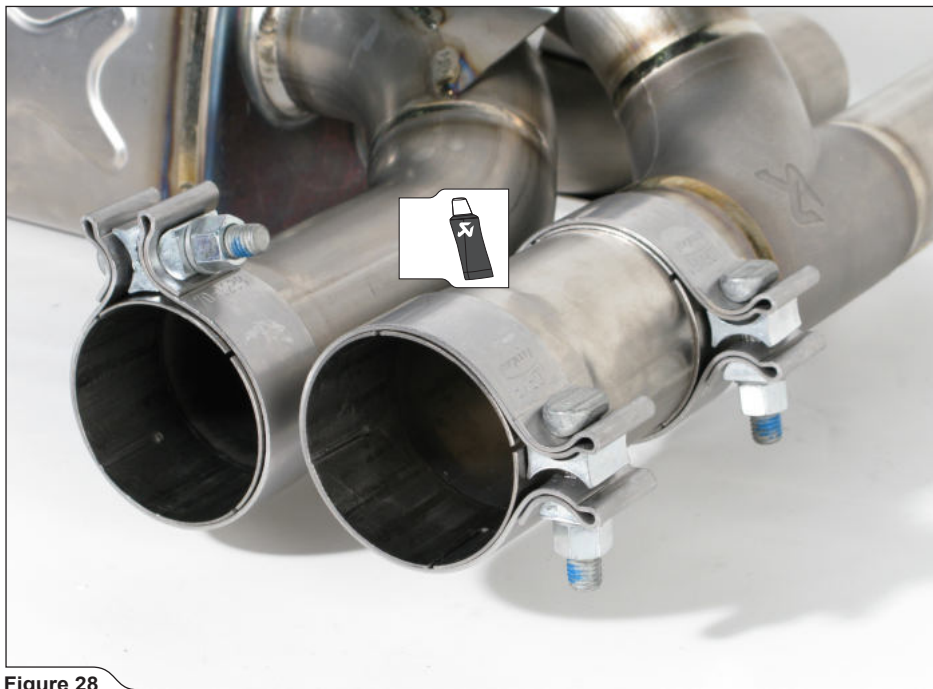

**Figure 28**

12. **For Slip-On:** assemble the Slip-On Link Pipe with the muffler's inlet pipes and hand tighten the clamps (**Figure 29**).

**!** **WARNING:** do not fully tighten the clamps yet!



**Figure 29**

13. **For Slip-On in combination with original link pipes only:** correctly assemble the gasket and Slip-On adapter (Akrapovič installation kit) into the link pipe's inlet (**Figure 30, 31**).

**!** **CAUTION:** the gasket and Slip-on adapter are used only in combination of Slip-On and original link pipes!



**Figure 30**

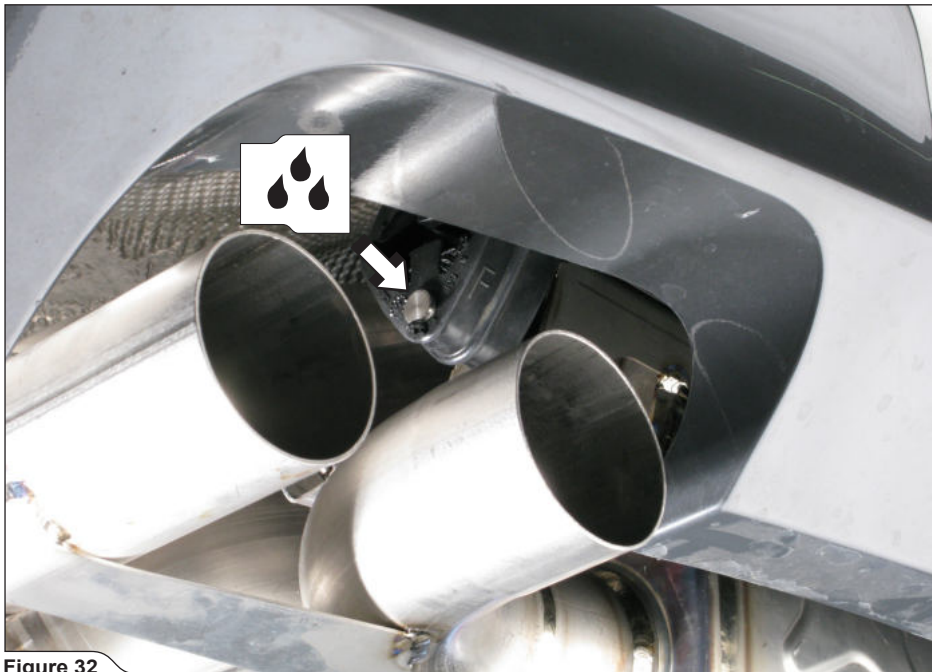

Figure 31

14. **For Slip-On and Evolution:** hang the muffler with Slip-On Link Pipe onto all three original rubber brackets. Center the muffler in respect to the rear bumper's tail pipe outlets and tighten the flange, using original springs and bolts (**Figure 32, 33, 34**).

**✂** **INSTALLATION TIP:** for easier mounting, lubricate the original rubber brackets (WD40).

**!** **WARNING:** make sure, that you support the muffler during this process or you could injure yourself or damage the vehicle!



**Figure 32**

! **WARNING:** in case of Slip-On exhaust system in combination with original link pipes, use Slip-On adapter and gasket from Akrapovič installation kit and original conical gasket in this joint (Figure 33)!

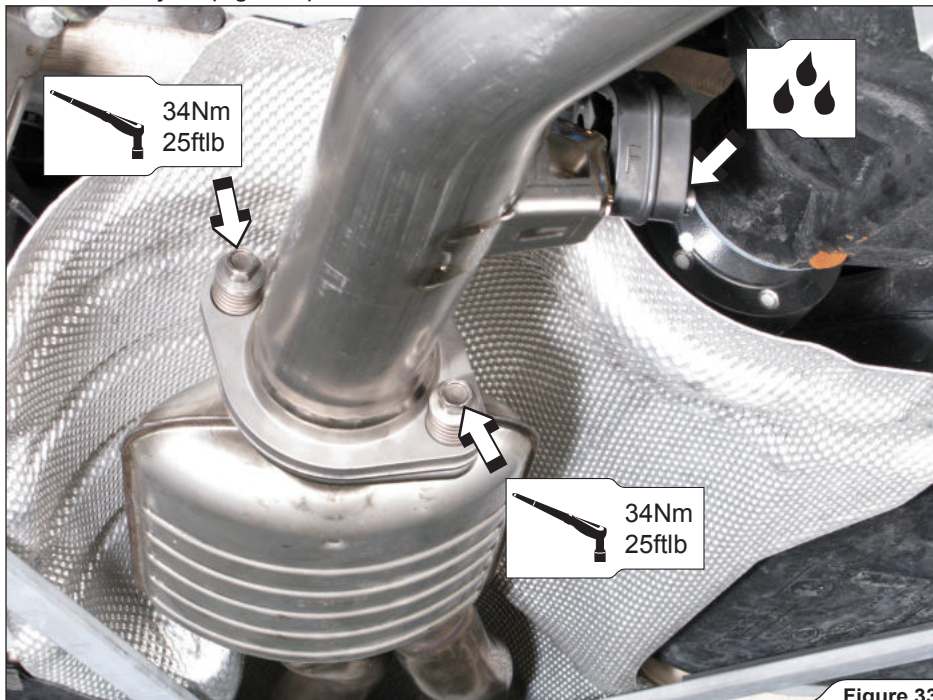

Figure 33



**!** **WARNING:** in case of Evolution exhaust system, use only graphite conical gasket from Akrapovič installation kit in this joint (Figure 34)!

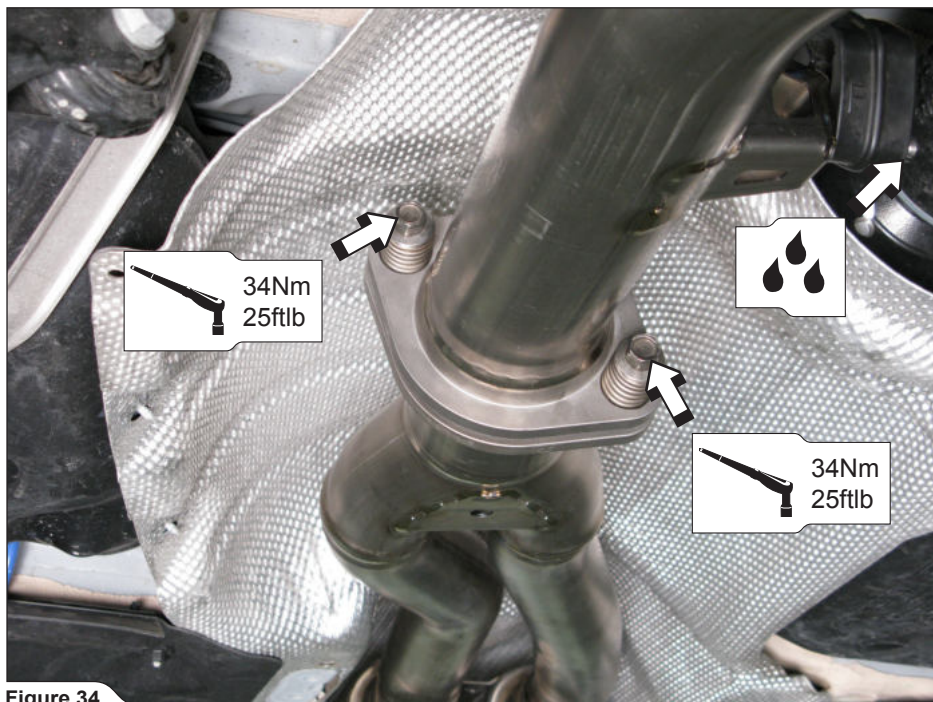

Figure 34

15. **For Evolution:** align the Collector and Evolution Link Pipes in respect to the chassis and tighten the clamps to a specified torque (**Figure 35**).

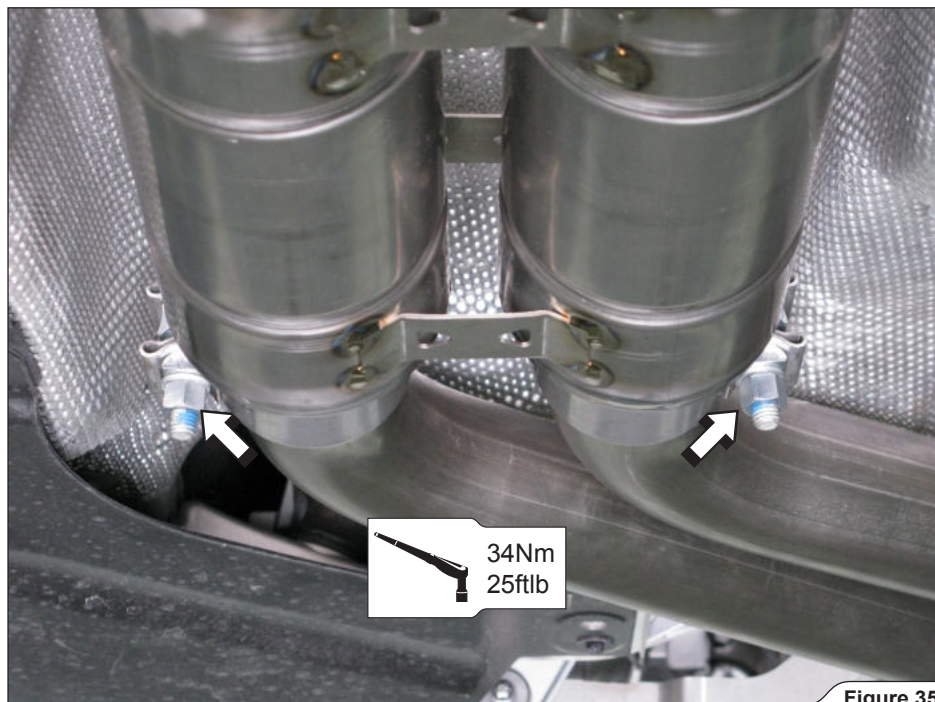

Figure 35

16. **For Evolution:** tighten the Evolution Link Pipes' bracket bolts to the specified torque (**Figure 36**).

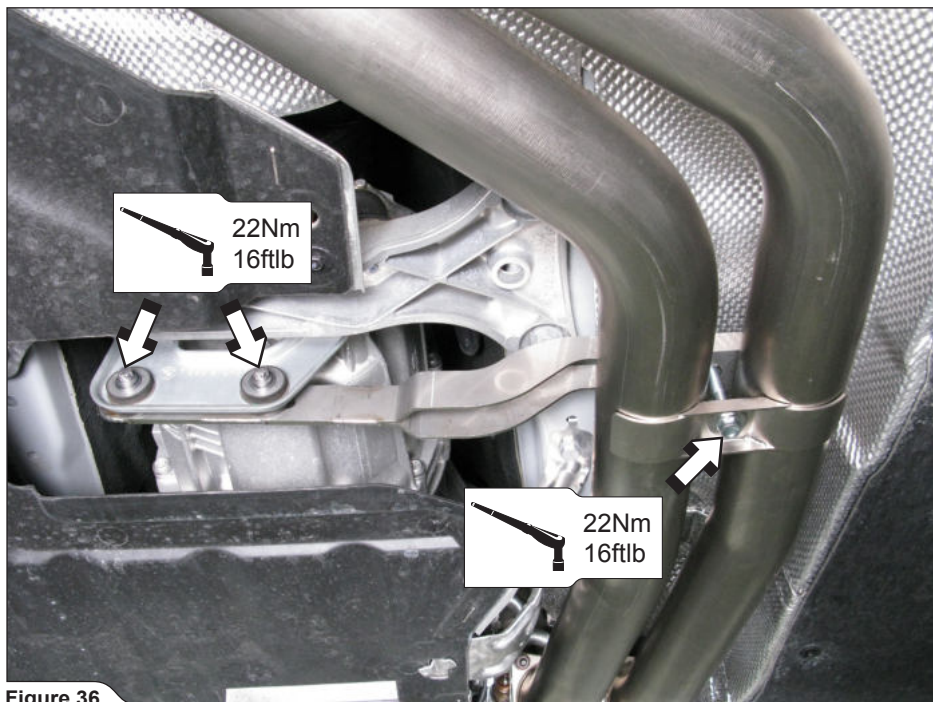

Figure 36

17. **For Evolution:** tighten the flange nuts to a specified torque (**Figure 37**).

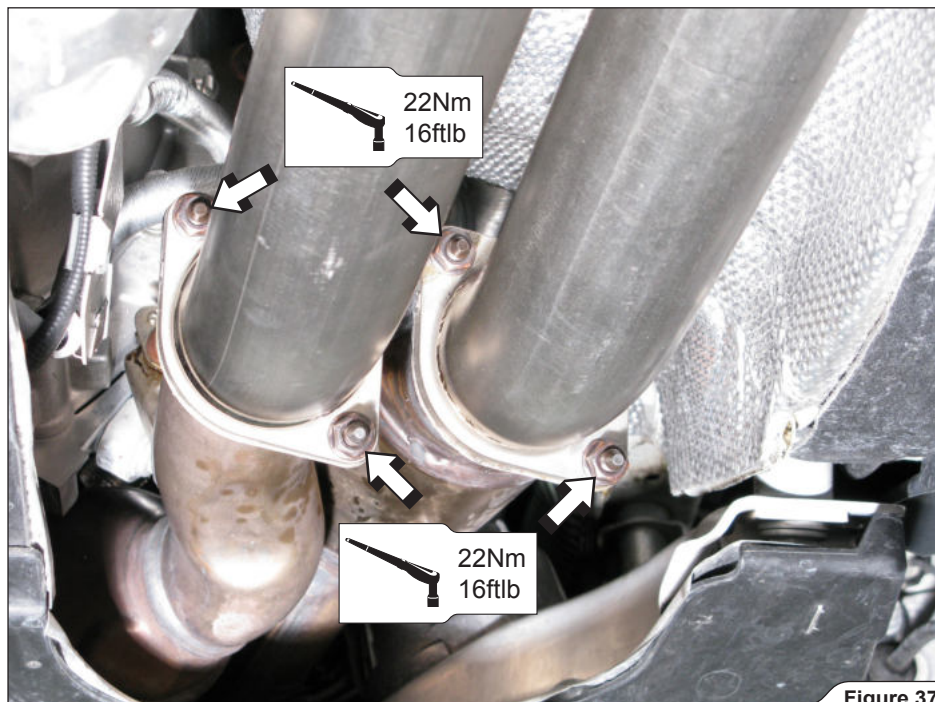
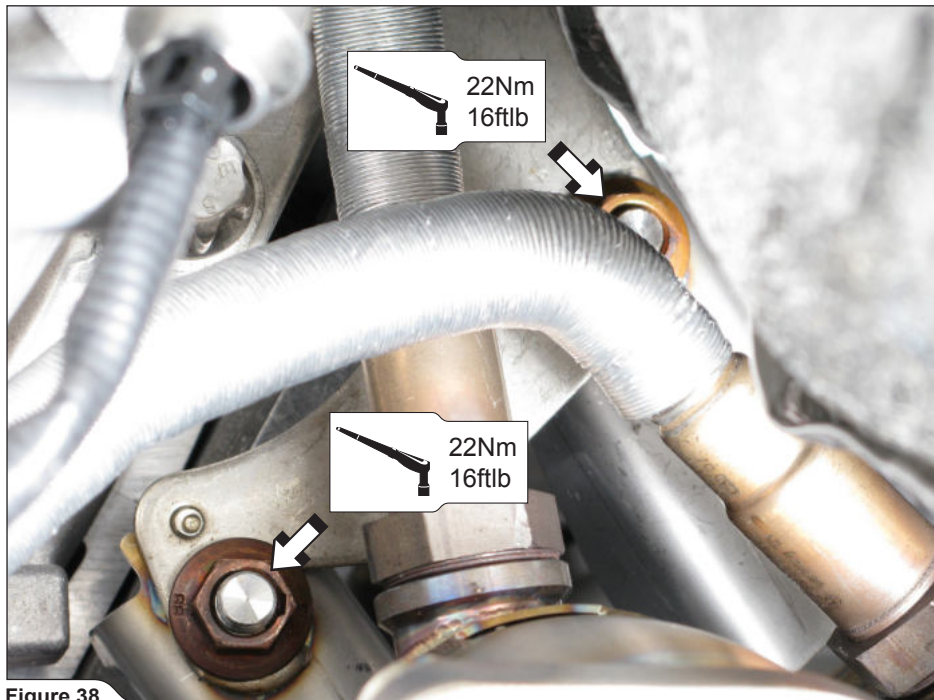

Figure 37

18. **For Evolution and optional Down Pipes:** tighten the Down Pipes bracket nuts to a specified torque (**Figure 38**).



**Figure 38**

19. **For Slip-On:** align the muffler in respect to the rear bumper's tail pipe outlets and tighten the clamps to the specified torque (**Figure 39**).

! **WARNING:** make sure, not to injure yourself or damage any part of the vehicle during this procedure!

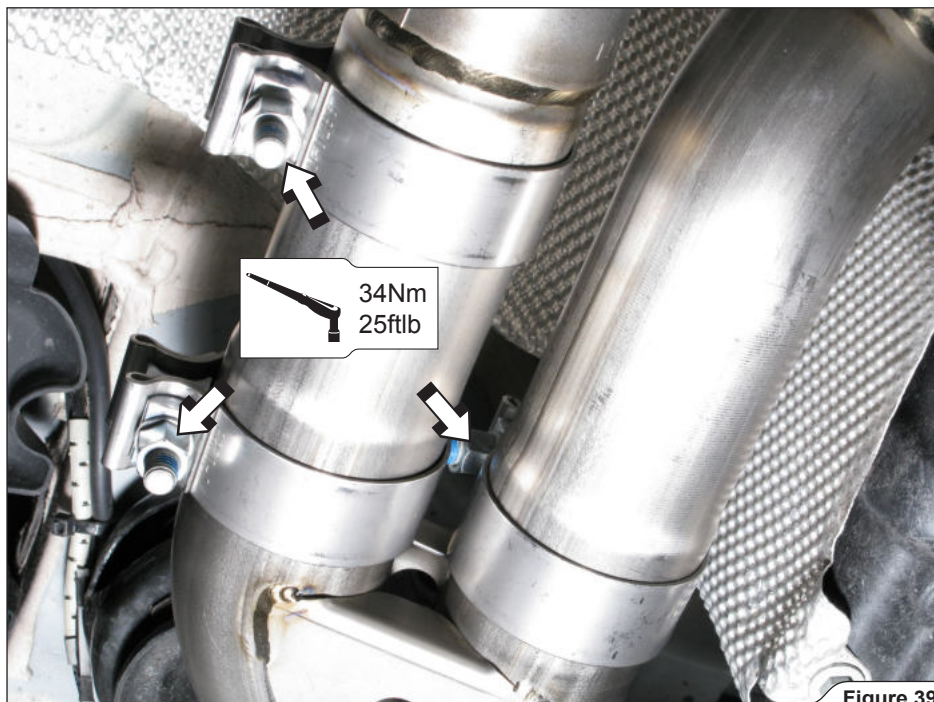

Figure 39

20. **For all exhaust systems:** make sure, that clearances between Akrapovič exhaust components and vehicle chassis are sufficient (**Figure 40**).

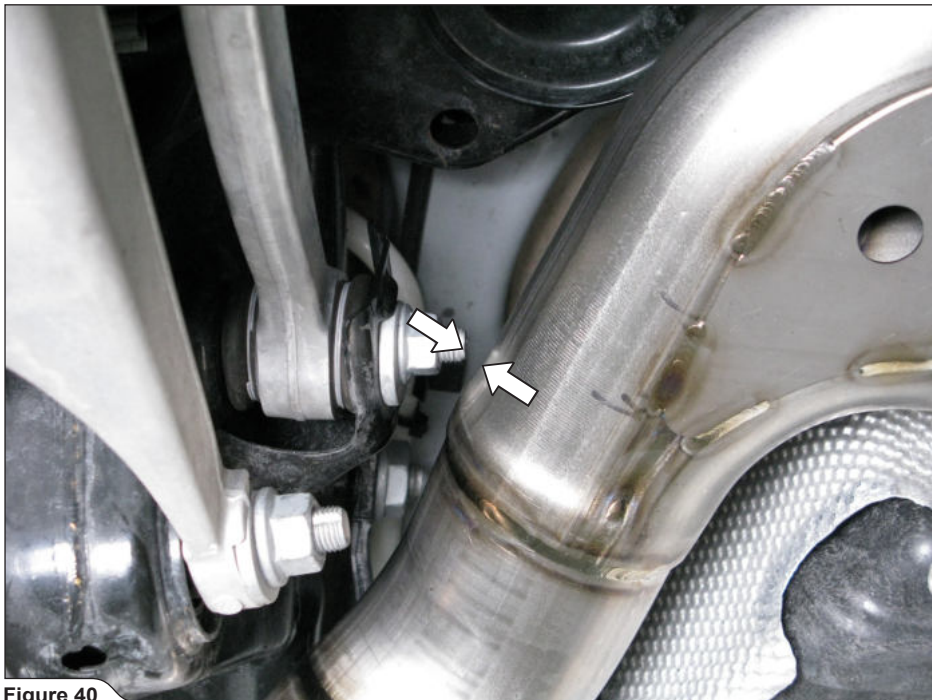
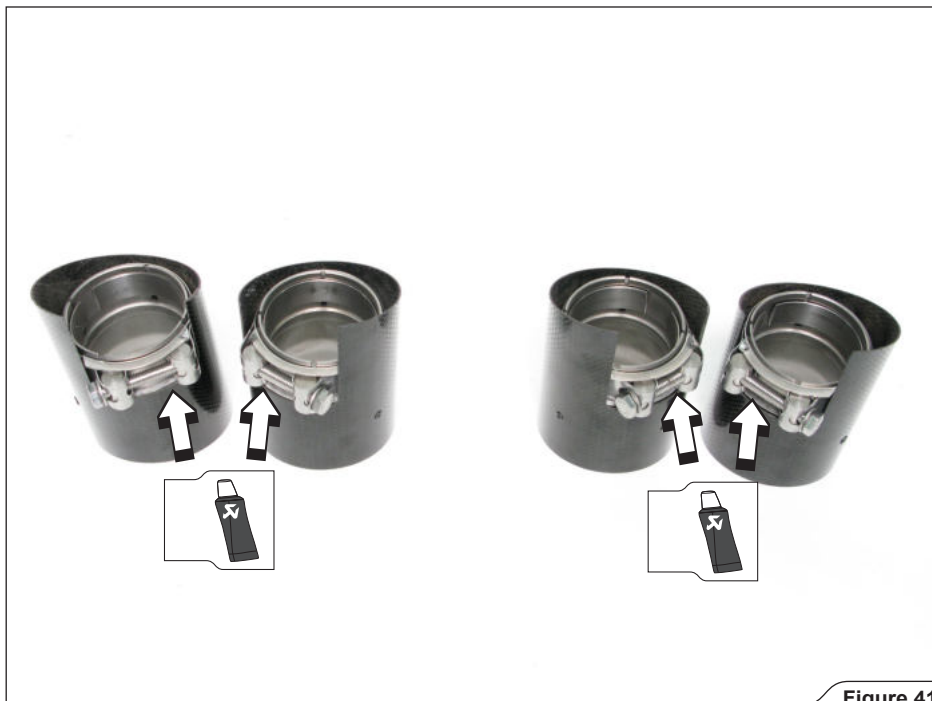

Figure 40

21. **For Slip-On:** assemble the clamps and spherical rings onto the Tail Pipes, as shown (**Figure 41**).

**! WARNING:** use anti-seize copper paste on clamp bolt threads!



**Figure 41**



22. **For Slip-On:** slide the tail-pipes onto the muffler outlets. Rotate and center them in respect to rear bumper and according to your personal taste (Figure 42, 43).

! **WARNING:** make sure, not to damage Tail Pipes, bumper or any part of the vehicle during this procedure!



Figure 42



**Figure 43**

23. **For Slip-On:** tighten tail pipe clamps to the specified torque on both sides of the vehicle (Figure 44).

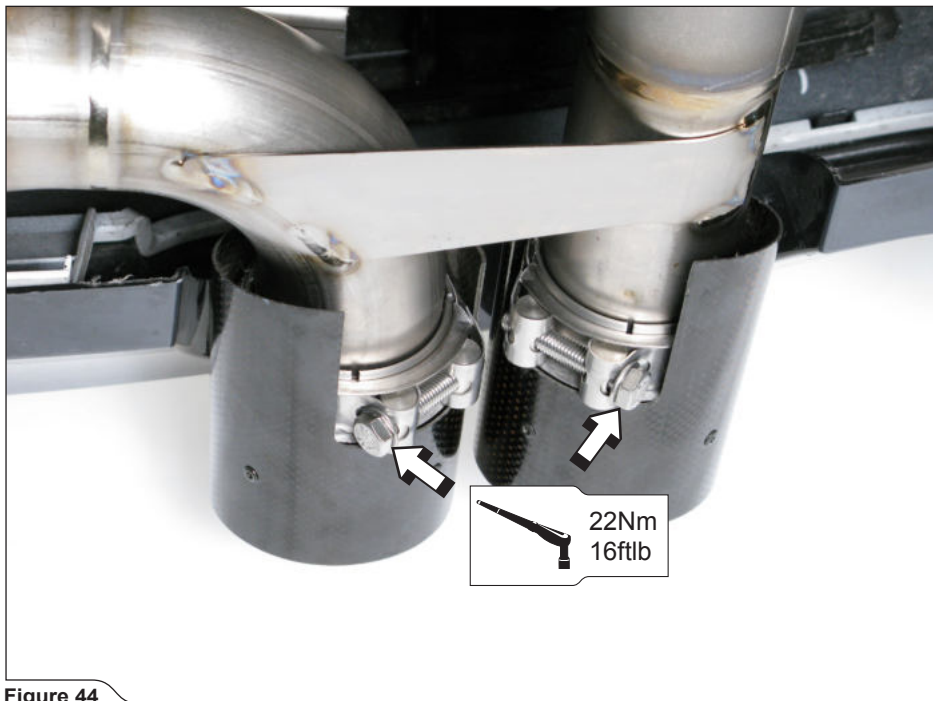

Figure 44

## Final installation:

- ! **WARNING: check vehicle manufacturer manual for tightening torques (for dismounted stock parts)!**
- ! **WARNING: make sure all the nuts and bolts are sufficiently tightened. In case the exhaust system touches the cowl or other parts, repeat the adjustment of the exhaust system or contact your authorized dealer.**

## **MAINTENANCE OF THE AKRAPOVIČ EXHAUST SYSTEM:**

1. Clean the titanium exhaust components with a multi-purpose spray lubricant (WD-40 or equivalent), carbon fiber exhaust components with soft and dry cloth and stainless steel components with soft cloth sprayed with contact cleaner, then wipe with soft and dry cloth. A change in the color of the exhaust system is normal due to high temperatures.
2. Periodically make sure all the bolts and springs are sufficiently tight.

- ! **WARNING: clean all exhaust components before the first start of the engine or the stains will burn onto the surfaces!**
- ! **IT IS NORMAL IF WHITE SMOKE COMES OUT OF THE MUFFLER ON FIRST OPERATION.**
- ! **DO NOT STAND BEHIND THE MUFFLER ON FIRST OPERATION.**
- ! **DO NOT USE AUTOMOTIVE WHEEL CLEANERS OR ANY CLEANING PRODUCTS WHICH CONTAIN ACIDIC ADDITIVES TO CLEAN AKRAPOVIČ EXHAUST SYSTEMS.**

## **WARNING**

Please note that certain aftermarket exhaust systems may not comply with applicable California laws and regulations, and may therefore be prohibited for use on California highways or roads, or on roads or vehicles otherwise subject to emissions control requirements.

Akrapovič exhaust systems for automobiles and motorcycles mounted downstream of the catalytic converter (also known as “cat-back systems”) are considered “replacement parts” in California by the California Air Resources Board (CARB), and do not require an exemption or executive order from CARB to be sold in California. However, California prohibits the use of any aftermarket exhaust system that modifies, removes or replaces original equipment catalysts, unless CARB has issued an Executive Order as to such part or system.

Further, Akrapovič parts or exhaust systems used or intended for use on “racing vehicles” (i.e. a competition vehicle used exclusively for competition on closed-course circuits) do not require an exemption or Executive Order from CARB to be sold in California. However, such parts are prohibited from use on California public highways or roads, even if occasionally used “off-road.”





[www.akrapovic.com](http://www.akrapovic.com)

