



## Installation instructions

Akrapovič Exhaust System:

**Slip-On**

for the

**ABARTH 500**

**ABARTH 500C**

ENGLISH

Version 1.0

03/2016



[www.akrapovic.com](http://www.akrapovic.com)





## Installation instructions

Akrapovič Exhaust System:

**Slip-On**

for the

**ABARTH 500**

**ABARTH 500C**

ENGLISH

Version 1.0

03/2016

[www.akrapovic.com](http://www.akrapovic.com)

Congratulations on purchasing the Akrapovič exhaust system. The Akrapovič exhaust system is a product of Akrapovič d.d., Malo Hudo 8a, 1295 Ivančna Gorica, Slovenia ("Akrapovič").

**Please read this entire installation manual carefully prior to installing and using the Akrapovič exhaust system.**

Akrapovič exhaust system should only be installed by persons skilled in car exhaust system installation and performance. The instructions provided in this manual should be followed to ensure proper installation and safe use of the Akrapovič exhaust system. Akrapovič and/or its partners shall not be held liable for any damage or personal injury (including direct, indirect, or consequential damage) sustained as a result of improper installation of the Akrapovič exhaust system or its use and maintenance contrary to the instructions and warnings contained herein.

If you have any questions regarding the installation and/or proper use of the Akrapovič exhaust system or this manual, please contact your local Akrapovič partner.

For more information on the Akrapovič exhaust systems, see the official Akrapovič website at: <http://www.akrapovic.com>

## **GENERAL INFORMATION**

Your safety is our number one priority. Please drive your car responsibly, safely and always obey local traffic rules.

All statements made with regard to the exhaust system's compliance are made in respect of the exhaust system "as is". Any modifications of the Akrapovič exhaust system or its improper installation, use or maintenance that is not in accordance with this Installation manual, may result in severe damage to the exhaust system and/ or engine, as well as personal injury, and may affect the exhaust system's compliance with the legal requirements, such as exhaust system's air and/ or noise emissions (as an example, the car may not be suitable for use on public roads any longer), as well as warranty coverage.

The exhaust system may only be used in accordance with relevant laws and regulations, including state and federal, where applicable.

Damage caused by improper installation, use and maintenance of the Akrapovič exhaust system is not covered by the Akrapovič warranty. Please refer to the enclosed warranty with regard to the terms of our warranty.

Technical specifications of Akrapovič exhaust systems and related products are subject to change without notice.

## **COPYRIGHT AND OTHER RIGHTS NOTICE**

The Akrapovič trademark, including corporate logos and emblems, are subject to copyright as well as trademark rights of Akrapovič, its licensors, or third persons authorizing Akrapovič to use them.

Any reproduction, technical or other manipulation, translation, or other use of the copyright and/or trademark rights contained herein is prohibited without the explicit prior written consent of Akrapovič. The same especially applies to the entire contents of this manual and/or any of its parts, including but not limited to technical specifications, instructions, graphs, photographs, and so on included in this manual.

Akrapovič takes all copyright and other rights infringement cases under serious consideration. If you have any reason to believe that your exhaust system is not an original Akrapovič product, please contact our local partners or Akrapovič at [info@akrapovic.com](mailto:info@akrapovic.com).

## SAFETY AND COMPLIANCE WARNING, PLEASE READ CAREFULLY

**BEFORE REMOVING THE STOCK EXHAUST SYSTEM AND BEGINNING THE INSTALLATION OF YOUR NEW AKRAPOVIČ EXHAUST, PLEASE MAKE SURE THAT ALL ITEMS LISTED BELOW ARE VERIFIED:**

- This manual is specific to the car indicated on the cover page, for which it is designed. Installation procedures vary depending on the type of car. Please verify that the Akrapovič **exhaust system and this installation manual correspond to the type of your car.**
- The exhaust system can get extremely hot during and after it is used. Make sure not to touch the exhaust system until it is completely cool. **Allow the exhaust and engine to cool down before beginning installation.**
- Make sure the car is **securely positioned to prevent** damage to yourself and other, or the car.
- Please check the parts you received against the parts list available on our website (please use the QR code on the front page or look for “schematic view” in the respective product page on [www.akrapovic.com](http://www.akrapovic.com)). Make sure that you have **all the parts necessary for the installation** of your new Akrapovič exhaust system. If any of the parts is missing, please do not proceed with uninstalling your stock exhaust system/installing the Akrapovič exhaust system and contact the retailer where you purchased the Akrapovič exhaust system.
- Every exhaust system muffler has its unique serial number, which identifies the authenticity of the product. You can find the serial number on the muffler’s sleeve. Please refer to the **picture 1** below. Please verify that your exhaust system is an original Akrapovič product. If you have any doubts, please contact the reseller where you purchased the exhaust system or Akrapovič partners. This manual, any certificates and Akrapovič warranty apply to original products only.

## GENERAL NOTE

Photographs and other illustrations in this manual are symbolic and are intended to help represent individual steps for proper installation and use, as well as for a general overview. The actual component parts of the Akrapovič exhaust system may not entirely correspond to the photographs and other illustrations.

Picture 1 - Serial Number Position

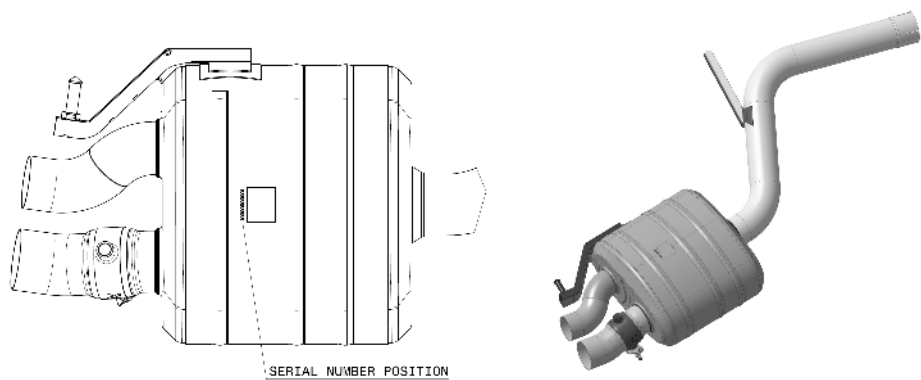

## **NOISE AND EMISSION WARNINGS**

### **General warning**

Because of the world-wide distribution of Akrapovič d.d. products, neither Akrapovič d.d. nor any of its subsidiaries make any representation that the exhaust system complies with the air and/or noise emissions laws, or labeling laws, of any jurisdiction. The purchasers are entirely responsible for informing themselves of the applicable laws where the products are to be used and to comply with those law.

Although legal compliance of Akrapovič products in a specific country should be determined by the user, you can find some basic guidance on compliance of your Akrapovič exhaust system with various legal requirements on the product-related part of our website (please use the QR code on the front page or look for the respective product page on [www.akrapovic.com](http://www.akrapovic.com)). For EC and ECE type approvals, please refer to the certificate enclosed to your product.

### **USA WARNING**

Various U.S. states and the U.S. federal government have individual laws regulating the use of aftermarket exhaust parts and systems, especially as those parts and systems modify, remove, or replace original equipment catalysts. Please consult the appropriate laws in your area before installing any aftermarket part or system on your vehicle to ensure compliance with all applicable laws. Neither Akrapovic d.d. nor any of their subsidiaries or the sellers of the parts or systems make any representation that any of their parts or systems comply with any such laws.

### **CALIFORNIA WARNING**

California laws prohibit the use of any aftermarket exhaust part or system that modifies, removes or replaces original equipment catalysts unless the California Air Resources Board has issued an Executive Order regarding such part or system or unless the part or system is exempted by being used only on racing vehicles on closed courses. Neither Akrapovic d.d. nor any of their subsidiaries make any representation that any of their parts or systems has received such an Executive Order or that any of their parts or systems conform with the racing vehicles exemption. The purchasers are entirely responsible for informing themselves of applicable California laws and to comply with those laws.



## SYMBOLS

The following symbols are used throughout these installation instructions:



**TOOLS AND PROTECTIVE  
EQUIPMENT REQUIRED**



**TIGHTENING TORQUE**



**LUBRICATION**



**HAND TIGHTEN**



**INSTALLATION TIP**



**CAUTION OR IMPORTANT**

### USE BOLT SEALANT

Apply 3 to 4 small drops of bolt sealant onto the cleaned and degreased threads before tightening the bolts.

**WARNING! Avoid contact with skin, eyes and mucous membranes. Do not inhale fumes. Keep out of reach of children.**



### USE ANTI-SEIZE LEAD-FREE COPPER PASTE (black tube)

Provides trouble-free and long-lasting protection against seizing, corrosion and rusting of bolts, threaded ends, nuts, joints, etc. Also protects against vibration, wear and impact. **WARNING! Avoid eye contact. Keep out of reach of children.**



### USE ANTI-SEIZING GREASE (white tube)

Prevents seizing, corrosion and excessive wear between the titanium components of your exhaust system. **WARNING! Avoid eye contact. Keep out of reach of children.**



## Tools & equipment

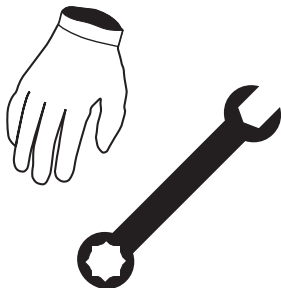

- Hexagon socket 13mm
- Hexagon socket 15mm
- Hexagon socket 17mm
- T-handle swiveling 10mm wrench
- T-handle 7mm wrench
- Cutting nippers
- Pry bar

## PARTS LIST

The following parts should be found in the box:

- Installation Manual
- Homologation certificate/ compliance documents if applicable
- Warranty
- Fitting material
- Muffler and pipes

Detailed list of parts can be found on the Akrapovič website (please use the QR code on the front page or look for “Schematic view” in the respective product page on [www.akrapovic.com](http://www.akrapovic.com)).

**IMPORTANT: The car should be in the off position throughout the dismantling and installation process, as well as any other work done on the exhaust system!**

## **REMOVAL OF STOCK EXHAUST SYSTEM:**

The process of uninstalling the original exhaust system may vary depending on the existing exhaust system. Please follow the original exhaust system manufacturer's instructions for uninstalling the original exhaust system.

If you for any reason decide otherwise, please note that any information provided in this respect herein should be considered as general information provided for your convenience only. Akrapovič shall not assume any liability or responsibility with regard to uninstalling your existing exhaust system, warranty coverage of such exhaust system or vehicle or their further fitness for use.

**In case your Akrapovič exhaust system may not be used on certain roads or under certain conditions, please keep the stock or other exhaust system that you can use in such circumstances legally.**

## REMOVAL OF ORIGINAL EXHAUST SYSTEM:

Put the vehicle onto a car lift.

**!** **CAUTION:** ensure that the car is lifted safely and properly in order to avoid the risk of vehicle damage, injury, or even death!

1. Untighten the marked original clamp (Figure 1).



Figure 1

2. Carefully pull the rubber brackets off the muffler's brackets, using flat pry bar and remove the original muffler off the vehicle (**Figure 2, 3**).

**✂** **INSTALLATION TIP:** for easier dismounting, disassemble the rear wheels.

**✂** **INSTALLATION TIP:** for easier dismounting, lubricate the original rubber brackets (WD40®)\*.

**!** **CAUTION:** make sure, that you support the original muffler during this process or you could injure yourself or damage the vehicle!

\*WD-40® is a trademark of the WD-40 Company.



**Figure 2**

**!** **IMPORTANT:** make sure, not to damage the rubber brackets or any other part of the vehicle during this process!

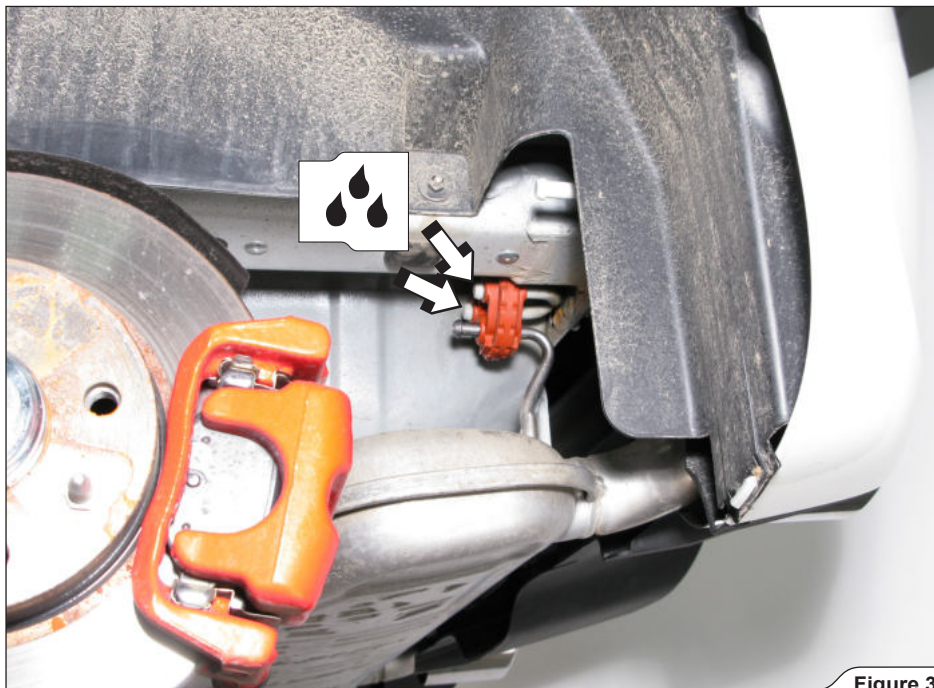

**Figure 3**

## INSTALLATION OF THE AKRAPOVIČ EXHAUST SYSTEM:

1. Assemble the clamps and link pipe onto the muffler's inlet pipes and original left rubber bracket onto the Akrapovič muffler's left bracket, as shown (Figure 4).

! **IMPORTANT:** use anti-seize copper paste on all clamps' bolt threads!

! **IMPORTANT:** in case you choose to grind off the spot welds and brake the link pipe's seal off, the Akrapovič exhaust system EC Type approval is not valid!

 **INSTALLATION TIP:** for easier mounting, lubricate the original rubber bracket (WD40®)\*.

\*WD-40® is a trademark of the WD-40 Company.

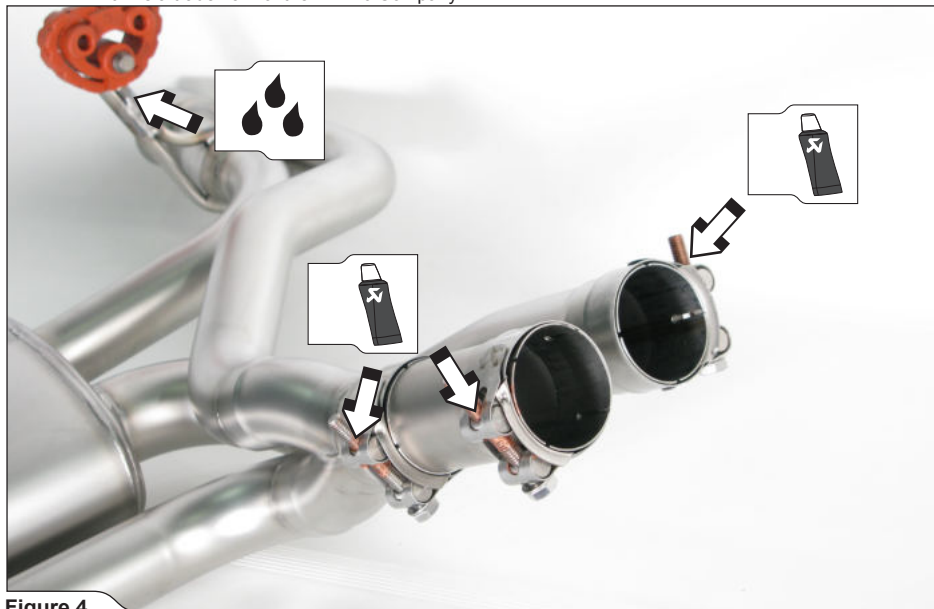

Figure 4

2. **For optional wireless kit only:** assemble the clamps and link pipe with exhaust valve onto the muffler's inlet pipes and original left rubber bracket onto the Akrapovič muffler's left bracket, as shown (Figure 5).

**!** **IMPORTANT:** use anti-seize copper paste on all clamps' bolt threads!

**✂** **INSTALLATION TIP:** for easier mounting, lubricate the original rubber bracket (WD40®)\*.

\*WD-40® is a trademark of the WD-40 Company.

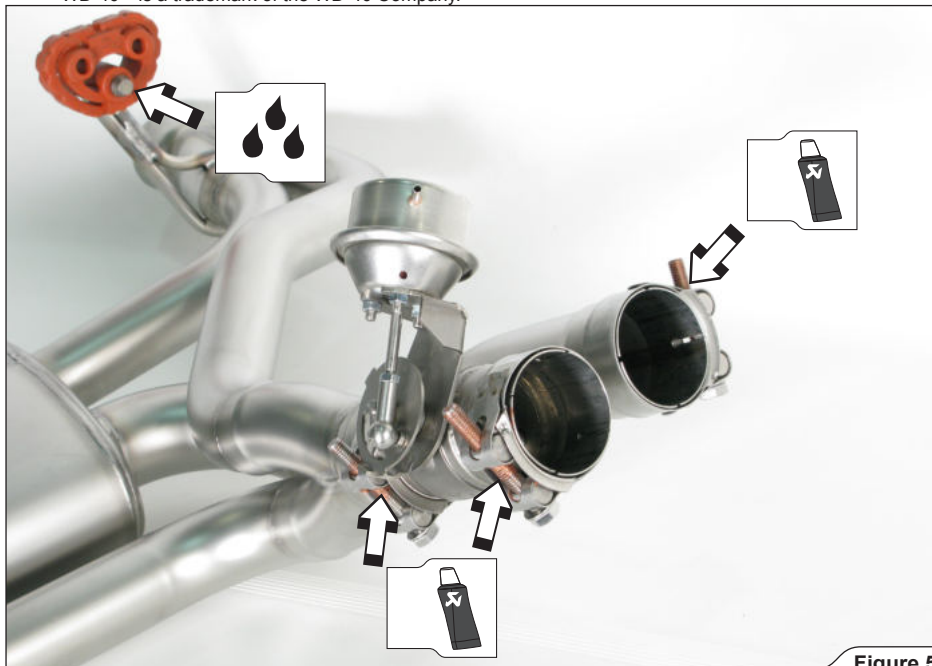

Figure 5



3. Fully unscrew the clamp's nut and assemble it onto the collector. Position the clamp exactly as shown (Figure 6).

**!** **IMPORTANT:** use anti-seize copper paste on clamps' bolt and nut threads!



Figure 6

- Slide the collector onto the original pipe and hand tighten the clamp (**Figure 7**).
- ! IMPORTANT: do not fully tighten the clamp yet!**

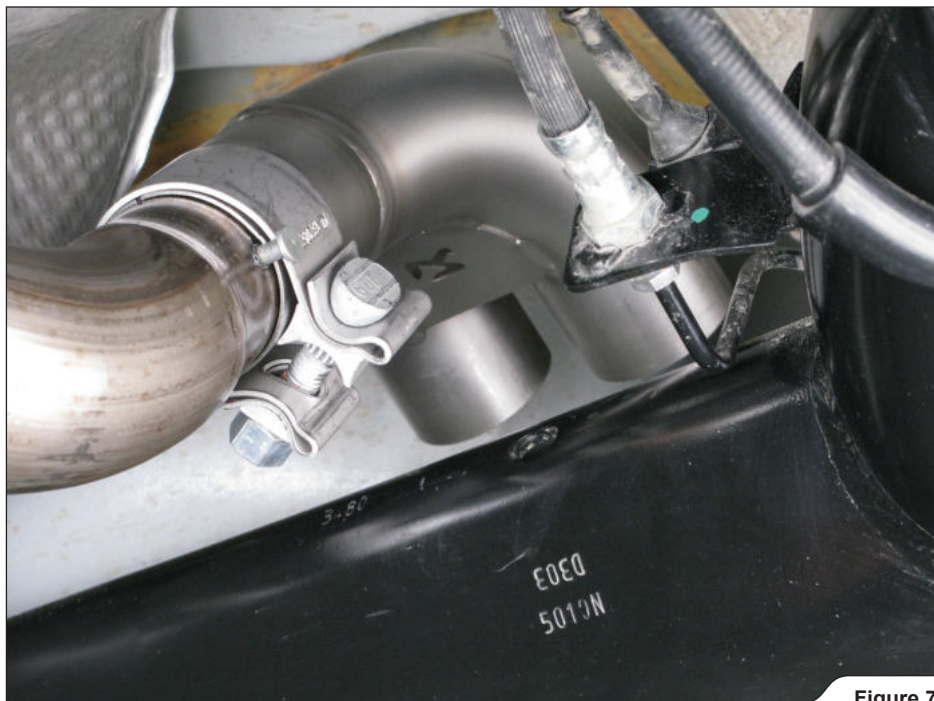

**Figure 7**

5. Carefully re-form the original aluminium heat shield as shown (Figure 8, 9).
- ! **IMPORTANT:** make sure not to crack or in any other way damage the heat shield!

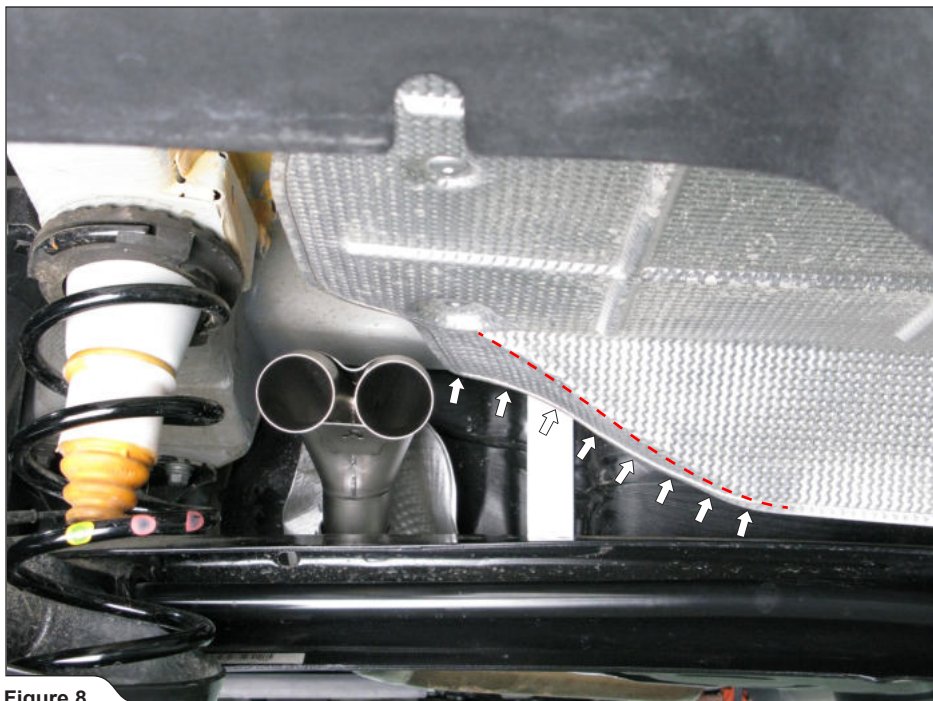

Figure 8



Figure 9

6. Slide the muffler onto the collector and hang the muffler onto the original rubber brackets. Center the muffler in respect to the rear bumper's tail pipe outlets (**Figure 10**).

**✚** **INSTALLATION TIP:** for easier mounting, lubricate the original rubber brackets (WD40®)\*.

**!** **CAUTION:** make sure, that you support the muffler during this process or you could injure yourself or damage the vehicle!

\*WD-40® is a trademark of the WD-40 Company.

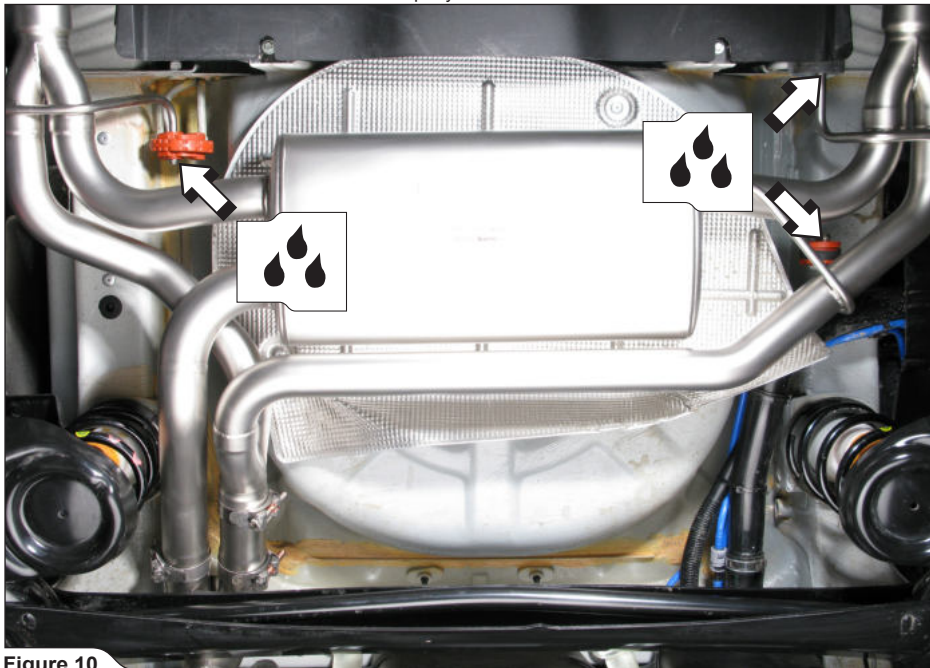

**Figure 10**

7. **For optional wireless kit only:** rotate the link pipe with exhaust valve and orient the clamps as shown (Figure 11).
- !** **IMPORTANT:** make sure, that exhaust valve doesn't touch any part of the exhaust system or the vehicle chassis!

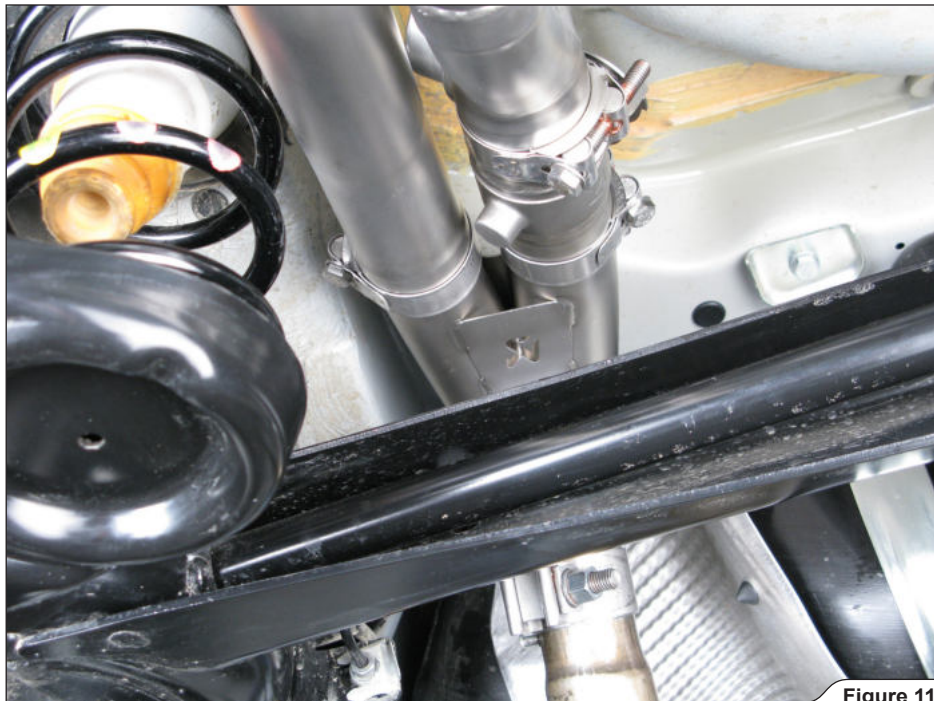
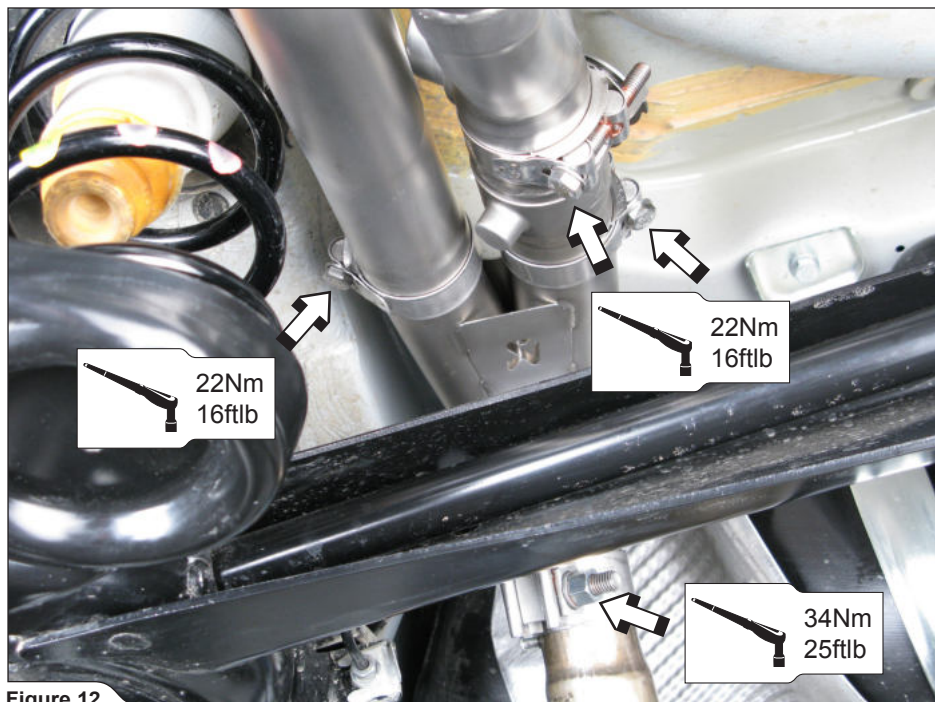

Figure 11



8. For optional wireless kit only: tighten the clamps to the specified torques (**Figure 12**).



**Figure 12**

9. Orient the clamps as shown and tighten them to the specified torques (**Figure 13**).

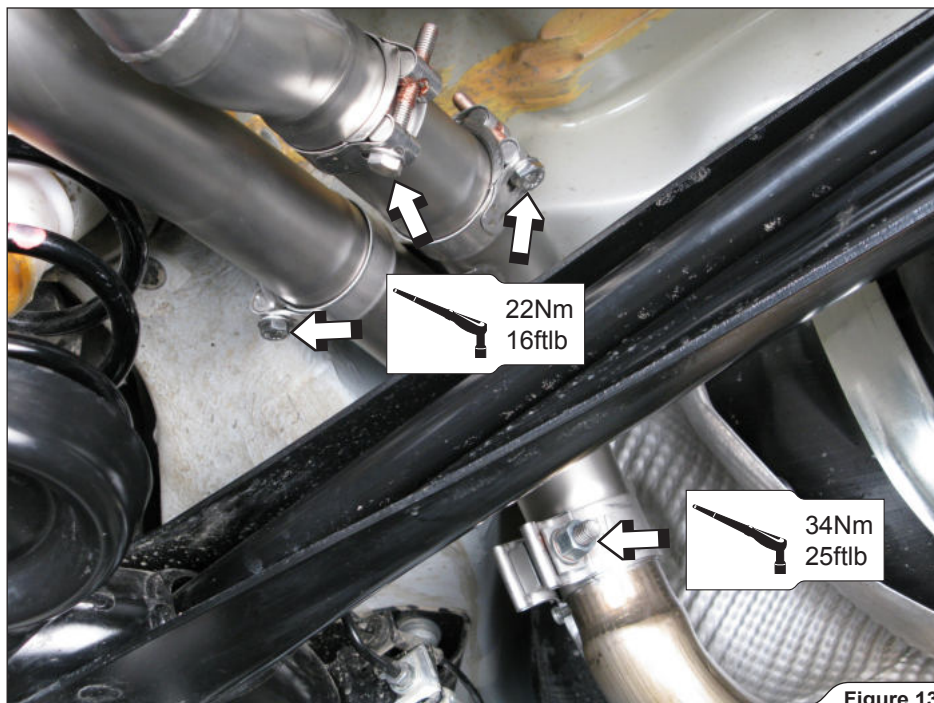

**Figure 13**



10. Assemble the clamps and spherical rings onto the tail pipes, as shown (Figure 14).

! **IMPORTANT:** use anti-seize copper paste on clamp bolt threads!



Figure 14

11. Slide the tail-pipes onto the muffler outlets. Rotate and center them in respect to rear bumper and according to your personal taste (**Figure 15**).

**!** **IMPORTANT:** in case the tail pipes can't be centered in respect to the bumper's outlets, repeat the adjustment of original pipe-middle pipe-muffler inlet pipes joints (**Figure 11**).



**Figure 15**

12. Tighten tail pipe clamps to the specified torque on both sides and assemble the rear wheels back onto the vehicle (**Figure 16**).

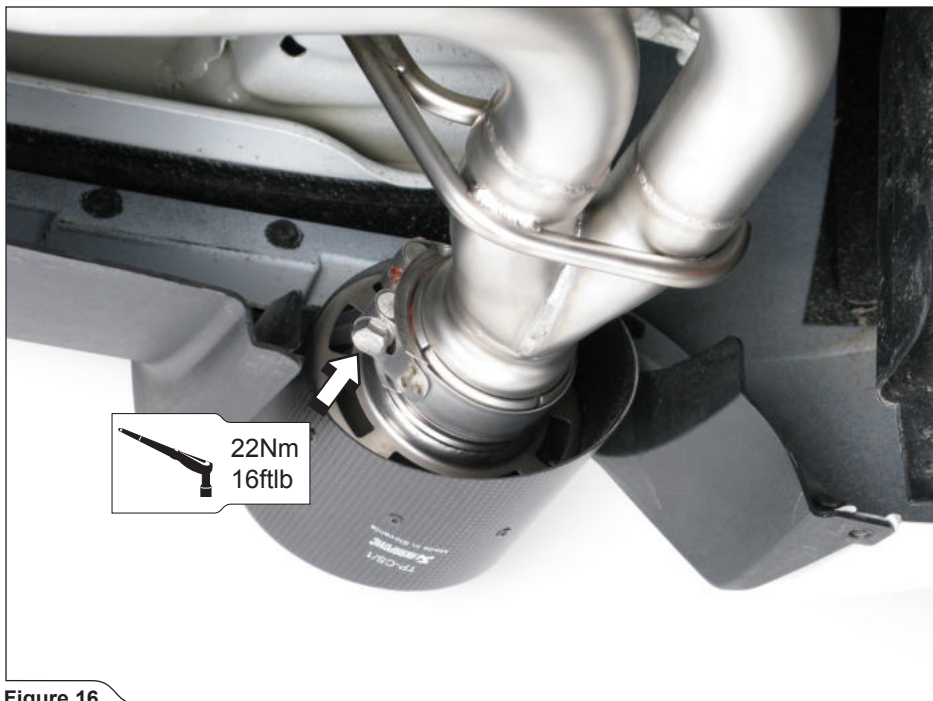

**Figure 16**

13. **For optional wireless kit only:** unscrew the marked bolts and remove the engine cover (Figure 17).



Figure 17

14. For optional wireless kit only: remove both fuse box covers (Figure 18).  
! **IMPORTANT:** make sure not to damage any part of the vehicle during this process!



Figure 18

15. For optional wireless kit only: remove the marked 7.5A fuse from F16 fuse spot (Figure 19).

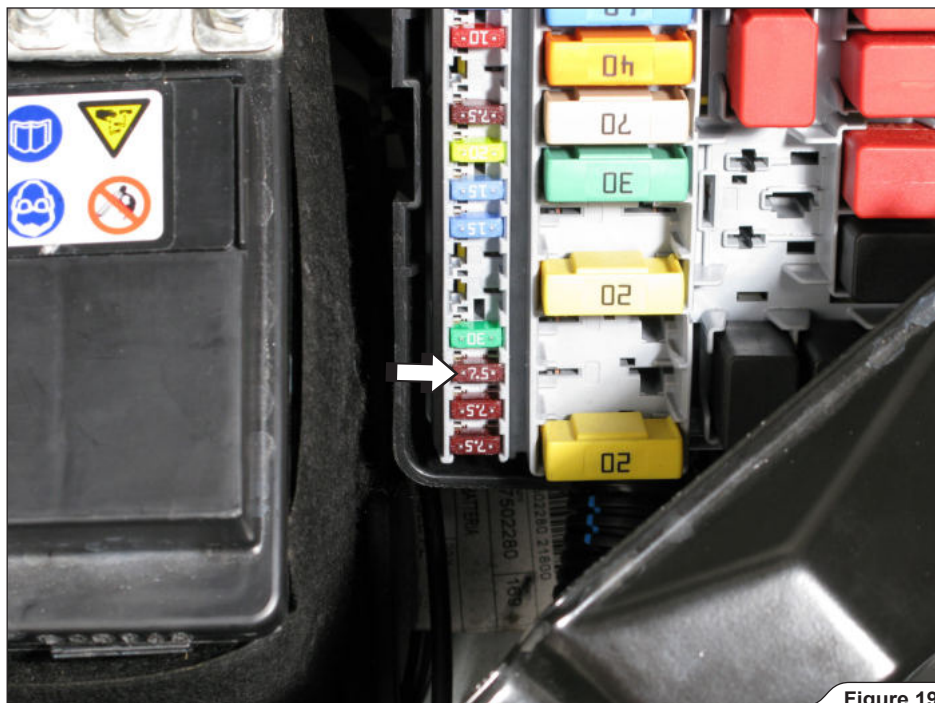

Figure 19

16. **For optional wireless kit only:** insert the 7.5A fuse into the transmitter's fuse connector (Figure 20).

**!** **IMPORTANT:** in case of broken supplied fuse, use only automotive 2A and 7.5A small-blade fuses (Figure 20)!

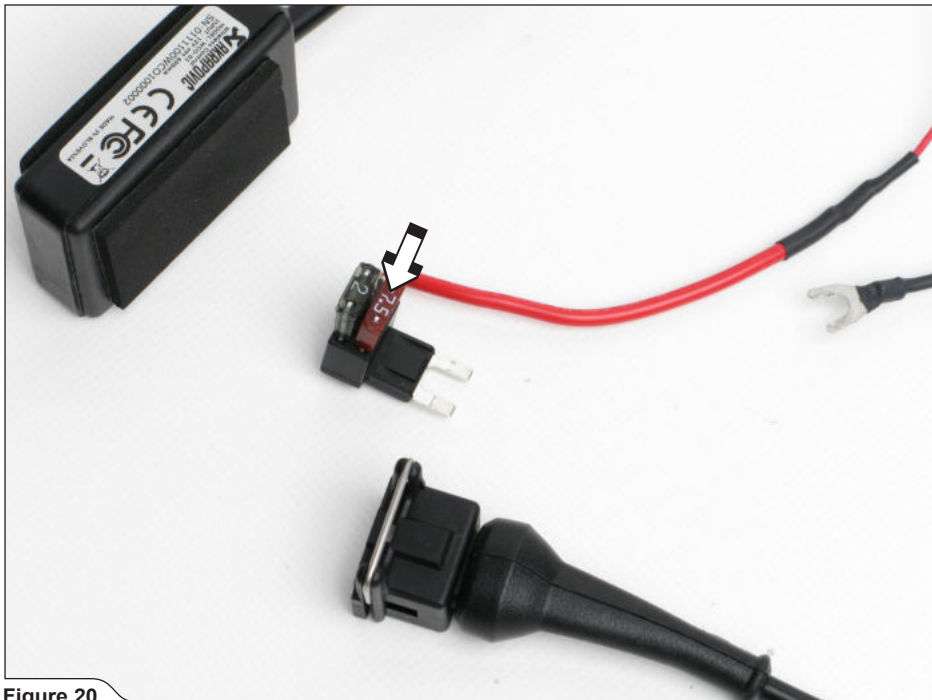

Figure 20



17. **For optional wireless kit only:** insert the transmitter's fuse connector into the F16 fuse spot, tuck the transmitter into the fuse box, tighten the ground connector (black thin wire) to the negative pole of the battery and secure the wires using tie wraps, as shown (**Figure 21**).

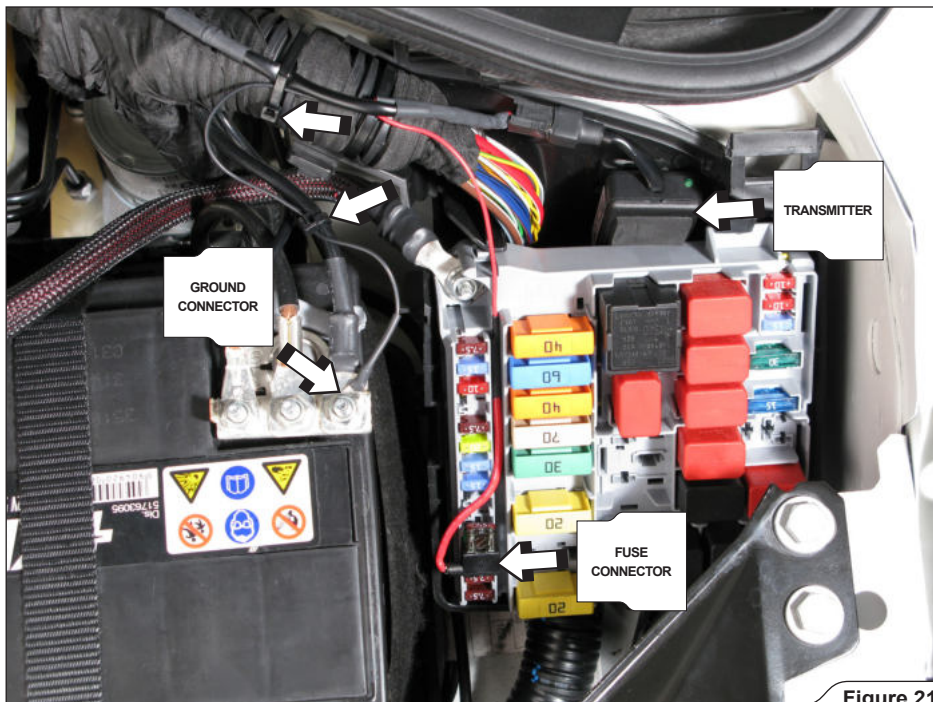

Figure 21



18. **For optional wireless kit only:** carefully pull the marked vacuum tube off the vacuum distributor (Figure 22).

! **IMPORTANT:** make sure not to damage any part of the vehicle during this process!

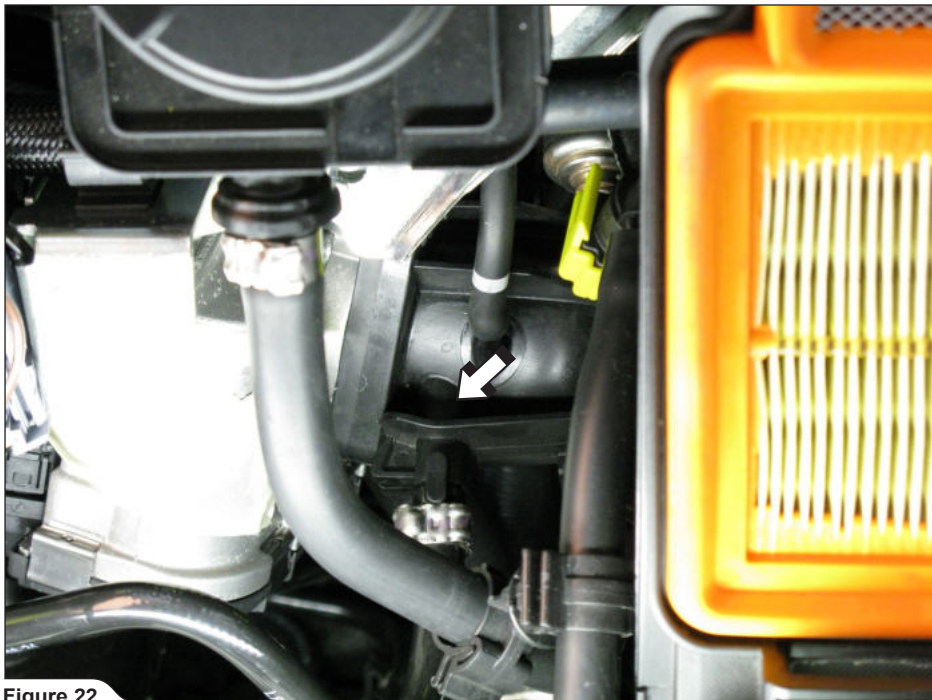

Figure 22

19. **For optional wireless kit only:** instal the Akrapovič electromagnetic valve assembly between the original vacuum tube and vacuum distributor, as shown (**Figure 23, 24**).



**Figure 23**

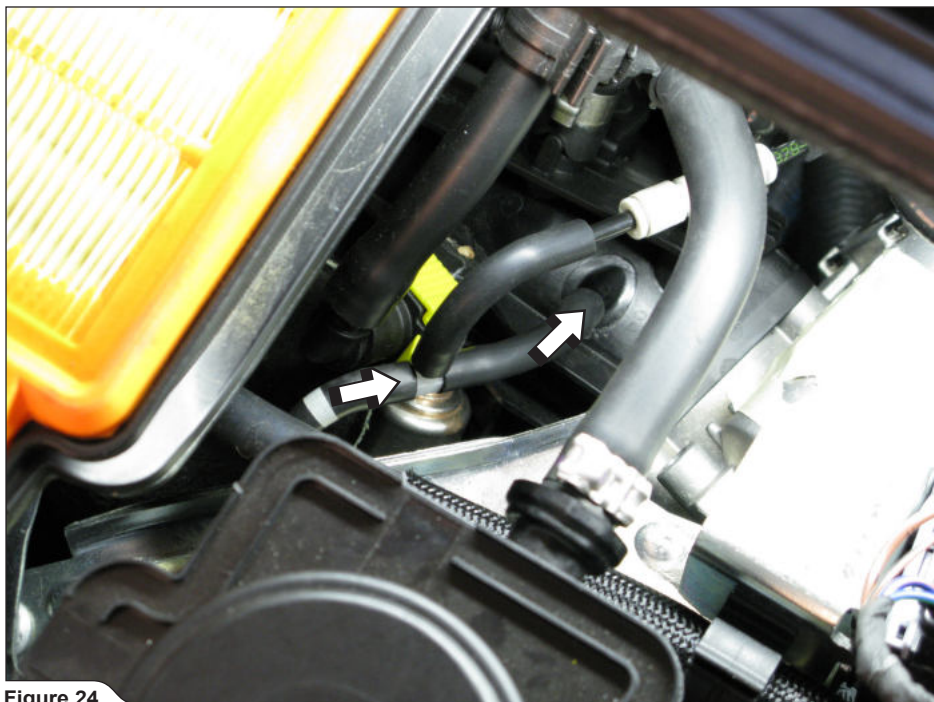
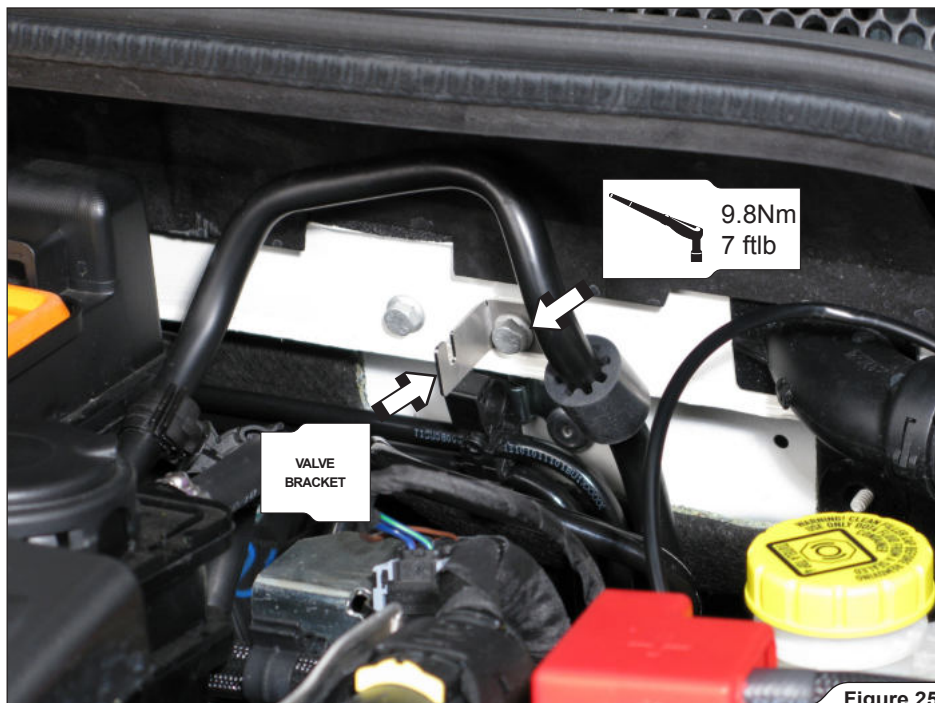
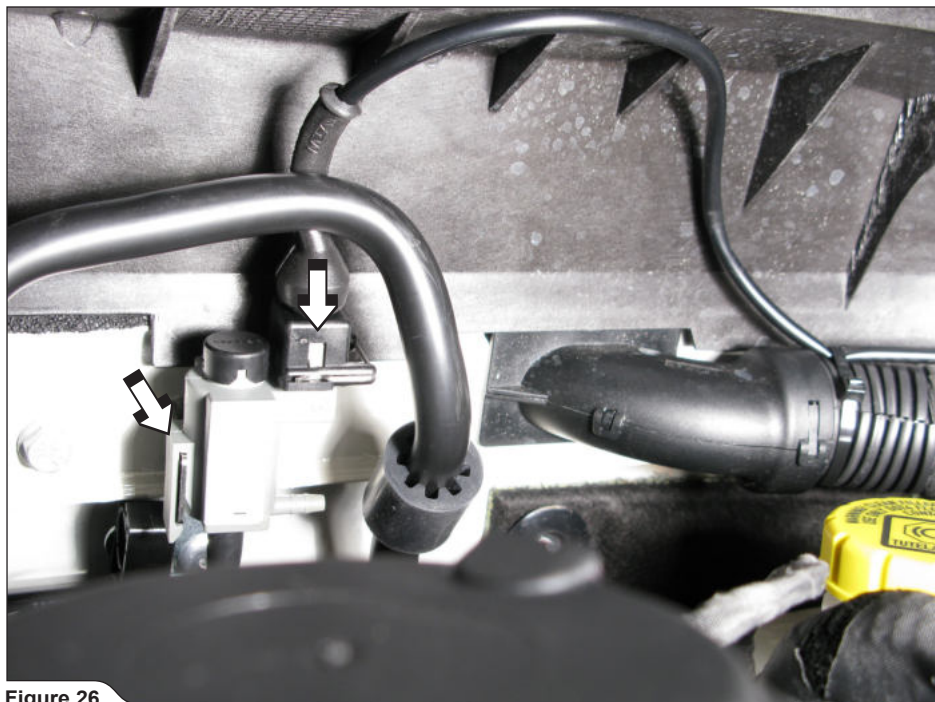

Figure 24

20. **For optional wireless kit only:** screw the electromagnetic valve's bracket onto the chassis, using marked original bolt (**Figure 25**).



21. **For optional wireless kit only:** clip the electromagnetic valve onto the bracket and plug the transmitter's connector onto the valve (**Figure 26**).



**Figure 26**

22. **For optional wireless kit only:** grind the lower fuse box cover as shown (**Figure 27**).



**Figure 27**

23. For optional wireless kit only: assemble both covers back onto the fuse box (Figure 28).
- ! **IMPORTANT:** make sure not to damage any part of the vehicle or transmitter during this process!



Figure 28



24. For optional wireless kit only: reinstall the engine cover (Figure 29).

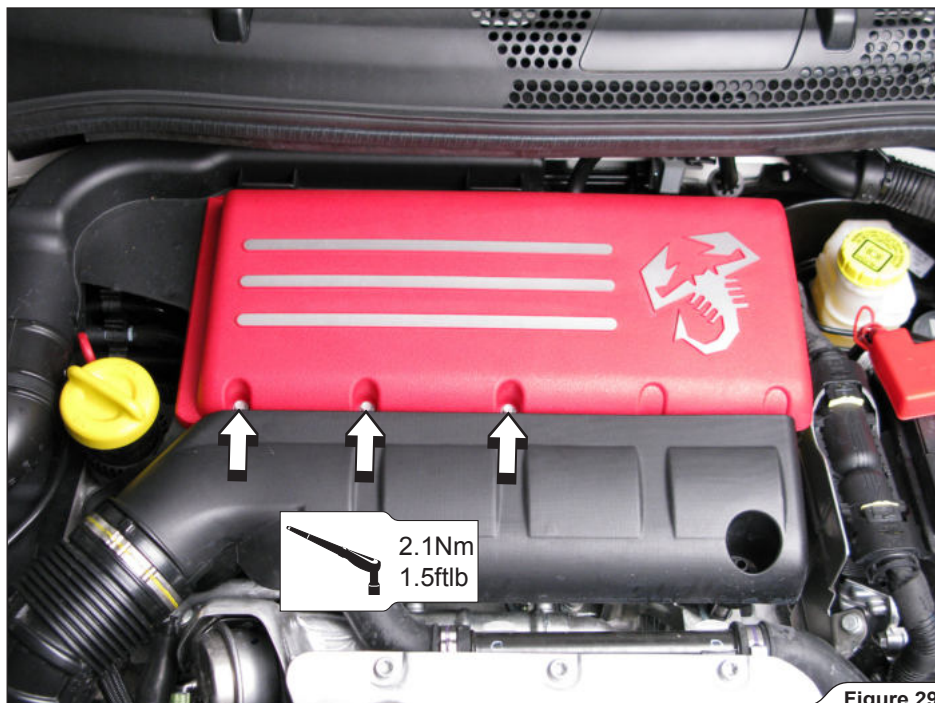



25. **For optional wireless kit only:** unscrew the marked bolts and nut. Remove the installations protection off the vehicle (**Figure 30**).

**!** **IMPORTANT:** make sure not to damage any part of the vehicle during this process!

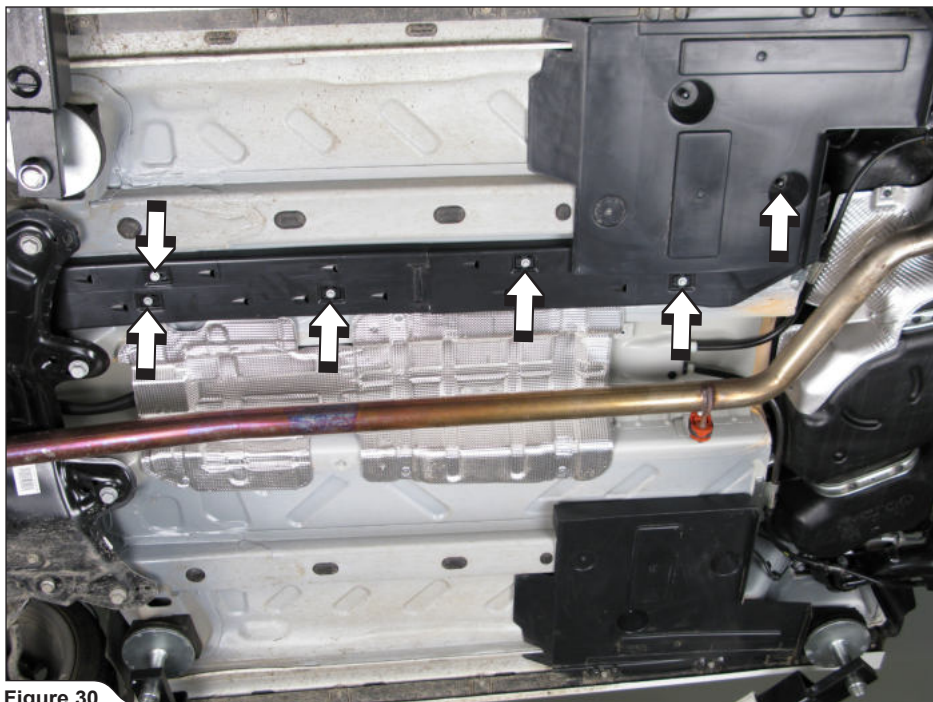

Figure 30

26. For optional wireless kit only: undo the two marked heat shield's clips (Figure 31).

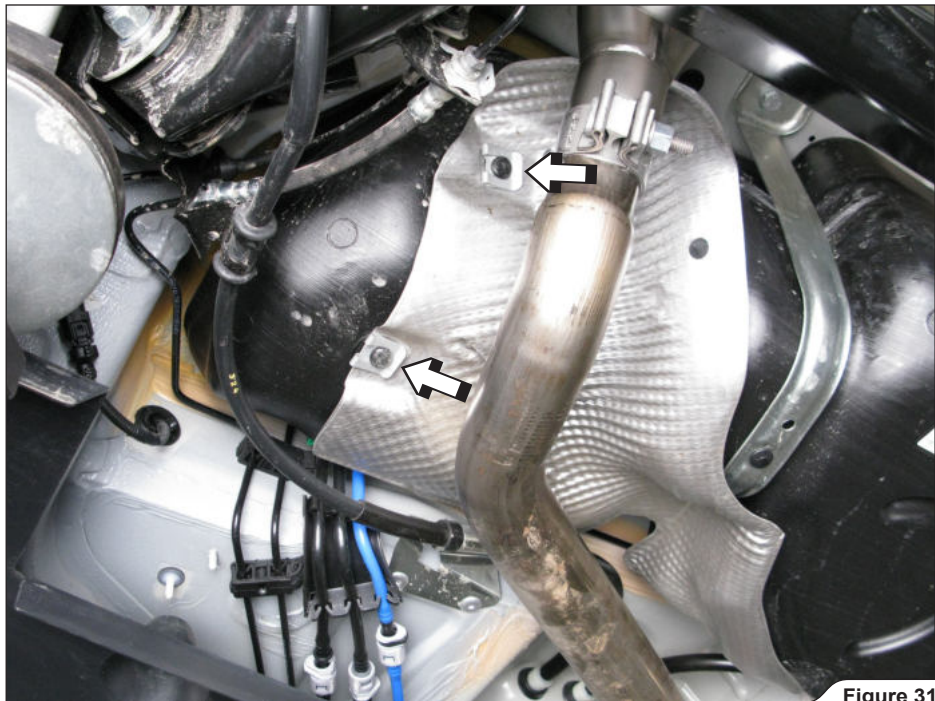

Figure 31

27. **For optional wireless kit only:** connect the Akrapovič rubber vacuum hose to the vacuum actuator and direct the hose to the electromagnetic valve in the engine compartment, as shown (Figure 32, 33, 34, 35, 36).

! **IMPORTANT:** direct the rubber vacuum hose in such a way, that it doesn't touch any hot or moving parts of the vehicle!

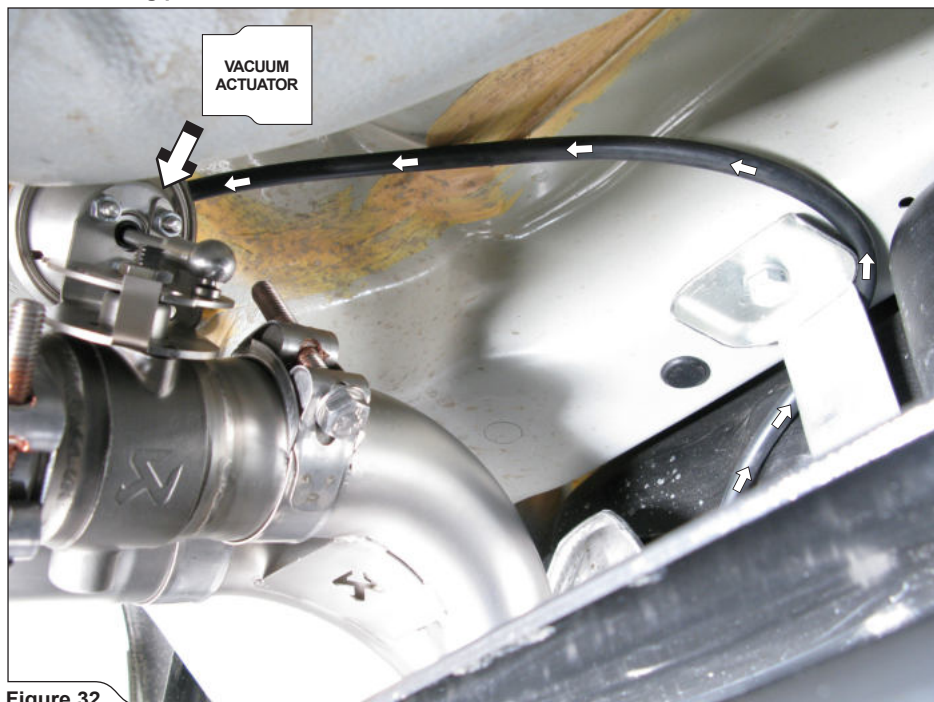

Figure 32

! **IMPORTANT:** direct the vacuum hose between fuel tank and heat shield (Figure 33)!



Figure 33

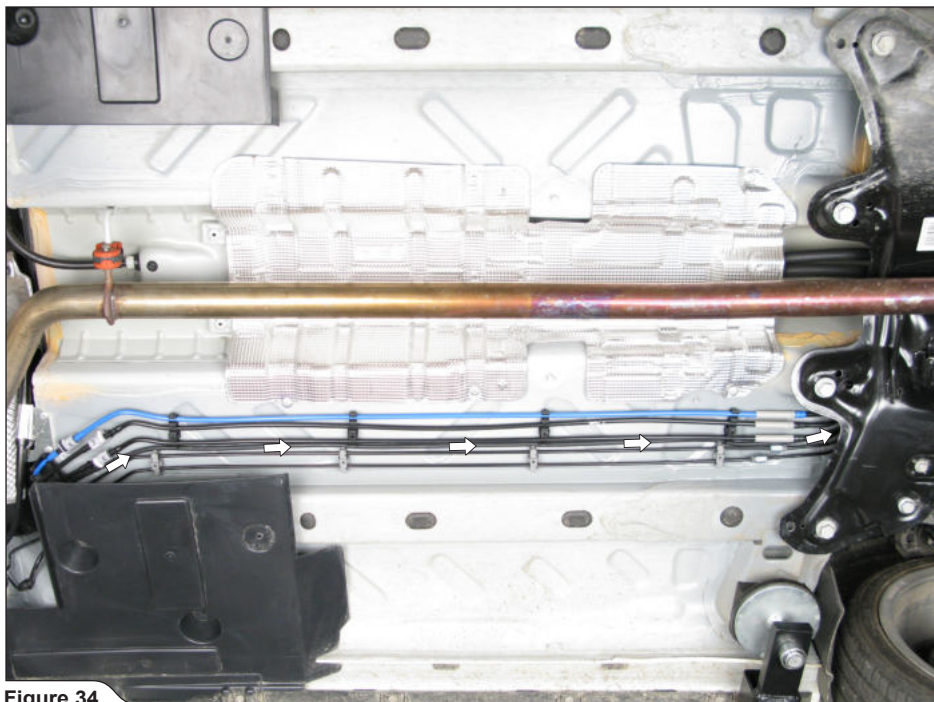

Figure 34



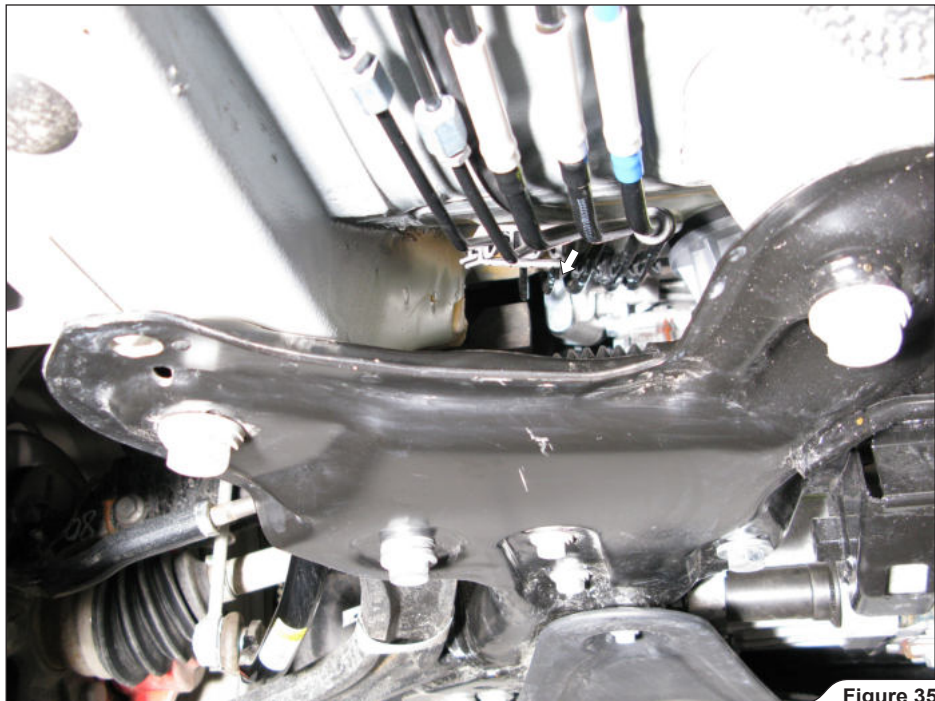

Figure 35

! **IMPORTANT:** secure (use additional plastic tie wrap) the rubber vacuum hose, as shown (Figure 36)!



Figure 36

28. **For optional wireless kit only:** reinstall the heat shield's clips and the installations protection (Figure 37, 38).

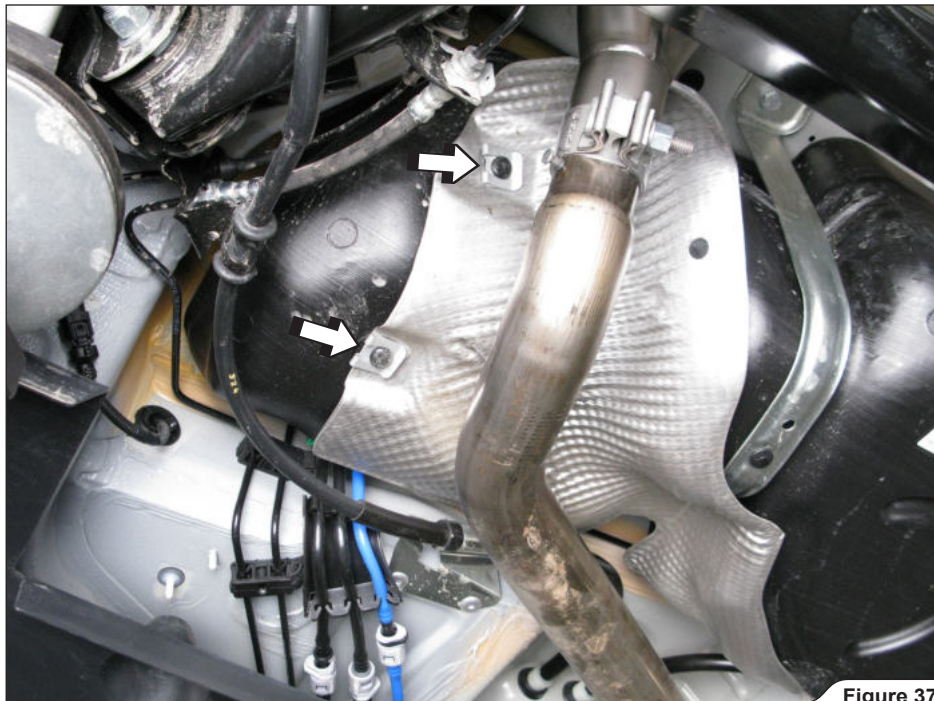

Figure 37



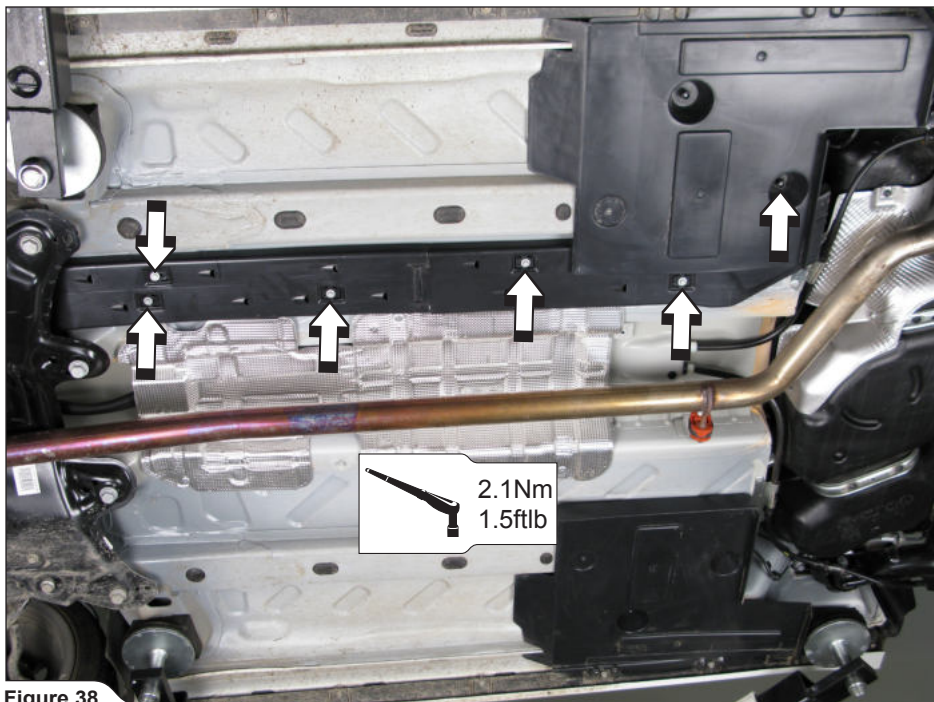

Figure 38

! **IMPORTANT:** secure all vacuum tubing connections, using clamps from Akrapovič installation kit! Install the clamps with corresponding tube clamp pliers (Figure 39).



Figure 39

[EMPTY PAGE]

## FINAL INSTALLATION:

- ! **IMPORTANT:** reinstall the dismantled or partially removed stock parts (wheel arches, bumper etc.); check vehicle manufacturer manual for tightening torques.
- ! **IMPORTANT:** make sure all the nuts and bolts are sufficiently tightened. In case the exhaust system touches the cowling or other parts, repeat the adjustment of the exhaust system or contact your authorized dealer.
- ! **IMPORTANT:** clean all exhaust components before the first start of the engine or the stains will burn onto the surfaces!

## MAINTENANCE OF THE AKRAPOVIČ EXHAUST SYSTEM:

1. Clean the titanium exhaust components with a multi-purpose spray lubricant (WD-40<sup>®</sup> or equivalent)\*, carbon fiber exhaust components with soft and dry cloth and stainless steel components with soft cloth sprayed with contact cleaner, then wipe with soft and dry cloth. A change in the color of the exhaust system is normal due to high temperatures.
2. Periodically make sure all the bolts and springs are sufficiently tight.  
\*WD-40<sup>®</sup> is a trademark of the WD-40 Company.



**INSTALLATION TIP: IT IS NORMAL FOR WHITE SMOKE TO COME OUT OF THE MUFFLER AT FIRST OPERATION.**

- ! **CAUTION: DO NOT STAND BEHIND THE MUFFLER AT ANY TIME.**
- ! **CAUTION: DO NOT USE AUTOMOTIVE WHEEL CLEANERS OR ANY CLEANING PRODUCTS WHICH CONTAIN ACIDIC ADDITIVES TO CLEAN THE AKRAPOVIČ EXHAUST SYSTEMS.**

**WARNING: THE EXHAUST SYSTEM CAN BE EXTREMELY HOT. ALLOW THE EXHAUST AND ENGINE TO COOL DOWN BEFORE BEGINNING INSTALLATION OR ANY OTHER WORK ON THE EXHAUST SYSTEM. THIS MANUAL IS SPECIFIC TO THE ABARTH 500. THERE MAY BE SOME DIFFERENCES IN INSTALLATION PROCEDURES FOR OTHER MODELS.**

## TROUBLESHOOTING:

| Problem   | Possible cause                      | Solution  |
|---|-------------------------------------|---|
| Exhaust gas leaks out of the muffler/pipe clamp connections | loosened clamp                      | tighten the clamp to specified torque   |
|   | connection is not completely joined | tap the connection into place and tighten the clamp to specified torque   |
| Valves are not moving                                       | No supply                           | Check green LED on the Control Kit.<br>If the LED is off: <ul style="list-style-type: none"><li>• Check electrical connection and connectors</li><li>• Check fuse for exhaust valves (in the trunk, right)</li></ul>  |
|   | Error detected                      | Check green LED on the Control Kit.<br>If the LED is blinking fast: <ul style="list-style-type: none"><li>• Check electrical connections and connectors</li><li>• Try to use the Sound Kit remote controller. If valves are turning, then check how the Communication sensor is installed</li></ul> |

**[EMPTY PAGE]**

[EMPTY PAGE]

[www.akrapovic.com](http://www.akrapovic.com)

