



Installation instructions

Akrapovič Exhaust Systems:
Slip-On and Slip-On with optional Link Pipes
for the
Ferrari 458 Italia

WARNING

Please note that certain aftermarket exhaust systems may not comply with applicable California laws and regulations, and may therefore be prohibited for use on California highways or roads, or on roads or vehicles otherwise subject to emissions control requirements.

Akrapovič exhaust systems for automobiles and motorcycles mounted downstream of the catalytic converter (also known as “cat-back systems”) are considered “replacement parts” in California by the California Air Resources Board (CARB), and do not require an exemption or executive order from CARB to be sold in California. However, California prohibits the use of any aftermarket exhaust system that modifies, removes or replaces original equipment catalysts, unless CARB has issued an Executive Order as to such part or system.

Further, Akrapovič parts or exhaust systems used or intended for use on “racing vehicles” (i.e. a competition vehicle used exclusively for competition on closed-course circuits) do not require an exemption or Executive Order from CARB to be sold in California. However, such parts are prohibited from use on California public highways or roads, even if occasionally used “off-road.”



Installation instructions

Akrapovič Exhaust Systems:
Slip-On and Slip-On with optional Link Pipes
for the
Ferrari 458 Italia

Congratulations on purchasing an Akrapovič exhaust system. Please read the entire installation manual prior to undertaking any activities related to installation of your new Akrapovič exhaust system. In case you do not fully understand the manual or any of its parts, please contact your authorized dealer!

This product should be installed by someone with sufficient knowledge of exhaust systems and their installation, and appropriate hand or power tools. If you are not qualified for this work, please utilize a certified mechanic for installation. By installing Your Akrapovič exhaust system, you indicate that you have read the installation manual in its entirety and you agree with the terms stated herein.

It is your responsibility to follow all installation instruction guidelines supplied with the Akrapovič exhaust system and undertake all necessary safety precautions. Akrapovič d.d. assumes no responsibility for damages occurring from misuse, abuse, improper installation, improper operation, lack of responsible care, or all previously stated reasons resulting from incompatibility with other manufacturer's products and/or systems.

IMPORTANT INFORMATION

Exclusion of Certain Liability

1. The manufacturer, importer or dealer shall not be liable for any incidental damage including personal injury or any other damages caused by improper installation or operation of the Akrapovič exhaust system. When installing the Akrapovič exhaust system be careful that the exhaust system does not touch other parts sensitive to high temperature.
2. Akrapovič makes no representation or warranties with regard to damage caused by the improper installation, use and maintenance of the Akrapovič exhaust system. The warranty is limited to defects recognized by our technical department and due to normal use, and excludes items subject to normal wear (gaskets and damping wool). The guarantee is void in case of accident, modification, improper or competition use.
3. Do not attempt to install the Akrapovič exhaust system on a vehicle model for which it was not made or tested by Akrapovič.
4. When the exhaust system gets very hot during operation, be careful not to burn yourself on the exhaust system or parts which are in direct contact with it, even when the engine is not running. Also protect other people, especially children, from the injuries mentioned above.

1. In some cases Akrapovič exhaust system kits contain chemical products (ceramic anti-seizing grease; bolt sealant). Handle with care, do not inhale or swallow. Avoid excessive contact with skin, eyes or mucous membranes. Keep out of reach of children.
2. Technical specifications of Akrapovič exhaust systems and related products are subject to change without notice.
3. Before removing the original exhaust system from your vehicle, please compare the parts you received with the list of materials provided in the installation manual in order to assure that you have all the parts necessary for the installation of your new Akrapovič exhaust system.
4. Although this manual consists of instructions for installation in written form, as well as photographs and pictures representing individual steps of the installation, please note that the photographs and pictures are symbolic and are intended for representation of general overview only. The photographs and pictures contained herein should serve as a guideline only and actual installation of the exhaust system may not correspond with the photographs and pictures entirely.
5. The process of uninstalling the original exhaust system may vary depending on the existing exhaust system. Please follow the original exhaust system manufacturer's instructions for uninstalling the original exhaust system.

Trademarks

The Akrapovič Exhaust System Technology logo is a registered trademark of Akrapovič d.d.

Akrapovič website

Information about Akrapovič exhaust systems and related products is available on the Akrapovič website at:

<http://www.akrapovic.com/>

Copyright

No part of the Akrapovič exhaust system or its documentation may be reproduced or distributed in any form or by any means without the prior written authorization of the Akrapovič company.

© Akrapovič, d.d. All rights reserved.

Symbols

The following symbols are used throughout these installation instructions:



TOOLS REQUIRED



TIGHTENING TORQUE



INSTALLATION TIP



CAUTION OR WARNING



USE BOLT SEALANT; Apply 3 to 4 small drops of bolt sealant onto the cleaned and degreased threads before tightening the bolts. **WARNING! Avoid contact with skin, eyes and mucous membranes. Do not inhale fumes. Keep out of the reach of children.**



USE ANTI-SEIZE LEAD-FREE COPPER PASTE (black tube); Provides trouble-free and long-lasting protection against seizing, corrosion and rusting of bolts, threaded ends, nuts, joints, etc. Also protects against vibration, wear and impact. **WARNING! Avoid eye contact. Avoid excessive skin contact. Keep out of reach of children.**



USE ANTI-SEIZING GREASE (white tube); Prevents seizing, corrosion and excessive wear between the titanium components of your exhaust system. **WARNING! Avoid eye contact. Avoid excessive skin contact. Keep out of reach of children.**



Hexagon key 3mm wrench
Hexagon key 4mm wrench
T-handle 10mm wrench
T-handle 13mm wrench
Combination 10mm wrench
Combination 22mm wrench
Torx 30 wrench
Torx 40 wrench
Bi-hex 15 socket
Needle knurled nose pliers
Cross head screwdriver
Utility knife



BEFORE INSTALLING, CHECK THE SCHEMATIC OF THE EXHAUST SYSTEM!



IF ANY ITEMS IN THE AKRAPOVIČ EXHAUST SYSTEM PACKAGE ARE MISSING, PLEASE CONTACT YOUR AUTHORIZED DEALER. KEEP THE SCHEMATIC FOR FUTURE REFERENCE.



THESE INSTALLATION INSTRUCTIONS MUST BE READ CAREFULLY IN ORDER TO ENSURE PROPER INSTALLATION AND OPERATION OF THE AKRAPOVIČ EXHAUST SYSTEM.



THE EXHAUST SYSTEM CAN BE EXTREMELY HOT. ALLOW THE EXHAUST AND ENGINE TO COOL DOWN BEFORE BEGINNING INSTALLATION.



WE ADVISE YOU TO LEAVE INSTALLATION TO A QUALIFIED SERVICEMAN. IMPROPER INSTALLATION MAY RESULT IN A SHORTER LIFETIME OF THE EXHAUST SYSTEM AND/OR DAMAGE TO THE VEHICLE.



WHEN INSTALLING AN AFTERMARKET AKRAPOVIČ OPTIONAL LINK PIPES, WHICH ARE DEVELOPED FOR USE ON CLOSED TRACK, WE RECOMMEND REMAPPING OF THE ECU TO PREVENT POSSIBLE “ENGINE CHECK LIGHT” WARNING SIGNAL.

REMOVAL OF ORIGINAL EXHAUST SYSTEM:

Put the vehicle onto a car lift.

! **WARNING:** make sure, that car lifting is safely and correctly done, or you risk vehicle damage, injury or even death!

1. **For Slip-On and optional Link Pipes:** unscrew and remove rear wheel and wheel arch panels on both sides of the vehicle (Figure 1, 2).



Figure 1

! **WARNING:** make sure, not to damage yourself or any part of the vehicle during this process!

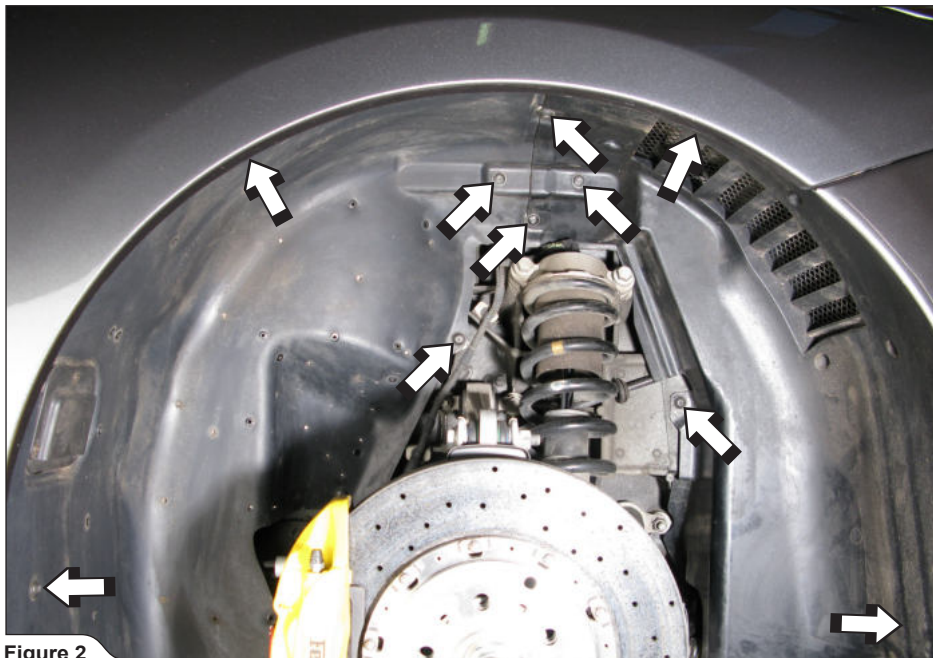

Figure 2

2. **For Slip-On and optional Link Pipes:** unscrew the marked bolts and remove the diffuser off the vehicle (**Figure 3**).

! **WARNING:** make sure, not to damage yourself or any part of the vehicle during this process! Use personal protection equipment!



Figure 3

3. **For Slip-On and optional Link Pipes:** disconnect the number plate lights/PDC sensors/fog lights connector. Pull the grey safety pin out first, then press the black pin in and pull the connector apart (**Figure 4**).

! CAUTION: be careful not to damage the electrical connector, bumper or any other part of the car during this process!



Figure 4

4. **For Slip-On and optional Link Pipes:** unscrew the marked rear bumper's bolts on both sides of the vehicle (**Figure 5**).

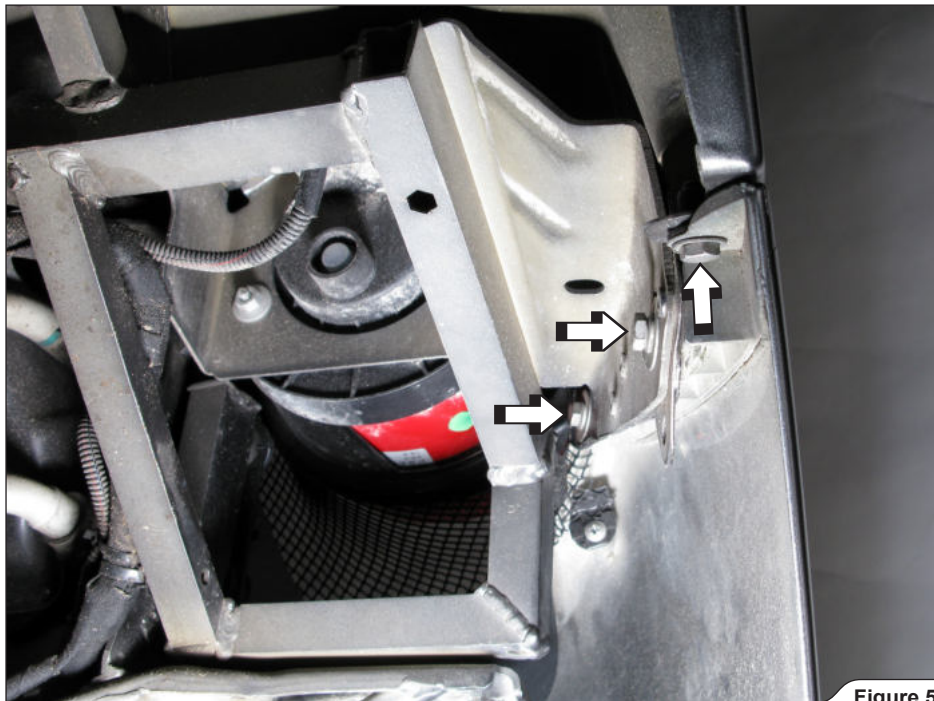

Figure 5

5. For Slip-On and optional Link Pipes: carefully remove the rear bumper off the vehicle (Figure 6).

! **WARNING:** make sure, not to injure yourself or damage any part of the vehicle during this process!



Figure 6

6. For Slip-On and optional Link Pipes: unscrew and remove the engine compartment cowlings (Figure 7).

! **WARNING:** make sure, that you don't damage any part of the vehicle during this process!



Figure 7

7. **For optional Link Pipes only:** unscrew and remove the expansion tank's aluminium heat shield and unscrew the marked expansion tank's bracket bolt (**Figure 8**).

! **WARNING:** do not disconnect the cooling system hoses!

! **WARNING:** make sure, that you don't damage any part of the vehicle during this process!

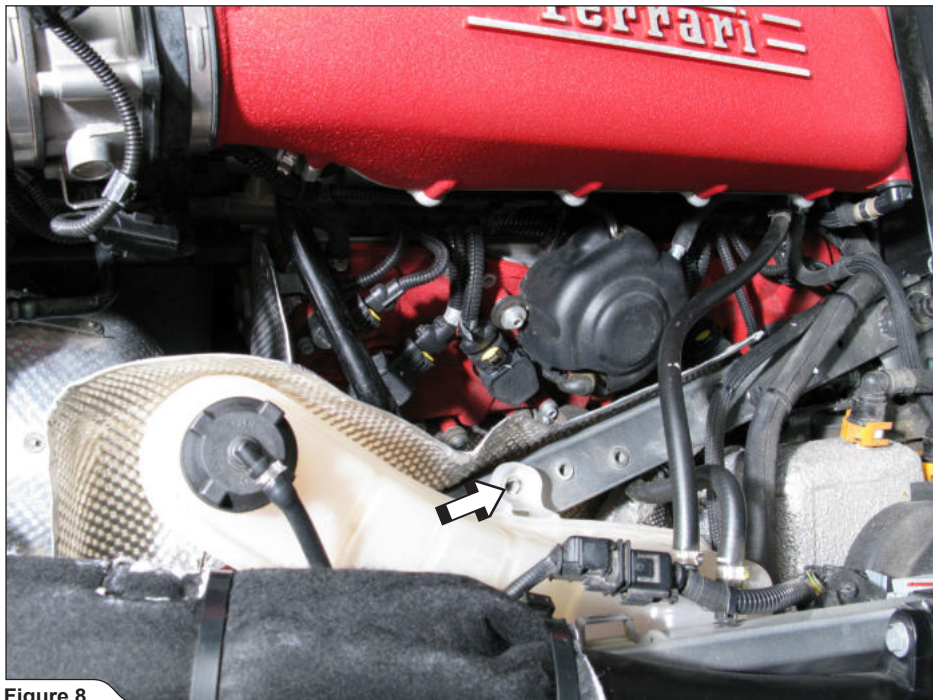

Figure 8

8. **For Slip-On only:** untighten the marked spherical clamps on both sides of the engine (**Figure 9**).
For optional Link Pipes only: unscrew and remove the marked spherical clamps on both sides of the engine (**Figure 9**).



Figure 9

9. **For Slip-On and optional Link Pipes:** disconnect the marked vacuum hose and air mass meter connector and untighten marked catalytic converter's heat shield bolts on both sides of the engine (**Figure 10**).

! **WARNING:** make sure, not to injure yourself or damage any part of the vehicle during this process!

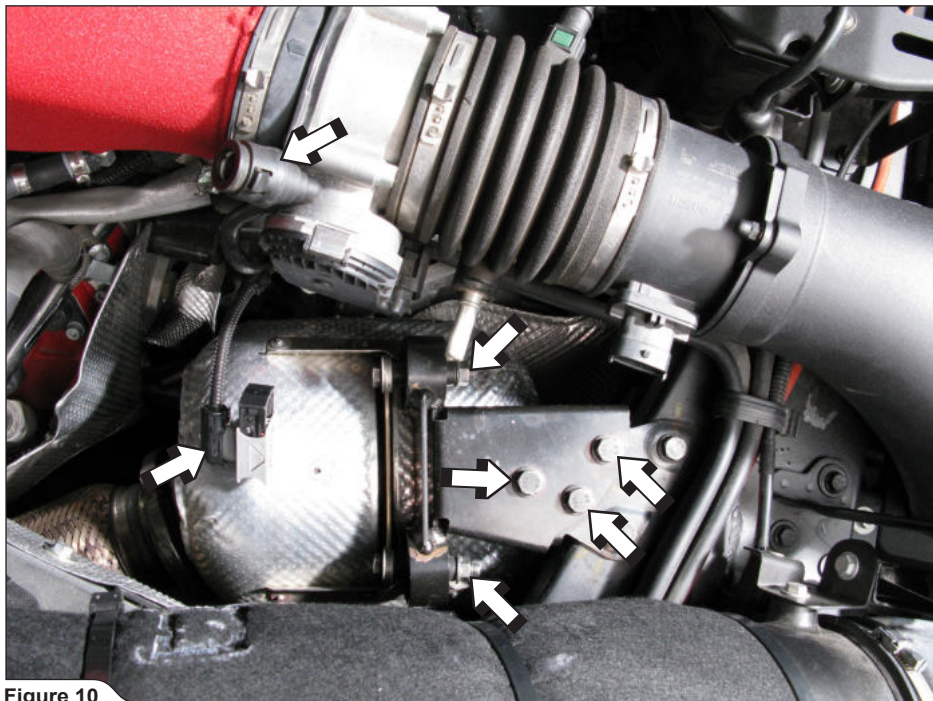

Figure 10

10. **For Slip-On and optional Link Pipes:** untighten the marked clamps and pull the vacuum hoses off the exhaust valves' actuators (**Figure 11**).

! **WARNING:** make sure, not to injure yourself or damage any part of the vehicle during this process!

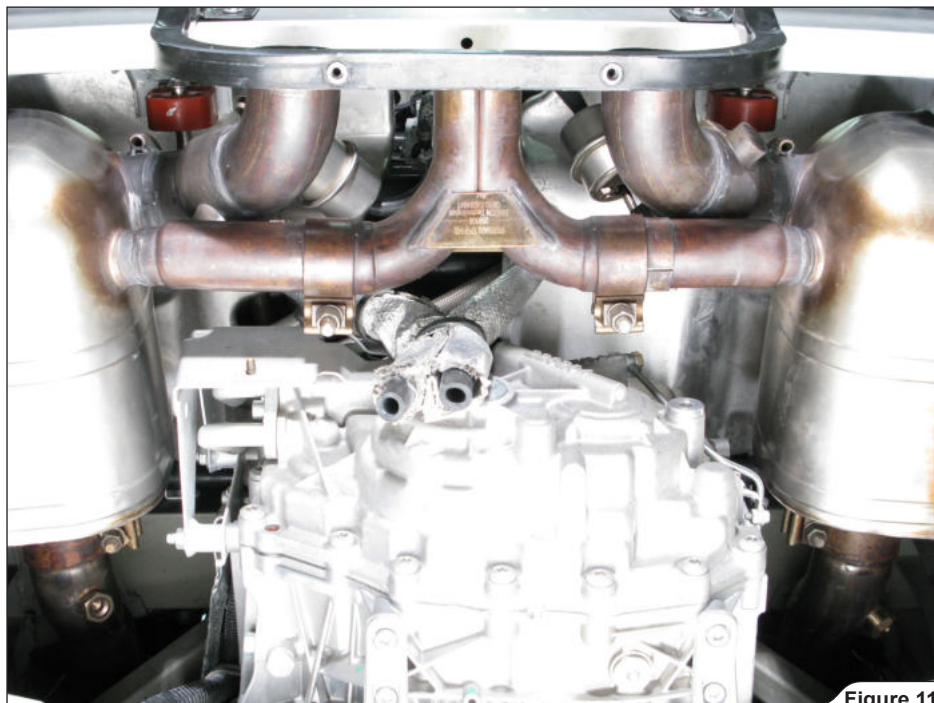

Figure 11

11. **For Slip-On and optional Link Pipes:** unscrew the mufflers' front rubber mounting nuts on both sides of the vehicle (Figure 12).

! **WARNING:** make sure, not to injure yourself or damage any part of the vehicle during this process!

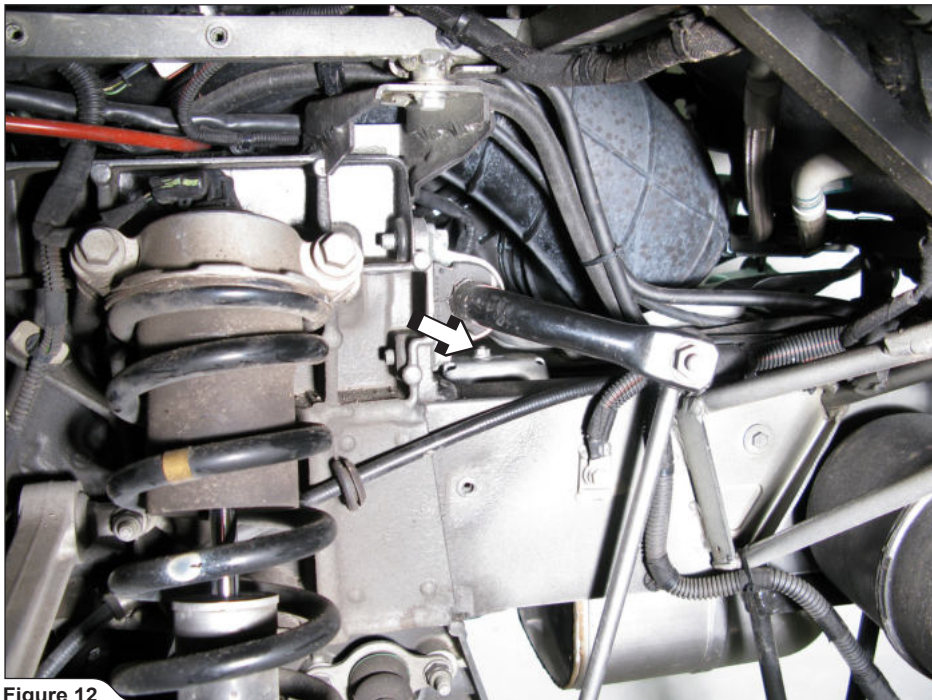

Figure 12

12. **For Slip-On and optional Link Pipes:** remove the diffuser bracket and unscrew the mufflers' rear rubber mountings' nuts. Carefully remove the mufflers off the vehicle (**Figure 13**).

! **WARNING:** make sure, not to injure yourself or damage any part of the vehicle during this process!

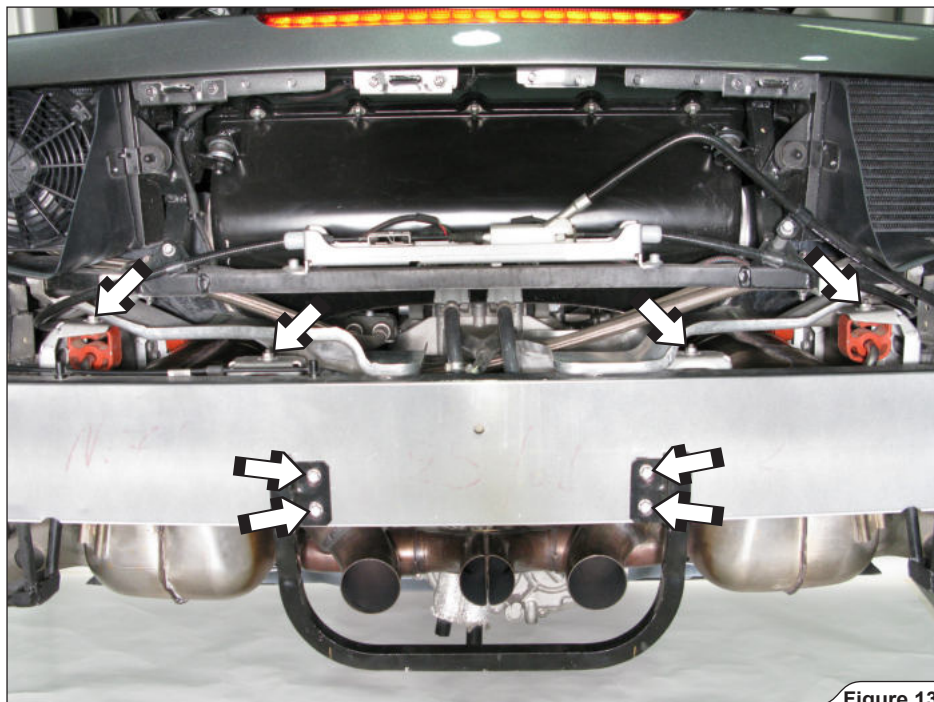

Figure 13

13. For optional Link Pipes only: carefully remove heat shields and original link pipes from both sides off the engine (Figure 14,15).

- ! **WARNING:** make sure, not to damage any part of the vehicle during this process!
- ✂ **INSTALLATION TIP:** protect the sensitive parts around the area, using masking tape or equivalent.

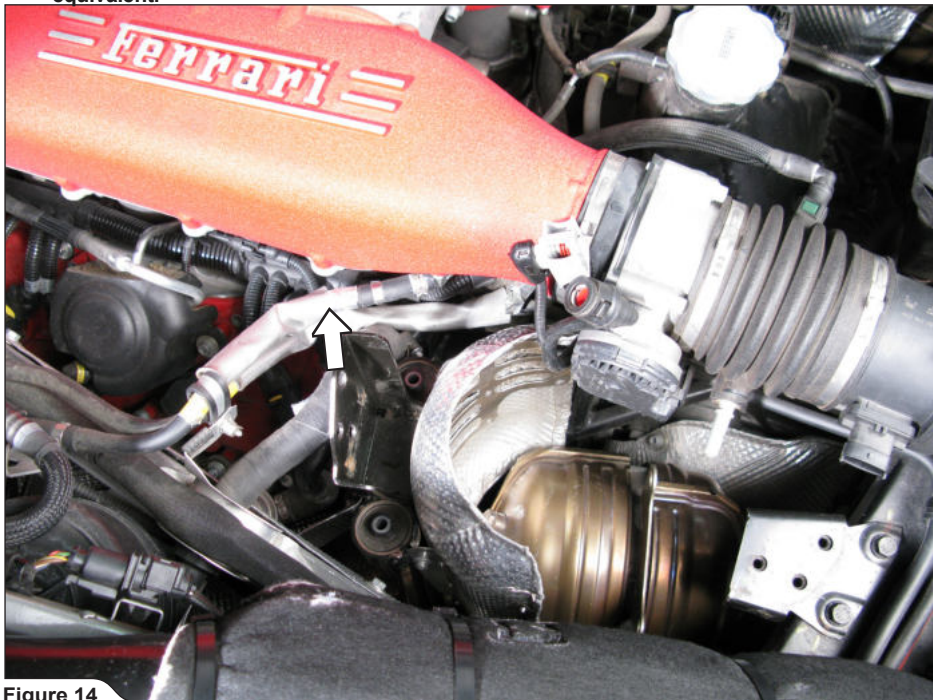

Figure 14



Figure 15

14. **For Slip-On and optional Link Pipes:** unscrew marked bolts and remove the original tail pipes off the rear bumper (**Figure 16**).

! **WARNING:** make sure, not to damage or scratch the bumper during this process!

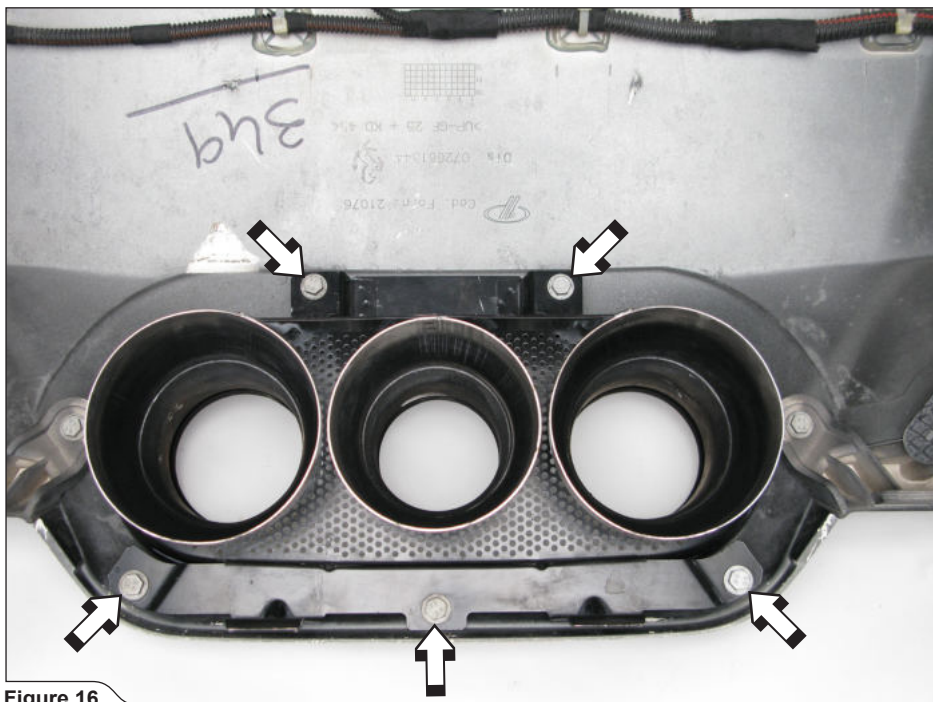

Figure 16

INSTALLATION OF THE AKRAPOVIČ EXHAUST SYSTEM:

1. **For optional Link Pipes only:** carefully Insert the Akrapovič Link Pipes into the engine compartment, as shown (Figure 17).

! **WARNING:** make sure, not to damage any part of the vehicle during this process!

! **CAUTION:** we advise, that you use new exhaust gaskets in collectors - Link Pipes joints!

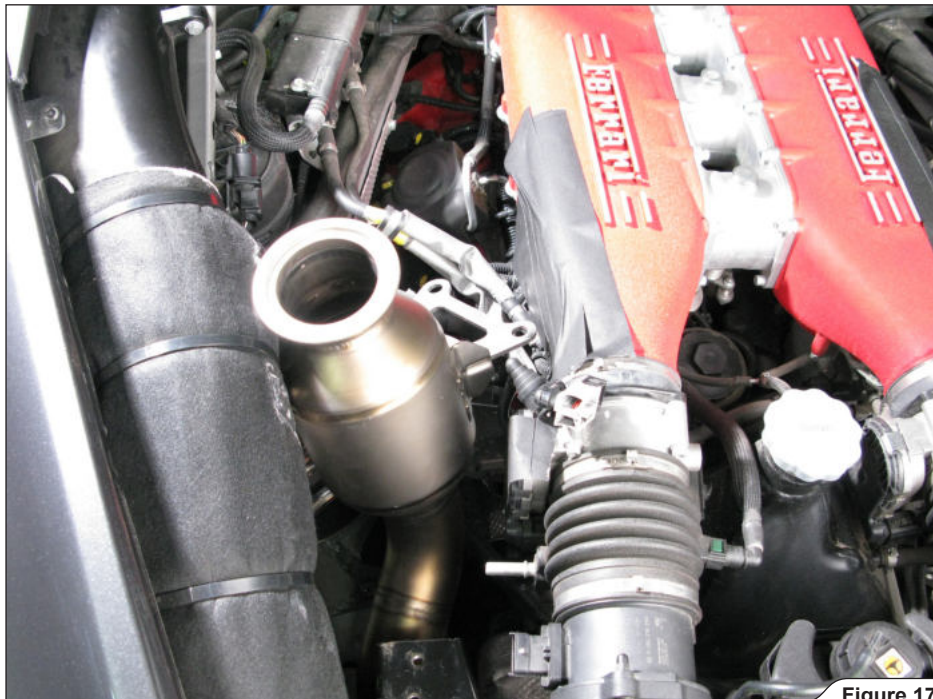

Figure 17

2. **For optional Link Pipes only:** attach the Link Pipes onto the headers and **hand** tighten the original spherical clamps on both sides of the engine (**Figure 18**).

! **WARNING:** use anti-seize copper paste on spherical clamps' bolt threads!

! **WARNING:** do not fully tighten the spherical clamps yet!

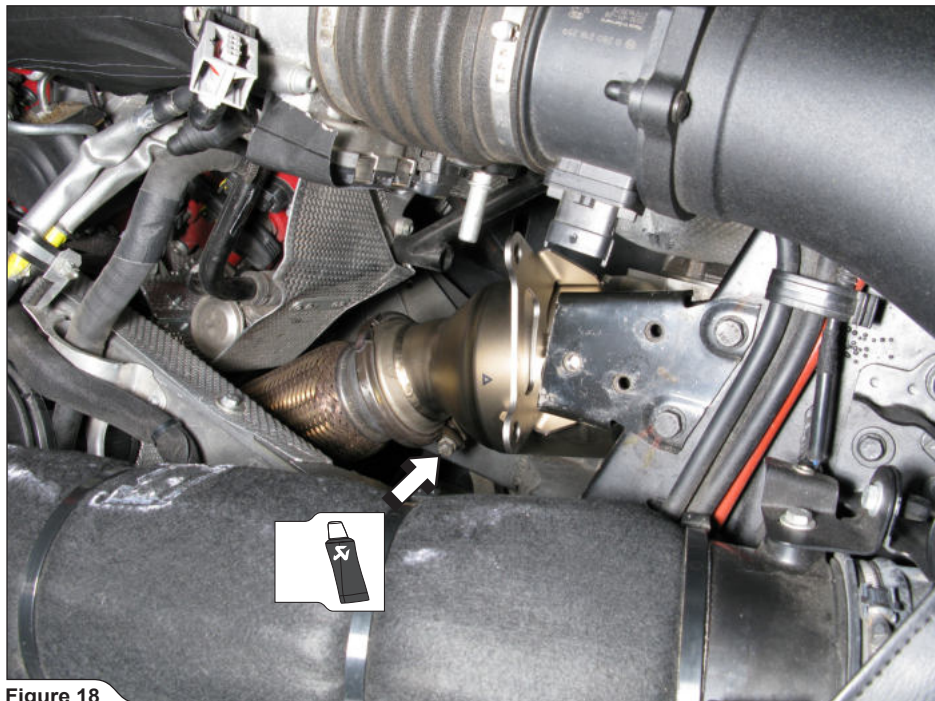

Figure 18

3. **For optional Link Pipes only:** install the lambda sensor and tighten it to the specified torque, on both Link Pipes (**Figure 19**).

! **CAUTION:** be careful not to damage the electrical lead or the lambda sensors!

! **WARNING:** use anti-seize copper paste on lambda sensors' threads!

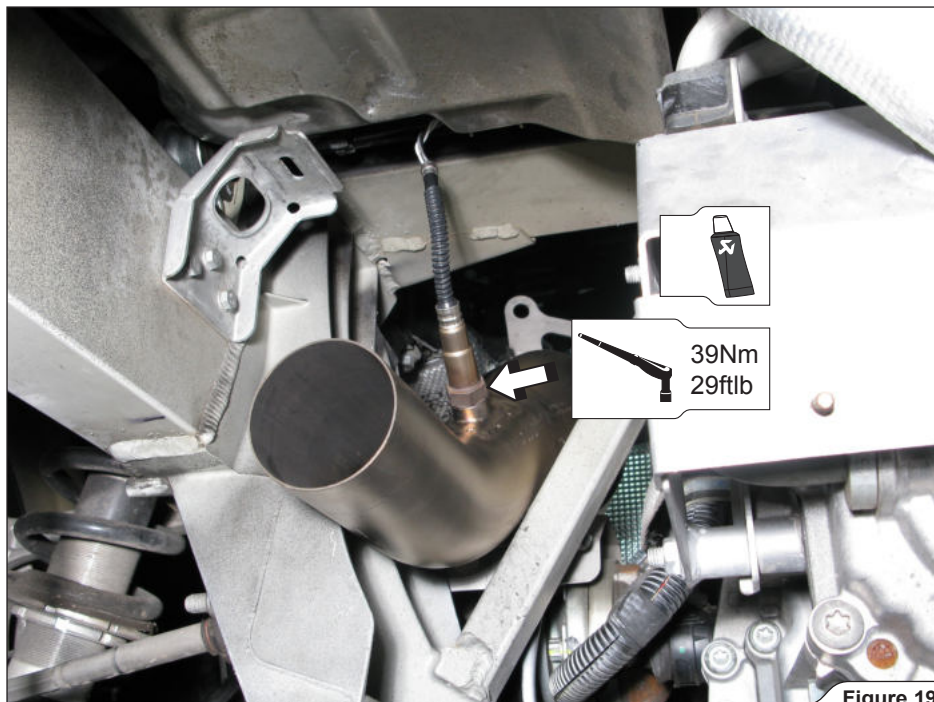

Figure 19

4. **For optional Link Pipes only:** hand tighten Link Pipes' heat shield bolts on both sides of the engine; use original bolts, washers and nuts (**Figure 20**).

! **WARNING:** do not fully tighten the bolts yet!



Figure 20

5. **For Slip-On and optional Link Pipes:** correctly attach the vacuum actuators onto both exhaust valves, using spring washer, circlips and M6 nuts from Akrapović installation kit and original heat resistant spacers (**Figure 21, 22**).

! **WARNING:** use anti-seize copper paste on all nut threads and spring washers!



Figure 21

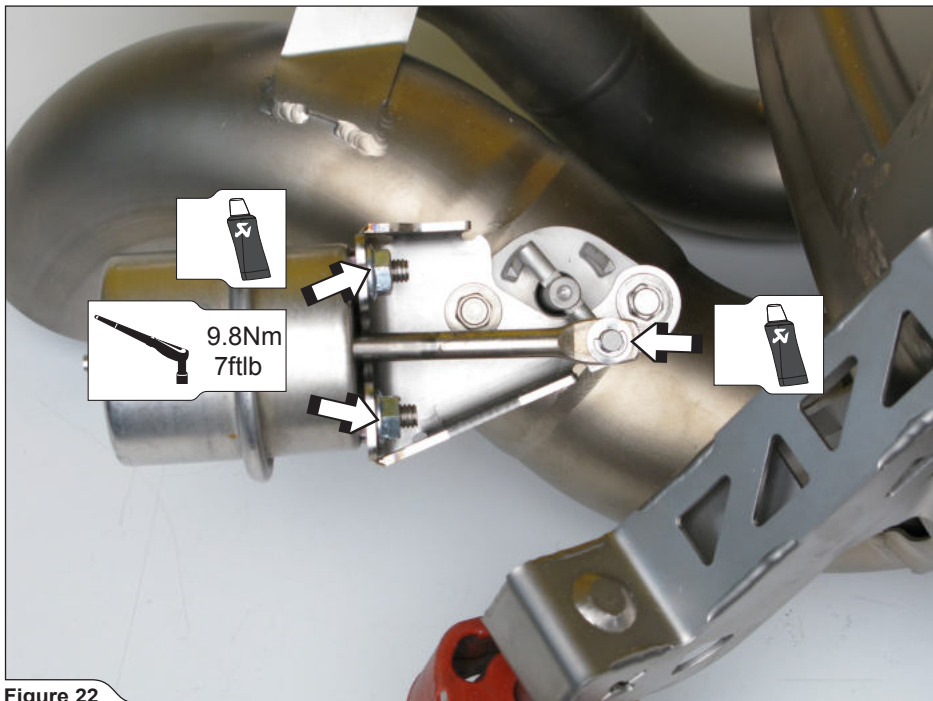

Figure 22

6. **For optional Link Pipes only:** attach the original rubber mountings and Akrapovič clamps onto the mufflers and collector, as shown (Figure 23).

✂ **INSTALLATION TIP:** for easier mounting, lubricate the stock rubber brackets.

! **WARNING:** use anti-seize copper paste on clamp bolt threads!

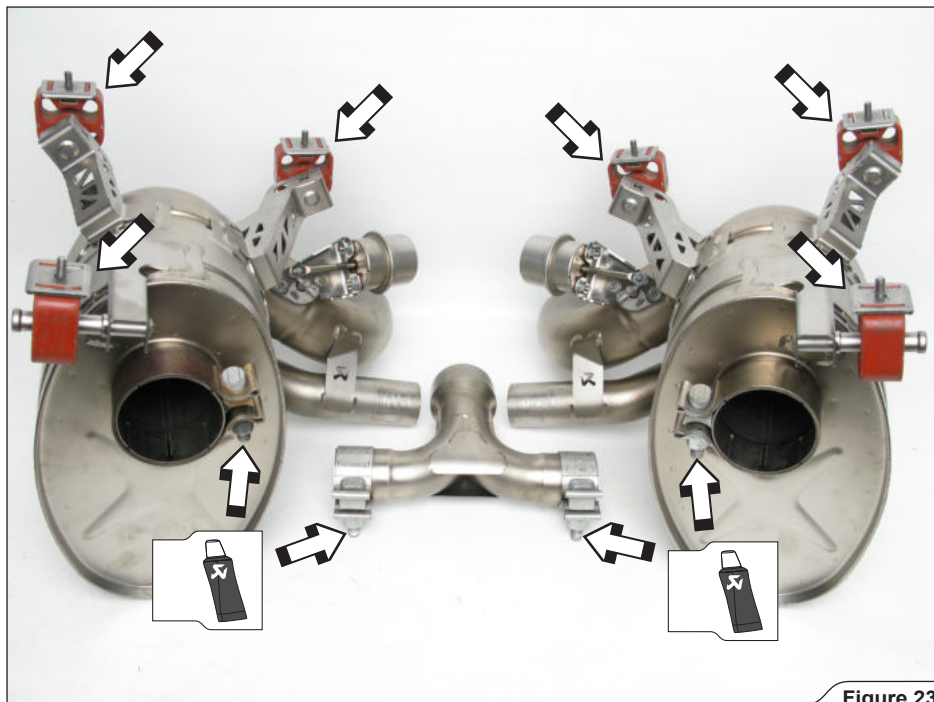

Figure 23

7. **For Slip-On only:** attach the original rubber mountings, Akrapovič Slip-On adapters and clamps onto the mufflers and collector, as shown (Figure 24).

✚ INSTALLATION TIP: for easier mounting, lubricate the stock rubber brackets.

! WARNING: use anti-seize copper paste on clamp bolt threads!

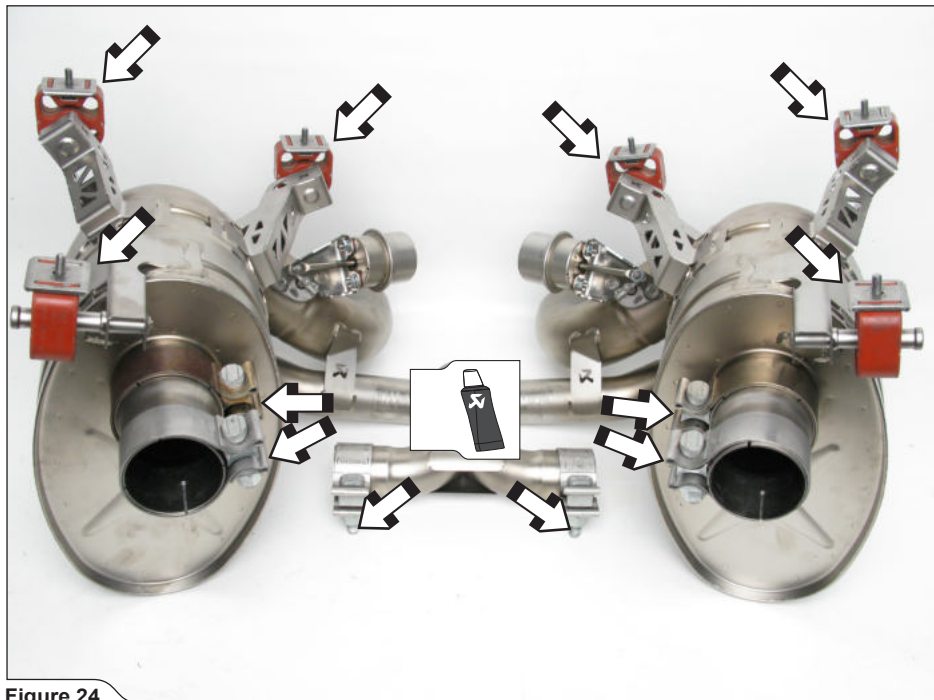

Figure 24

8. **For Slip-On and optional Link Pipes:** slide the mufflers onto the Link Pipes and simultaneously insert the mufflers' collector. Center the mufflers in respect to the chassis, align the rubber mountings and tighten them onto the chassis brackets (**figure 25, 26**).

! **WARNING:** before tightening the rubber mountings, align them in the middle of the chassis brackets!

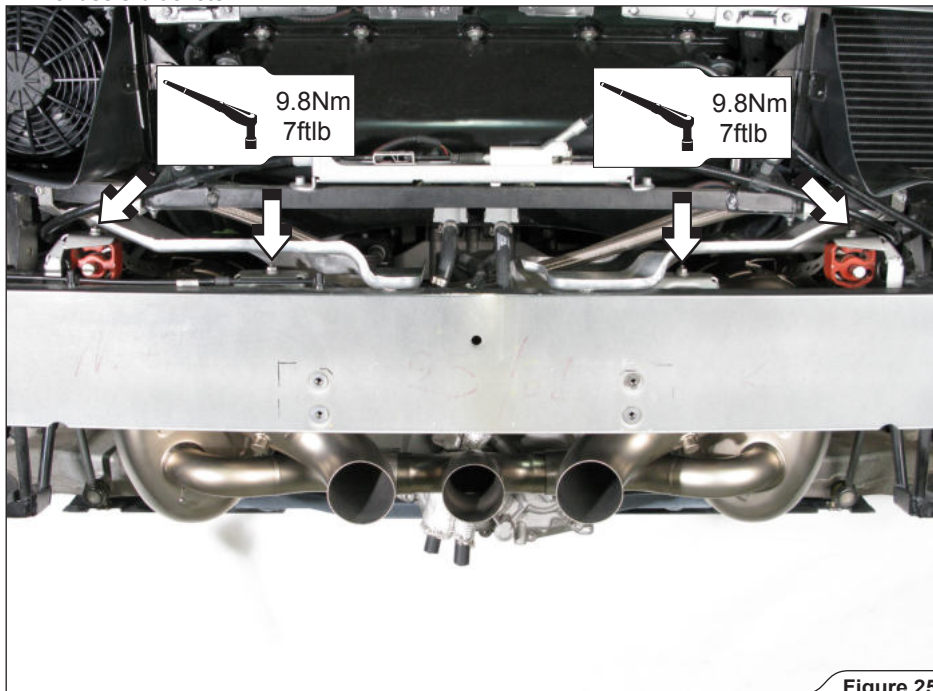

Figure 25

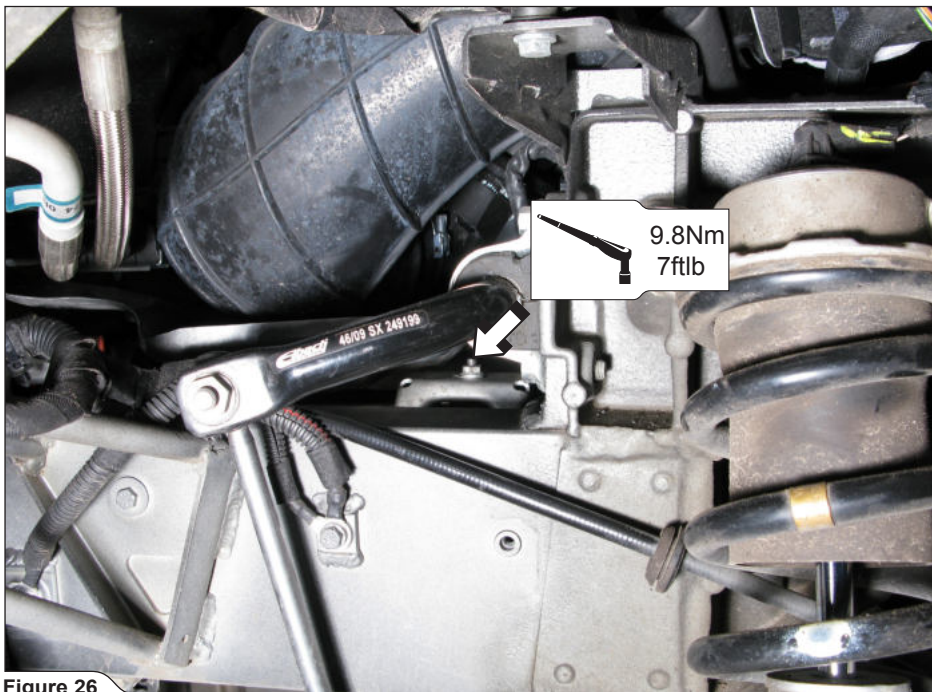

Figure 26

9. **For optional Link Pipes only:** align the collector's outlet in respect to the mufflers' outlets and tighten all clamps to the specified torque (**Figure 27**).

! **WARNING:** link pipes must be inserted 43mm into the mufflers' inlets!

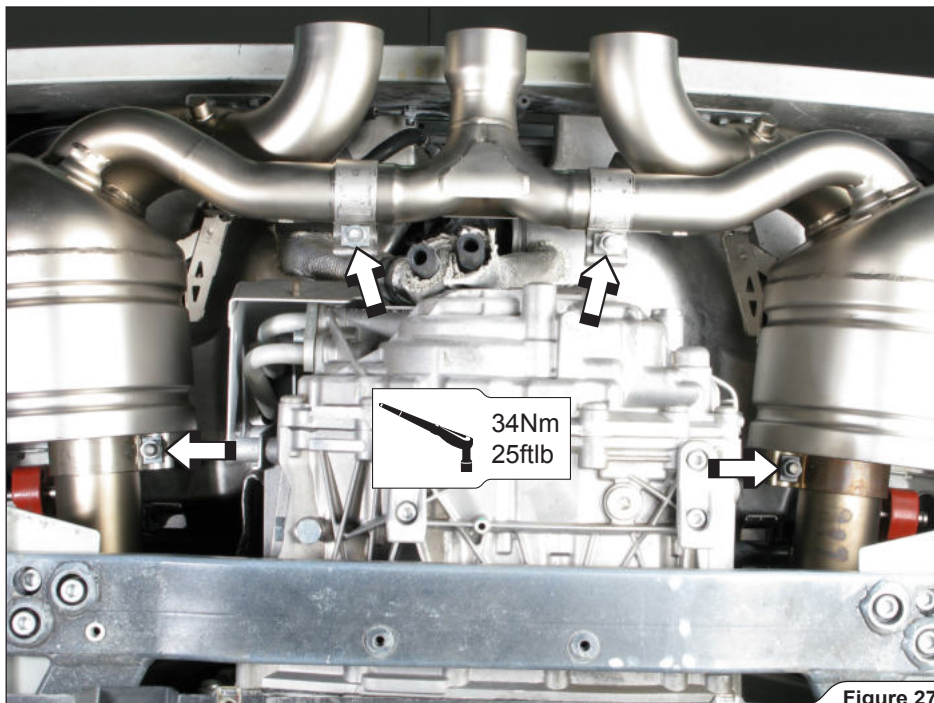

Figure 27

10. **For Slip-On only:** align the collector's outlet in respect to the mufflers' outlets, center Akrapovič Slip-On adapters and tighten all clamps to the specified torque (**Figure 28**).

! **WARNING:** adapters must be inserted 43mm into the mufflers' inlets!

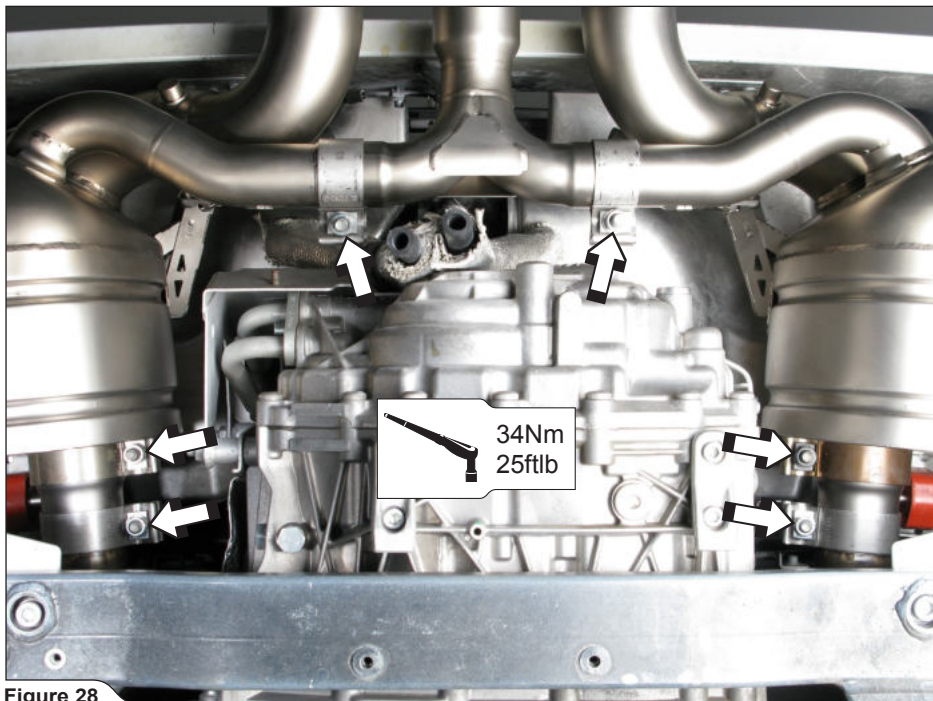

Figure 28

11. **For Slip-On and optional Link Pipes:** reconnect the marked vacuum hose and air mass meter connector and tighten marked catalytic converter's heat shield bolts on both sides of the engine to the specified torque (**Figure 29**).

! **WARNING:** make sure, not to damage any part of the vehicle during this process!

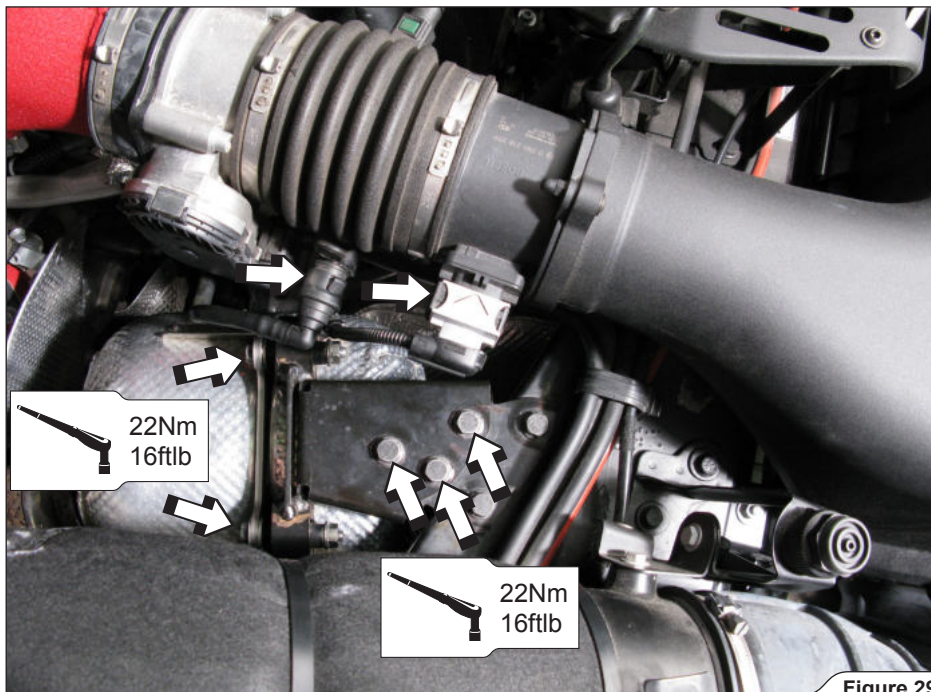

Figure 29

12. **For Slip-On and optional Link Pipes:** tighten the original spherical clamps on both sides of the engine to the specified torque (**Figure 30**).

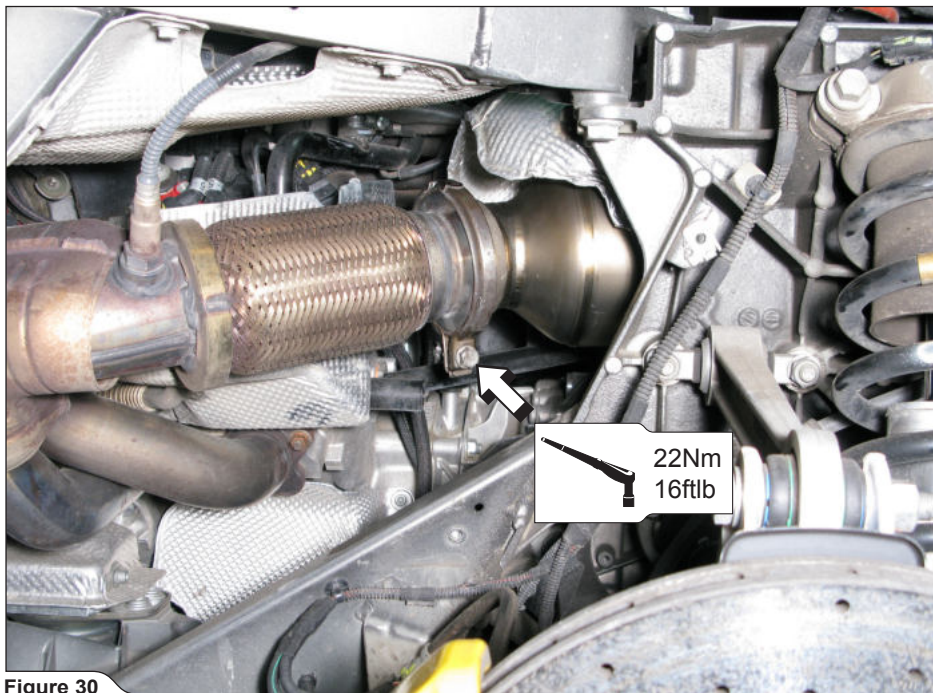

Figure 30

13. **For Slip-On and optional Link Pipes:** cut and prolong the right vacuum hose as shown, using aluminium tube and tape clamps from the installation kit (**Figure 31, 32**).

! WARNING: make sure, not to injure yourself or damage any part of the vehicle during this process!

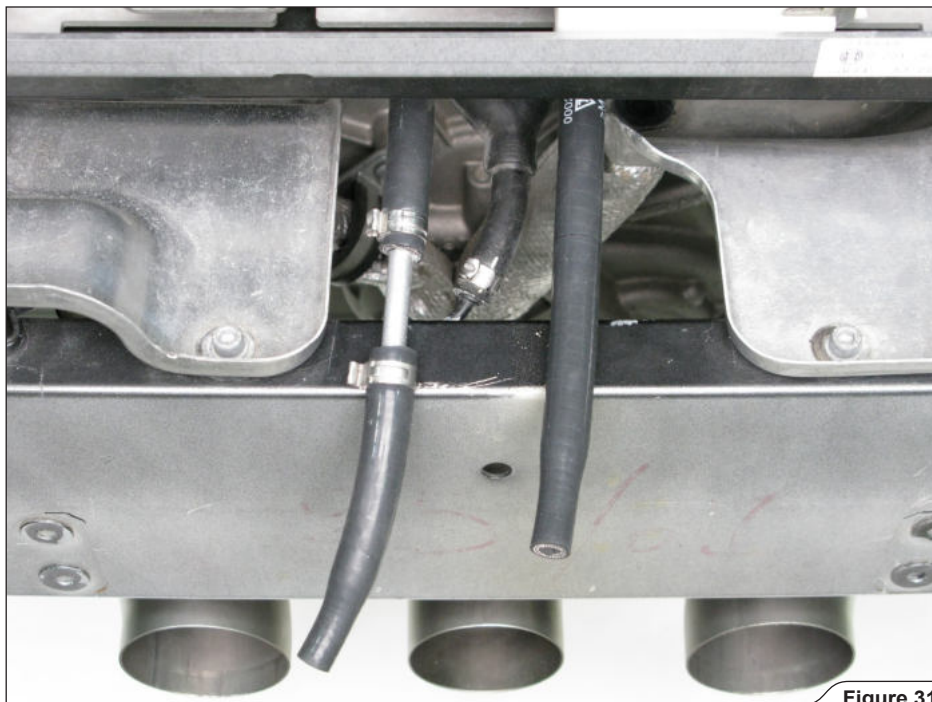

Figure 31

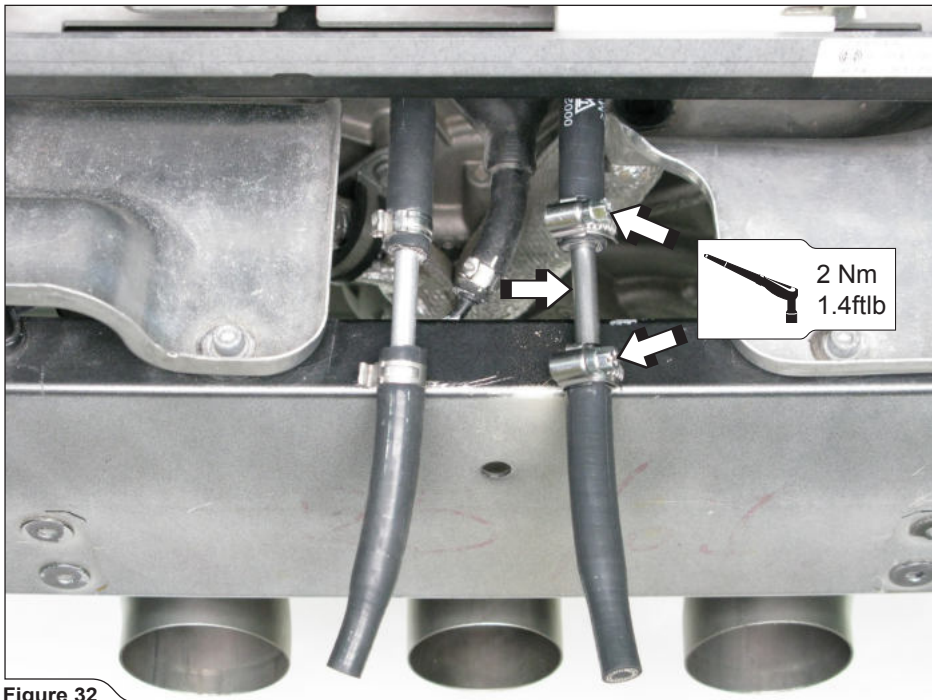

Figure 32

14. **For Slip-On and optional Link Pipes:** attach the vacuum hoses onto the vacuum actuators (Figure 33).

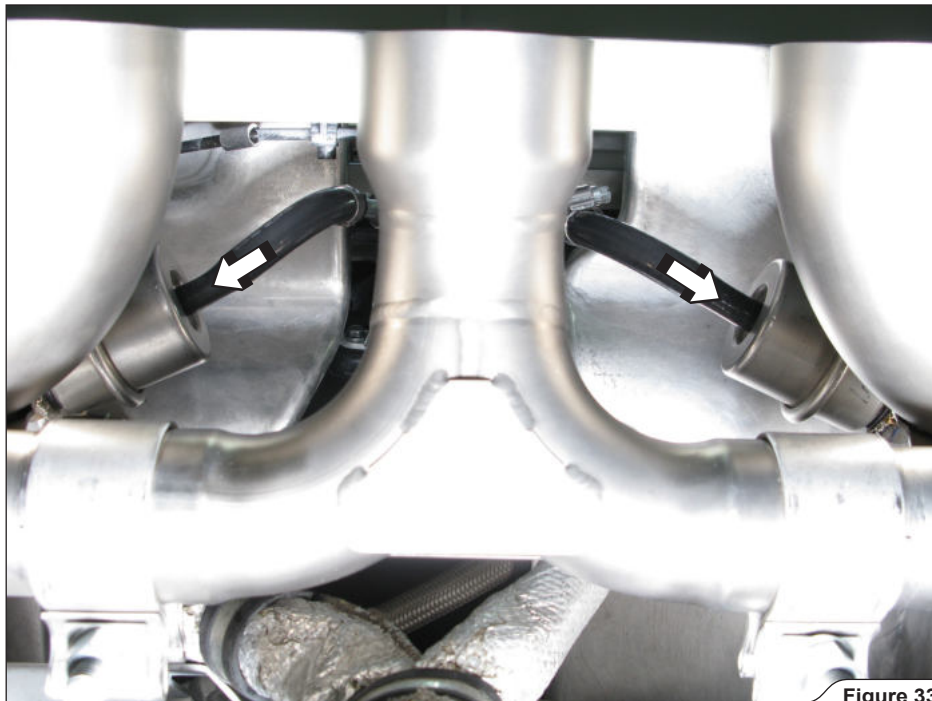

Figure 33

15. **For Slip-On and optional Link Pipes:** put the washers from installation kit, onto the rear bumper's Tail Pipe brackets (**Figure 34**).

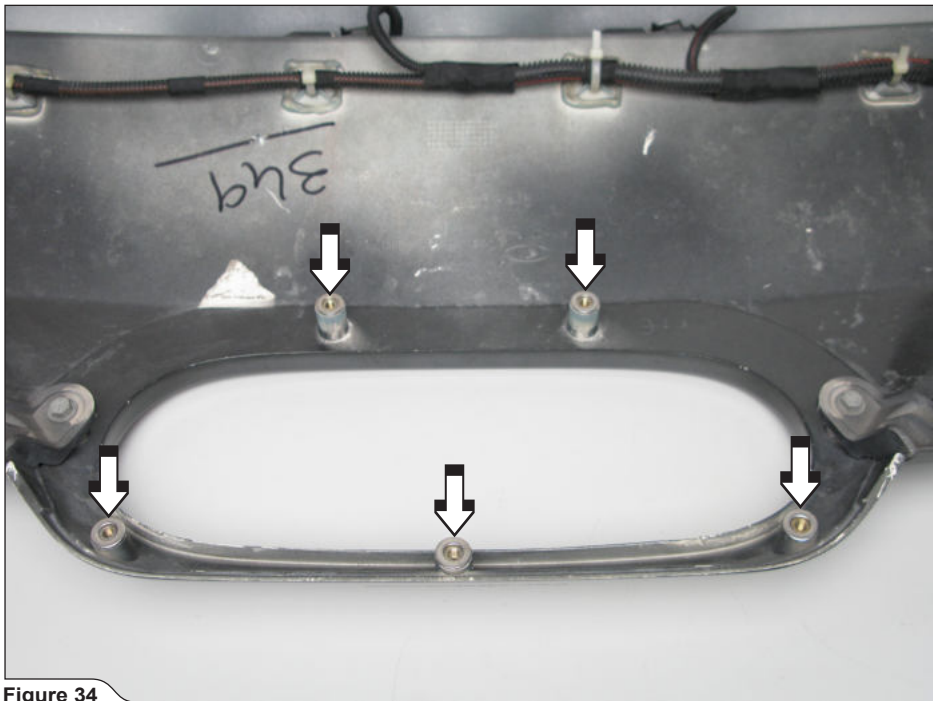
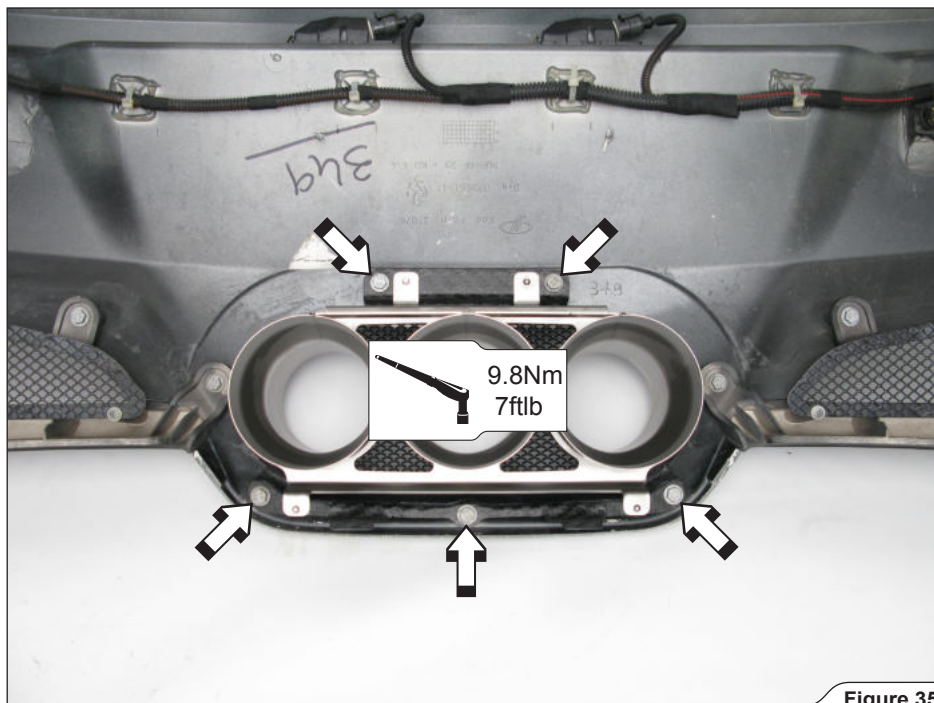

Figure 34

16. **For Slip-On and optional Link Pipes:** attach the Akrapovič Tail Pipes onto the rear bumper, using original bolts (Figure 35).



17. **For Slip-On and optional Link Pipes:** replace the dismantled engine compartment cowlings, rear bumper, wheel arch panels, rear wheels and diffuser in the reverse order from the order in which they were removed. Check vehicle manufacturer manual for tightening torques.
- ! **CAUTION:** in case the exhaust system outlets doesn't align with Tail Pipes (Figure 36), repeat the adjustment of the mufflers!



Figure 36

18. For optional Akrapovič delete-R: locate and unscrew the original OBD connector (Figure 37, 38).



Figure 37



Figure 38

19. For optional Akrapovič delete-R: plug the original OBD connector into the delete-R's OBD connector (Figure 39).

! **WARNING:** make sure, that connectors are joint correctly!

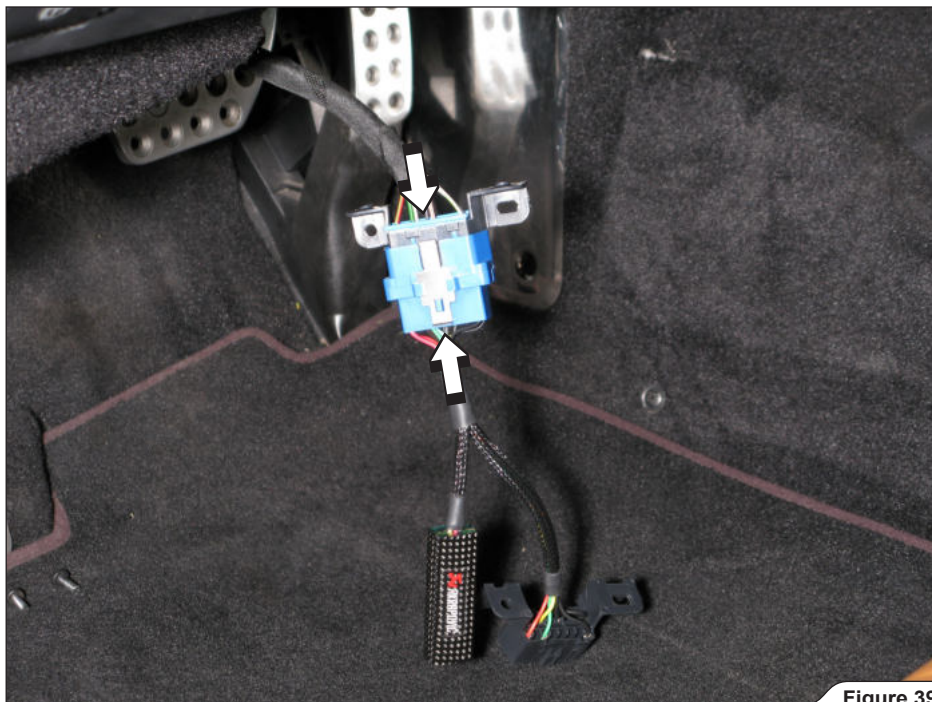

Figure 39

20. For optional Akrapovič delete-R: attach the delete-R's OBD connector onto the chassis and fix the Akrapovič delete-R, wires and original OBD connector, using the plastic tie wraps (Figure 40).
- ! **WARNING:** fix the delete-R, wires and original OBD connector in such a way, they don't interfere with any moving parts (steering, pedals)!
- ! **WARNING:** after the delete-R is installed, no special attention is needed. If the emission light was ON before installation, it will go OFF after some driving!

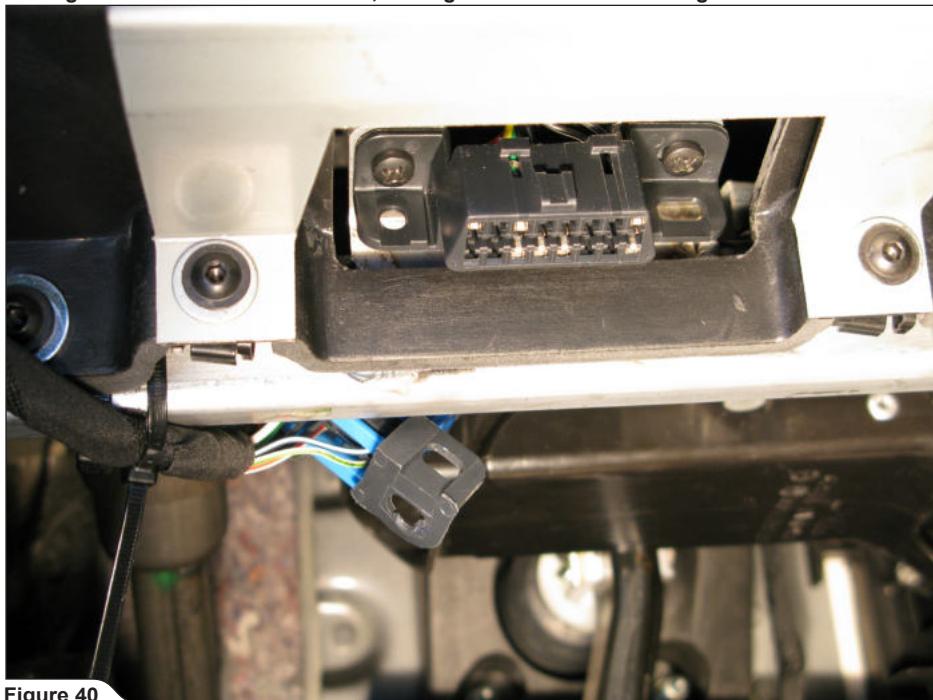

Figure 40

Final installation:

- ! **WARNING: check vehicle manufacturer manual for tightening torques (for dismounted stock parts)!**
- ! **WARNING: make sure all the nuts and bolts are sufficiently tightened. In case the exhaust system touches the cowl or other parts, repeat the adjustment of the exhaust system or contact your authorized dealer.**

OPTIONAL AKRAPOVIČ DELETE-R PURPOSE AND OPERATION:

This device will eliminate eventual error codes possibly caused by the high flow catalyts used in the Akrapovič Slip-On exhaust system with optional link pipes.

MAINTENANCE OF THE AKRAPOVIČ EXHAUST SYSTEM:

1. Clean the titanium exhaust components with a multi-purpose spray lubricant (WD-40 or equivalent), carbon fiber exhaust components with soft and dry cloth and stainless steel components with soft cloth sprayed with contact cleaner, then wipe with soft and dry cloth. A change in the color of the exhaust system is normal due to high temperatures.
2. Periodically make sure all the bolts and springs are sufficiently tight.

- ! **WARNING: clean all exhaust components before the first start of the engine or the stains will burn onto the surfaces!**
- ! **IT IS NORMAL IF WHITE SMOKE COMES OUT OF THE MUFFLER ON FIRST OPERATION.**
- ! **DO NOT STAND BEHIND THE MUFFLER ON FIRST OPERATION.**
- ! **DO NOT USE AUTOMOTIVE WHEEL CLEANERS OR ANY CLEANING PRODUCTS WHICH CONTAIN ACIDIC ADDITIVES TO CLEAN AKRAPOVIČ EXHAUST SYSTEMS.**

FERRARI 458 ITALIA/Titanium exhaust system/ Slip on / EC Type approval

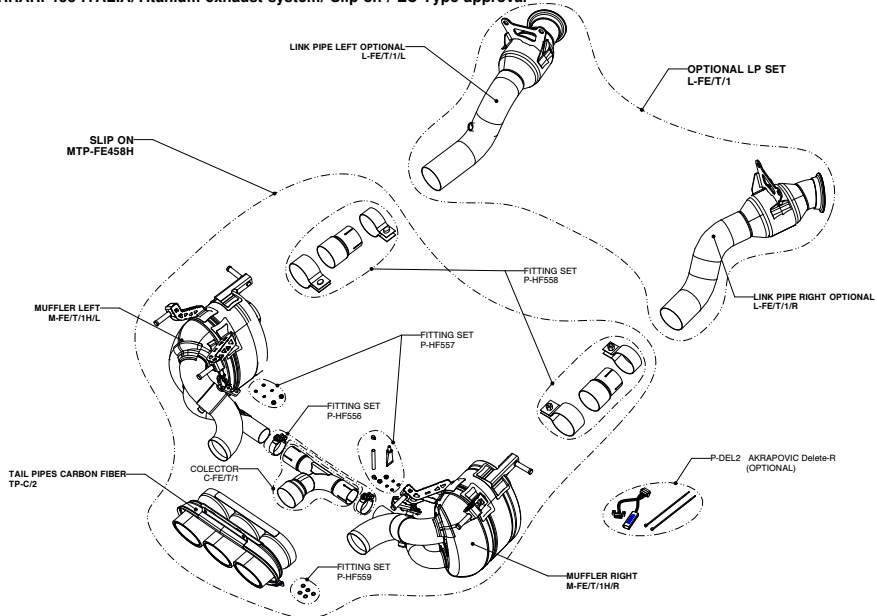

www.akrapovic.com



502894