

BSS060

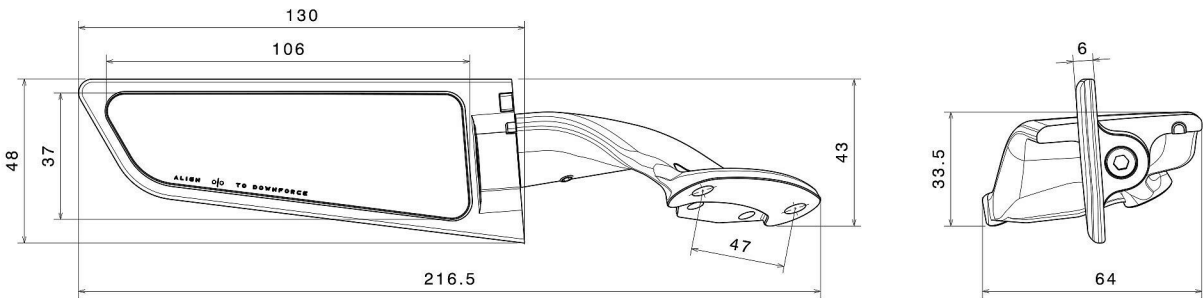

Attention: the drawing represents the left side mirror. The right side mirror is symmetrical to the left.

BSS060

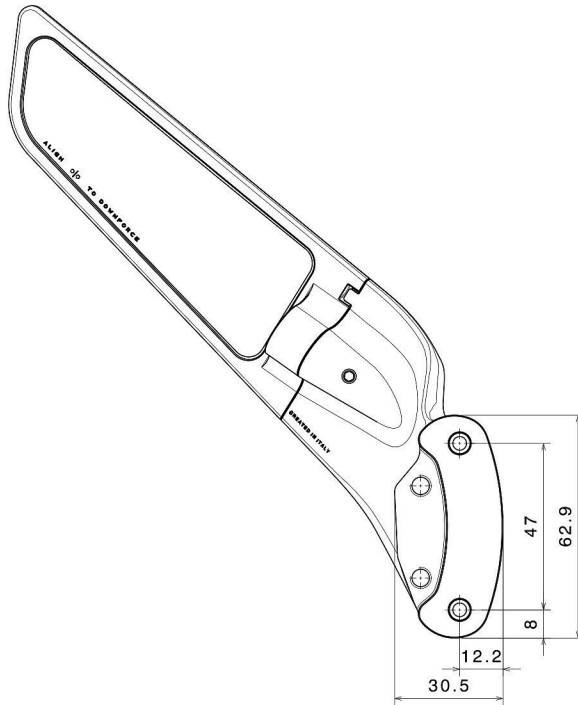

Attention: the drawing represents the left side mirror. The right side mirror is symmetrical to the left.