

BSS031

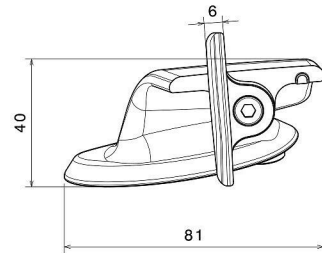
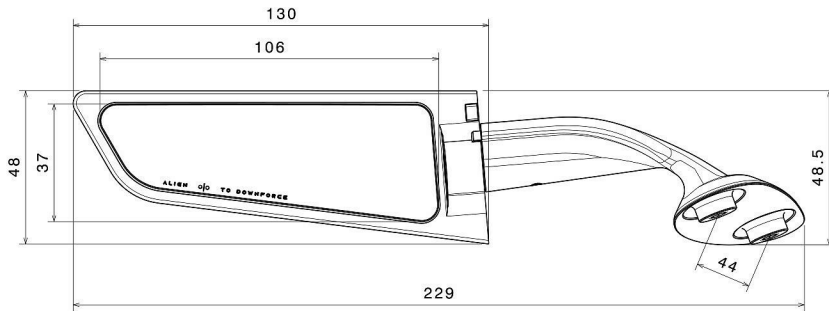

Attention: the drawing represents the left side mirror. The right side mirror is symmetrical to the left.