

Note!

Before installing this product, check the contents of the kit. If anything is missing, please contact an Öhlins dealer.

Kit Contents

Description	Part No	Pcs
Shock absorber	YA357	2
Sticker Öhlins	00192-01	2
C-spanner	00710-01	1
Owners manual	07241-02	1

Note!

Please note that this image is a general representation of the product and may differ slightly from your product.

Note!

Please note that during storage and transportation, especially at high ambient temperature, some of the oil and grease used for assembling may leak and stain the packaging. This is in no way detrimental to the product, wipe off the excessive oil/grease with a cloth.

Warning!

Before installing this product, read the Öhlins Owner's Manual. The shock absorber is an important part of your vehicle and will affect the stability.

Shock Absorber for YAMAHA Bolt

YA357

Mounting Instructions

MOUNTING INSTRUCTIONS

Warning!

It is advisable to have an Öhlins dealer install the shock absorber.

Warning!

If working on a raised vehicle, ensure it is securely supported so that it will not tip over.

1

Put the motorcycle on a work stand so that the rear wheel barely touches the ground. Make sure the motorcycle is in a stable position.

2

Remove the standard shock absorber by loosening the upper bolt (1) and the lower mount nut (2).

3

Install the Öhlins shock absorber on the motorcycle.

Tighten the upper bolt (3) and the lower mount nut (4) as per torque value specified in YAMAHA service manual.

Note!

Before mounting this product clean the vehicle thoroughly.

Note!

When working on this product, always see the Vehicle Service Manual for vehicle specific procedures and important data.

MOUNTING INSTRUCTIONS

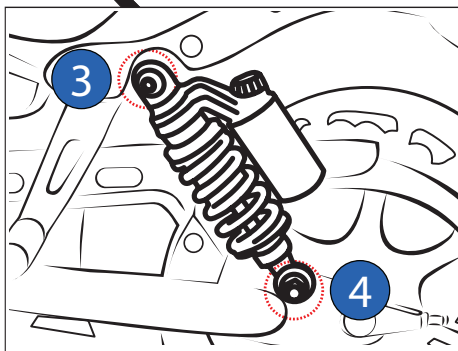
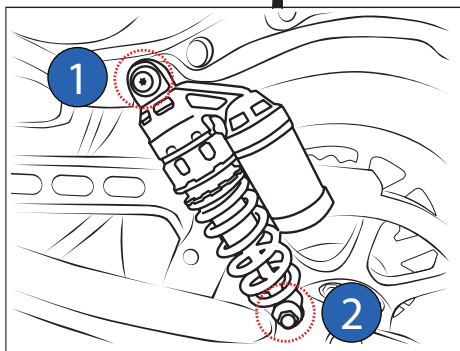
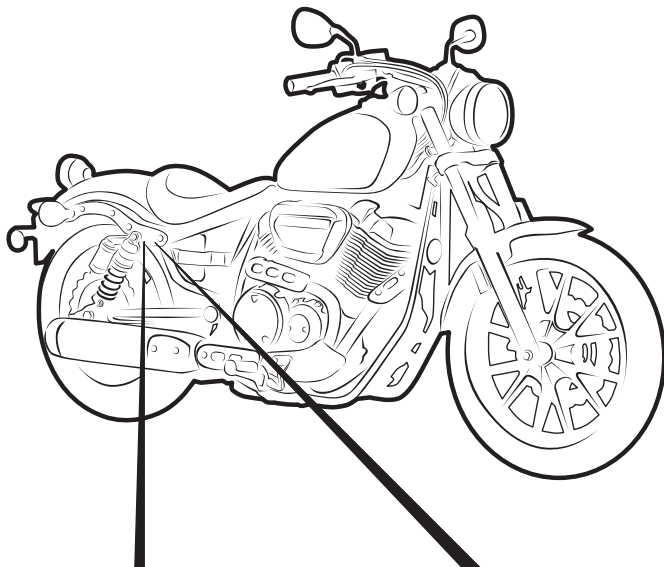

Note!

Lower the vehicle so that the suspension is slightly compressed before tightening the screws.

Caution!

Ensure that all screws are tightened to the correct torque and that nothing fouls or restricts movement of the shock absorber when the suspension is fully compressed or extended.

ADJUSTMENTS

⚠ Warning!

Before riding, always make sure that the basic settings made by Öhlins are according to recommended Set-up Data. Read about adjustments and setting up in the Öhlins Owner's Manual before you make any adjustments. Contact an Öhlins dealer if you have any questions about setting up.

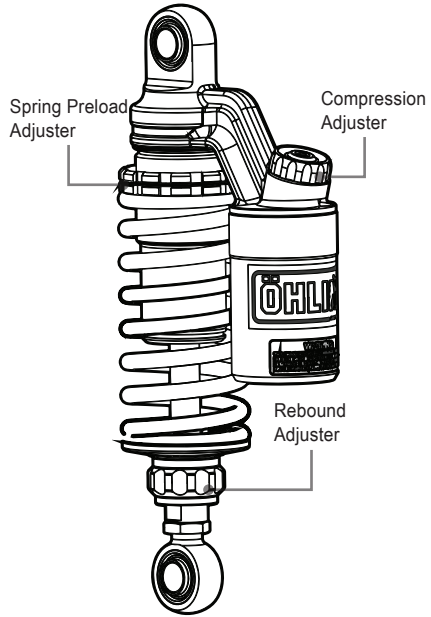
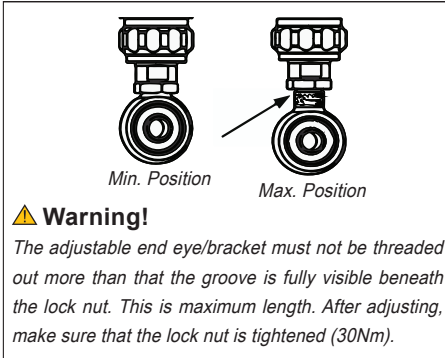

SET-UP DATA

Recommended set-up

Spring Preload	10 mm
Rebound adjuster	14 Clicks
Compression adjuster	14 Clicks

Shock absorber data

Length	255 ⁺⁷ / ₃ mm
Stroke	50 mm

Spring

Part No	60281-27
Free spring length	125 mm

👁 Öhlins products are subject to continuous improvement and development, therefore, although these instructions include the most up-to-date information available at the time of printing, minor updates may occur.

To find the latest information contact an Öhlins distributor. Please contact Öhlins if you have any questions regarding the contents in this document.

Part no. MI_YA357_EN_0
Issued 2014-11-04

© Öhlins Asia Co. Ltd. All rights reserved. Any reprinting or unauthorized use without the written permission of Öhlins Racing AB is prohibited.

Öhlins Asia Co. Ltd
700/937 Moo5, Tambol Nongkhaga,
Amphur Phantong, Chonburi Province
20160 Thailand



www.ohlins.com