

Note!

Please note that this image is a general representation of the product and may differ slightly from your product.

Note!

Please note that during storage and transportation, especially at high ambient temperature, some of the oil and grease used for assembling may leak and stain the packaging. This is in no way detrimental to the product, wipe off the excessive oil/grease with a cloth.

Note!

Before installing this product, check the contents of the kit. If anything is missing, please check an Öhlins dealer.

Kit Contents

Description	Part No	Pcs
Shock absorber	KA 008	1
C-spanner S36	60710-01	2
Sticker set "ÖHLINS"	10207-01	1
Owners manual	07251-02	1
Alternative spring		
Spring	60294-62	1

Warning!

Before installing this product, read the Öhlins Owner's Manual. The shock absorber is an important part of your vehicle and will affect the stability.

Shock Absorber for Kawasaki KLX 230

KA 008

Mounting Instructions



MOUNTING INSTRUCTIONS

⚠ Warning!

It is advisable to have an Öhlins dealer install the shock absorber.

⚠ Warning!

If working on a raised vehicle, ensure it is securely supported so that it will not tip over.

👁 Note!

Before mounting this product clean the vehicle thoroughly.

👁 Note!

When working on this product, always see the Vehicle Service Manual for vehicle specific procedures and important data.

1

Put the motorcycle on a work stand so that the rear wheel barely touches the ground. Make sure the motorcycle is in a stable position.

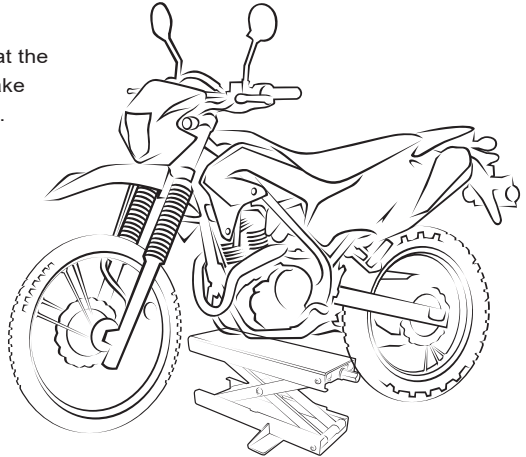

2

2.1 On the LH side : use the ignition key ① to unlock the rear fairing.

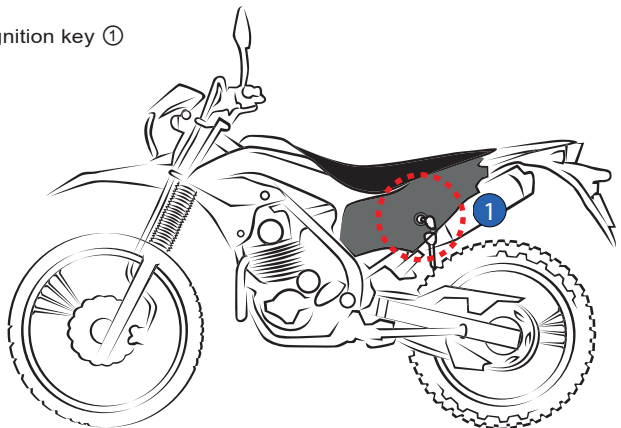

MOUNTING INSTRUCTIONS

2

2.2 On the RH side, remove the rear fairing by loosening the bolts ① ②

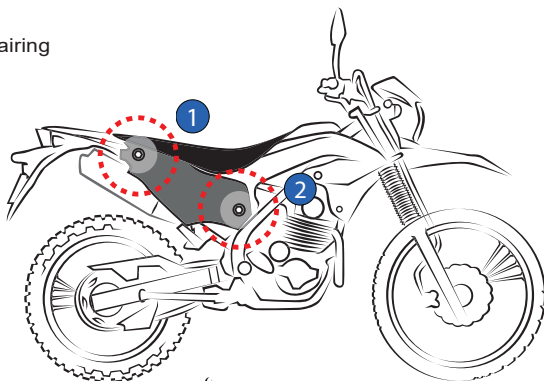

3

Remove the seat by loosening the 2 bolts ① ②

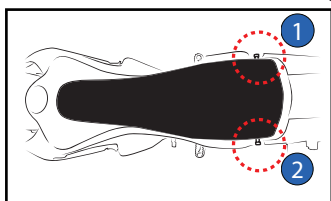
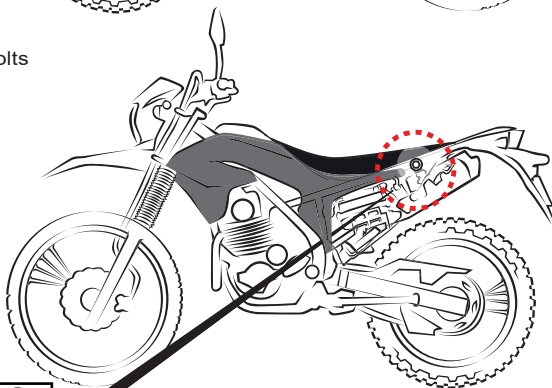

4

Remove 12 screws (6 per side) that holds the LH and RH fairing in order to access to the standard shock absorber top mounting bolt.

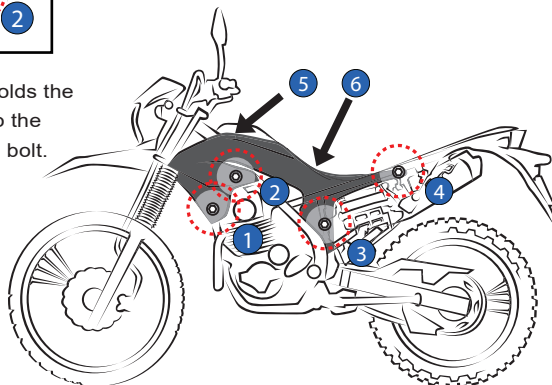

MOUNTING INSTRUCTIONS

5

Remove the top mounting bolt ① and the bolts ②③ from the linkage in order to remove the standard shock absorber.

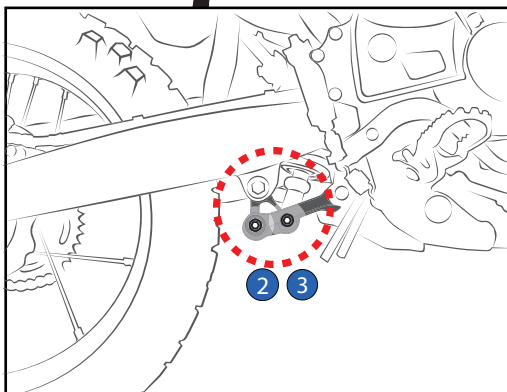
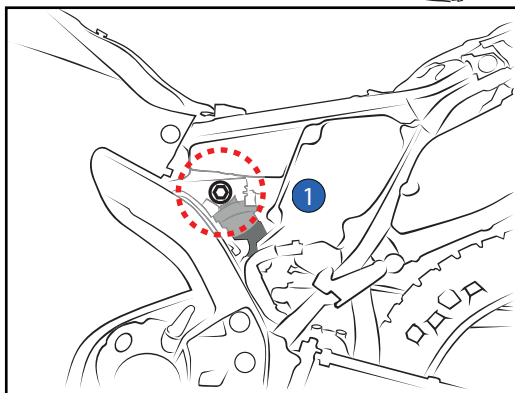
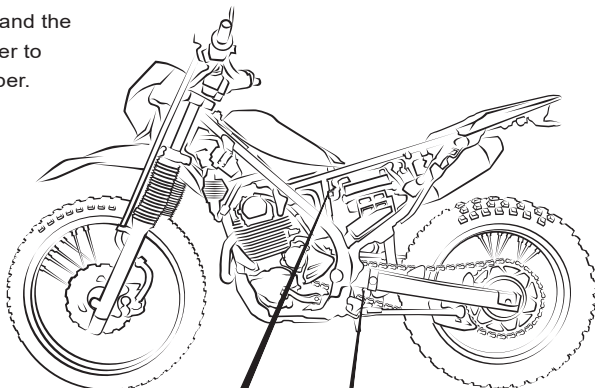

MOUNTING INSTRUCTIONS

👁 **Note!**

Filling valve screw forward to the front of motorcycle

6

Install the Öhlins shock absorber with the filling valve pointing forward as per diagram P1.

Tighten the upper mounting bolt ① and the linkage bolts ②③ at a torque value as per Kawasaki service manual instructions.

Reverse all procedure as necessary.

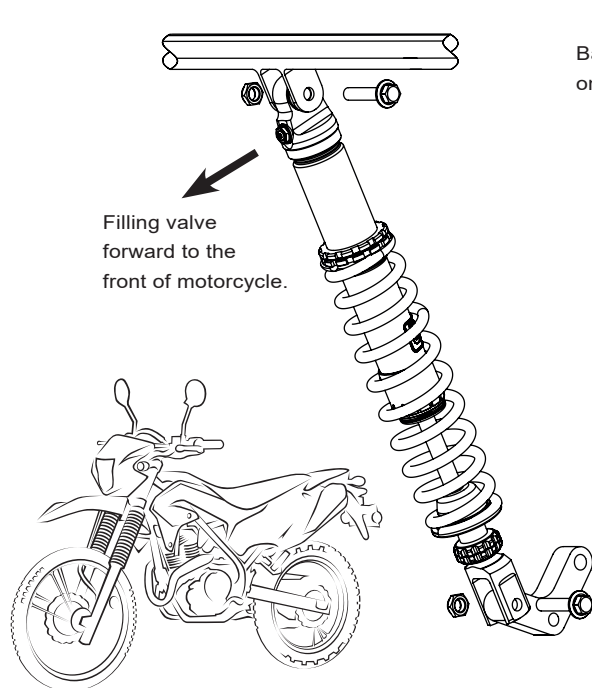
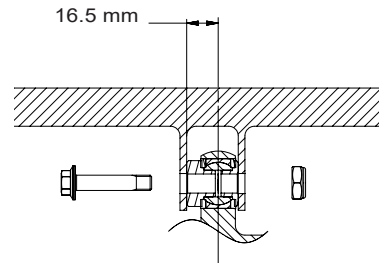

Battery box
on left side.

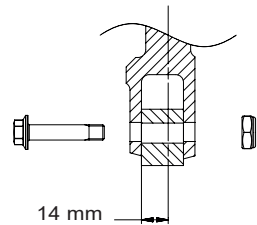

👁 **Note!**

Lower the vehicle so that the suspension is slightly compressed before tightening the screws.

👉 **Caution!**

Ensure that all screws are tightened to the correct torque and that nothing fouls or restricts movement of the shock absorber when the suspension is fully compressed or extended.

This page intentionally left blank

This page intentionally left blank

ADJUSTMENTS

⚠ Warning!

Before riding, always make sure that the basic settings made by Öhlins are according to recommended Set-up Data. Read about adjustments and setting up in the Öhlins Owner's Manual before you make any adjustments. Contact an Öhlins dealer if you have any questions about setting up.

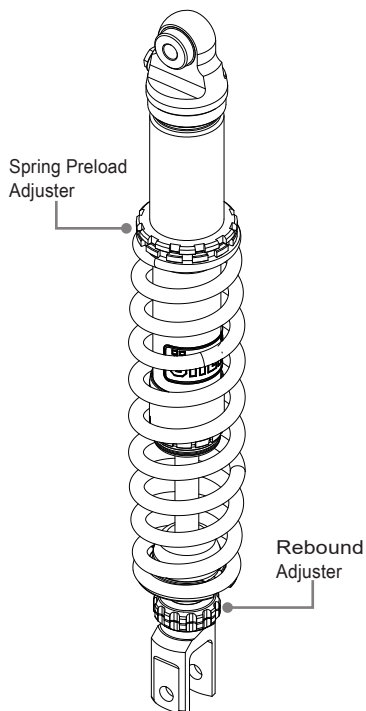

SET-UP DATA

Recommended set-up

Spring Preload..... 10 mm.
Rebound adjuster 16 Clicks

Shock absorber data

Length 460 mm.
Stroke 93 mm.

Spring	Installed spring	Alternative spring
Part No	60294-61	60294-62
Free spring length...	260 mm	260 mm
Spring rate.....	52 N/mm	60 N/mm
Preload adj.range....	[0-22] mm	[0-22] mm
For rider's weight....	Below 80 kg	Above 80 kg

👁 Öhlins products are subject to continuous improvement and development, therefore, although these instructions include the most up-to-date information available at the time of printing, minor updates may occur.

To find the latest information contact an Öhlins distributor. Please contact Öhlins if you have any questions regarding the contents in this document.

Part no. MI_KA008_EN_0
Issued 2020-07-14

© Öhlins Asia Co. Ltd. All rights reserved. Any reprinting or unauthorized use without the written permission of Öhlins Racing AB is prohibited.

Öhlins Asia Co. Ltd
700/937 Moo5, Tambol Nongkhaga,
Amphur Phantong, Chonburi Province
20160 Thailand



www.ohlins.com