

Note!

Before installing this product, check the contents of the kit. If anything is missing, please check an Öhlins dealer.

Kit Contents

Description	Part No	Pcs
Shock absorber	KA 738	1
Bracket reservoir 44	03102-15	1
Bracket reservoir	60006-19	1
Washer 6.3/10/1.2	60426-04	2
Screw M6x12	01046-36	2
Screw M6x30	01046-02	1
Screw M6x40	01046-09	1
Screw M6x14	00382-16	1
C-spanner S46	60710-02	1
Sticker set R&T "ÖHLINS"	10207-01	1
Owners manual road & track	07241-02	1

Note!

Please note that this image is a general representation of the product and may differ slightly from your product.

Note!

Please note that during storage and transportation, especially at high ambient temperature, some of the oil and grease used for assembling may leak and stain the packaging. This is in no way detrimental to the product, wipe off the excessive oil/grease with a cloth.

Warning!

Before installing this product, read the Öhlins Owner's Manual. The shock absorber is an important part of your vehicle and will affect the stability.

Shock Absorber for Kawasaki Z650

KA 738

Mounting Instructions



MOUNTING INSTRUCTIONS

⚠ Warning!

It is advisable to have an Öhlins dealer install the shock absorber.

⚠ Warning!

If working on a raised vehicle, ensure it is securely supported so that it will not tip over.

👁 Note!

Before mounting this product clean the vehicle thoroughly.

👁 Note!

When working on this product, always see the Vehicle Service Manual for vehicle specific procedures and important data.

1. Put the motorcycle on the work stand so that the rear wheel barely touches the ground. Make sure the motorcycle is in a stable position.

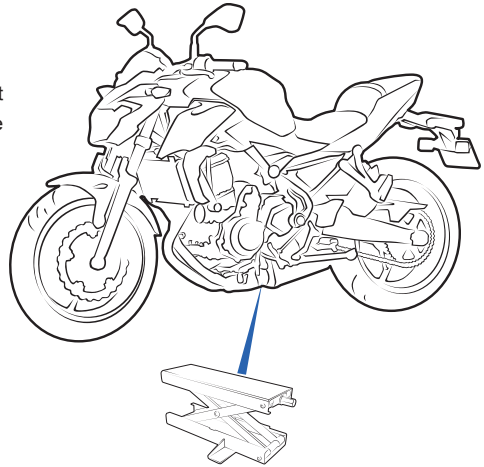

2. Remove the plastic fairing **A** by loosening the screws **1** **2** **3** **4** (**3** and **4** are on the opposite)

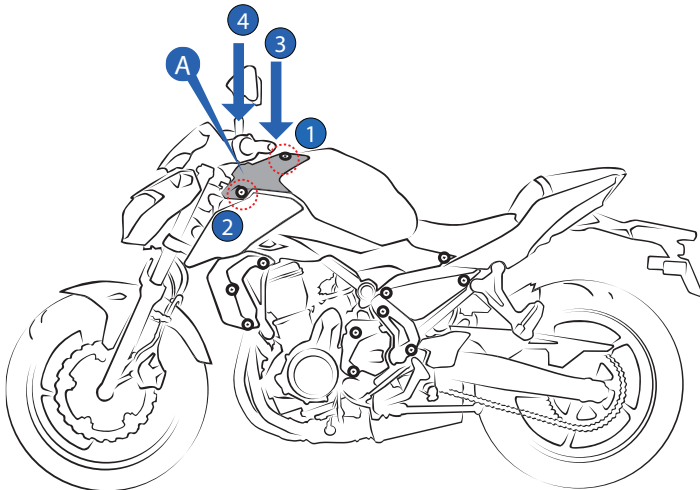

MOUNTING INSTRUCTIONS

3

Remove the fairings (B)(C)(D) as following :

- (B) : Remove the plastic push clips
① ② ③ ④
- (C) : Loosen the screws ⑤ ⑥ ⑦
- (D) : Loosen the screws ⑧

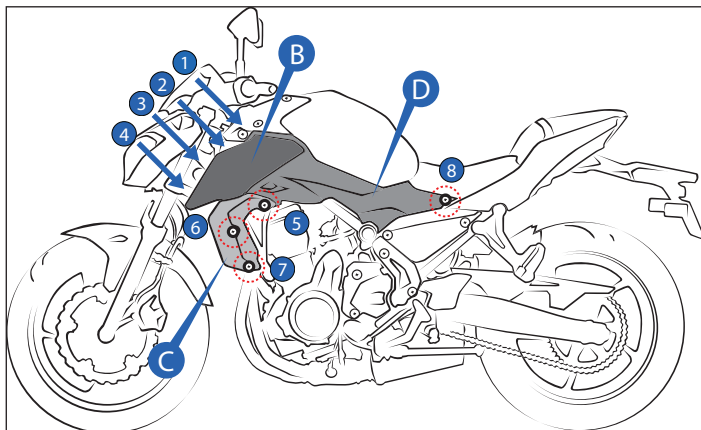

4

Remove the fairings (E)(F)(G) as following :

- (E) : Loosen the screws ① ②
- (F) : Loosen the screws ③ ④
- (G) : Loosen the screws ⑤ ⑥

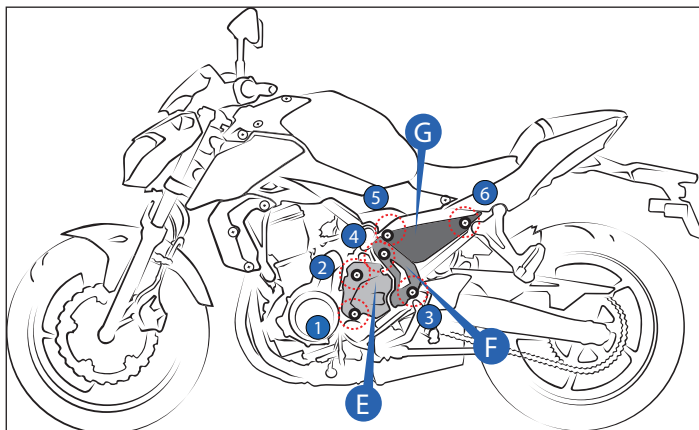

MOUNTING INSTRUCTIONS

5

Uninstall the standard shock absorber by loosening the upper and lower mounting screws ① ②

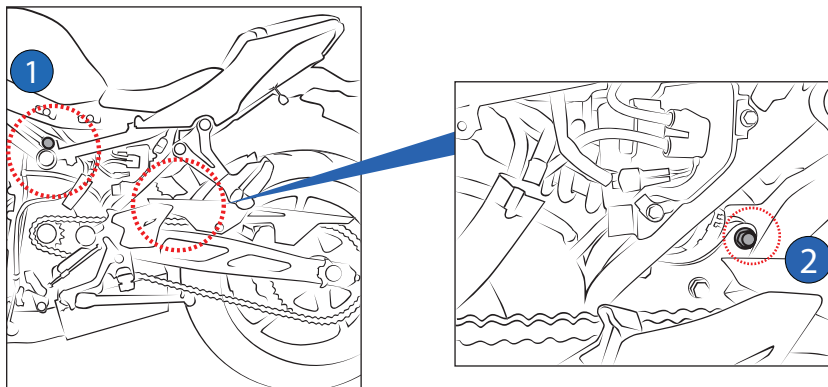

6.

Install the Öhlins shock absorber with the hose pointing downwards. Tighten the upper and lower mounting at a torque value as specified in the vehicle service manual.

7.

Fix the reservoir in position according to the installation diagram P1.

Reverse all procedures as necessary.

Note!

Lower the vehicle so that the suspension is slightly compressed before tightening the screws.

Caution!

Ensure that all screws are tightened to the correct torque and that nothing fouls or restricts movement of the shock absorber when the suspension is fully compressed or extended.

MOUNTING INSTRUCTIONS

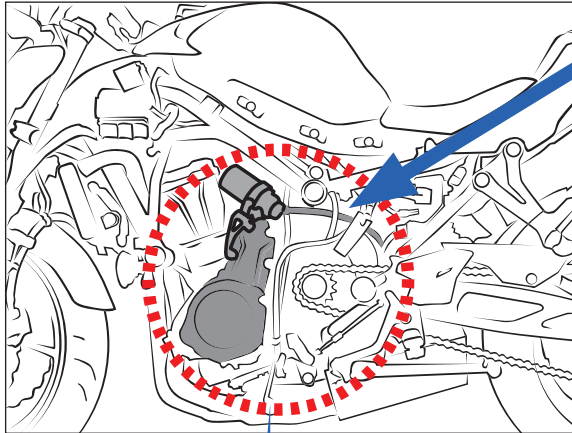

Rout the hose between the chassis and the cables.

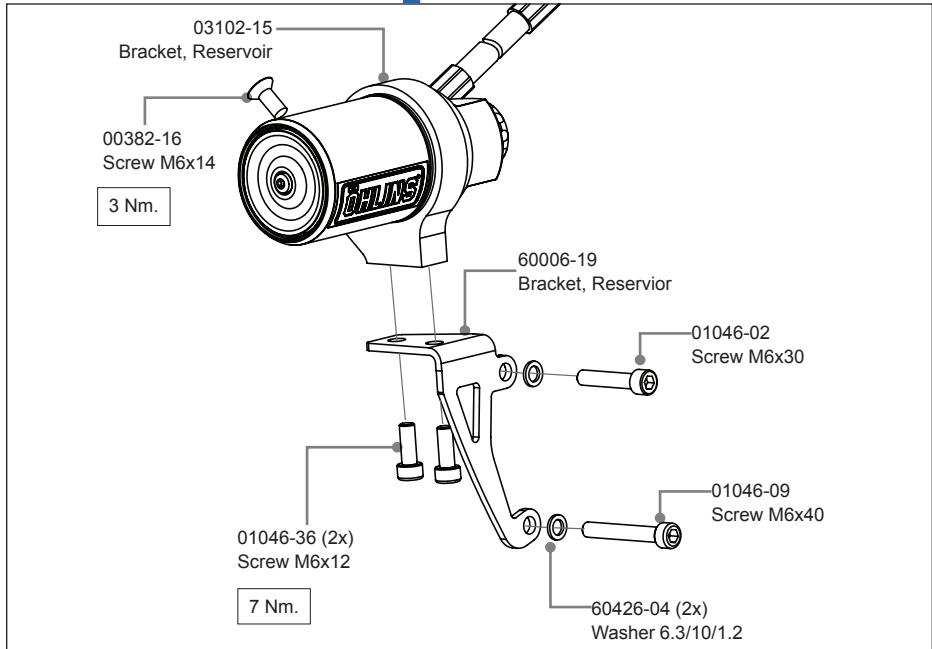

P1

This page intentionally left blank

This page intentionally left blank

ADJUSTMENTS

Warning!

Before riding, always make sure that the basic settings made by Öhlins are according to recommended Set-up Data. Read about adjustments and setting up in the Öhlins Owner's Manual before you make any adjustments. Contact an Öhlins dealer if you have any questions about setting up.

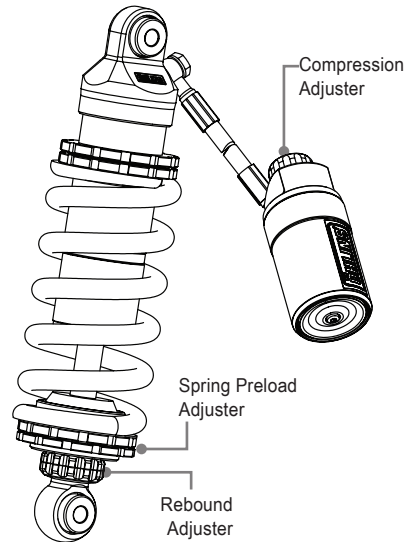

SET-UP DATA

Recommended set-up

Spring Preload.....	10 mm.
Compression adjuster	12 Clicks
Rebound adjuster	14 Clicks

Shock absorber data

Length	297 mm.
Stroke	54 mm.

Spring

Part No	61091-54
Free spring length	160 mm.
Spring rate	140 N/mm
Preload adj.range	[0-15] mm

 Öhlins products are subject to continuous improvement and development, therefore, although these instructions include the most up-to-date information available at the time of printing, minor updates may occur.

To find the latest information contact an Öhlins distributor. Please contact Öhlins if you have any questions regarding the contents in this document.

Part no. MI_KA 738_EN_0
Issued 2017-11-28

© Öhlins Asia Co. Ltd. All rights reserved. Any reprinting or unauthorized use without the written permission of Öhlins Racing AB is prohibited.

Öhlins Asia Co. Ltd
700/937 Moo5, Tambol Nongkhaga,
Amphur Phantong, Chonburi Province
20160 Thailand



www.ohlins.com