

**Note!**

*Before installing this product, check the contents of the kit. If anything is missing, please check an Öhlins dealer.*

**Kit Contents**

Description	Part No	Pcs
Shock absorber	HO 913	1
C-spanner S46	60710-02	1
Bracket	60006-24	1
Bracket reservoir	03102-15	1
Screw M6x14	00382-16	1
Screw M6x12	05404-01	2
Protection film	60191-57	2
Sticker set	10207-01	1
Owners manual road & track	07241-02	1

**Note!**

*Please note that this image is a general representation of the product and may differ slightly from your product.*

**Note!**

*Please note that during storage and transportation, especially at high ambient temperature, some of the oil and grease used for assembling may leak and stain the packaging. This is in no way detrimental to the product, wipe off the excessive oil/grease with a cloth.*

**Warning!**

*Before installing this product, read the Öhlins Owner's Manual. The shock absorber is an important part of your vehicle and will affect the stability.*

## Shock Absorber for Honda CBR/CB650R

# HO 913

## Mounting Instructions

# MOUNTING INSTRUCTIONS

## **Warning!**

It is advisable to have an Öhlins dealer install the shock absorber.

## **Warning!**

If working on a raised vehicle, ensure it is securely supported so that it will not tip over.

## **Note!**

Before mounting this product clean the vehicle thoroughly.

## **Note!**

When working on this product, always see the Vehicle Service Manual for vehicle specific procedures and important data.

1.

Put the motorcycle on a work stand so that the rear wheel barely touches the ground. Make sure the motorcycle is in a stable position.

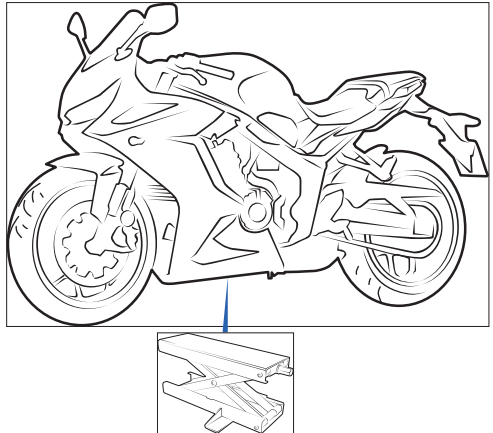

2.

Loosen the screws ① ② on right side and ③ ④ on left side in order to remove the chainguard and mudguard **A**.

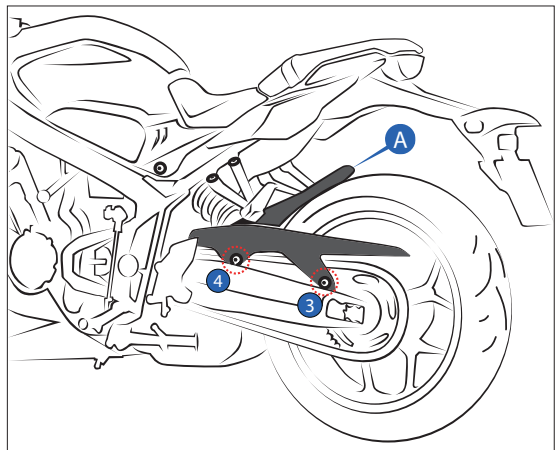
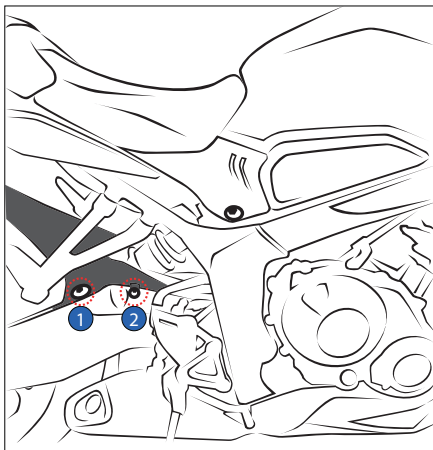

# MOUNTING INSTRUCTIONS

3.

Remove the passenger seat (B) by using the key unlock and remove the rider seat (C) by loosening its 2 screws.

3.1

Loosen the screw (1) in order to remove the cover (D) on both side of the motorcycle.

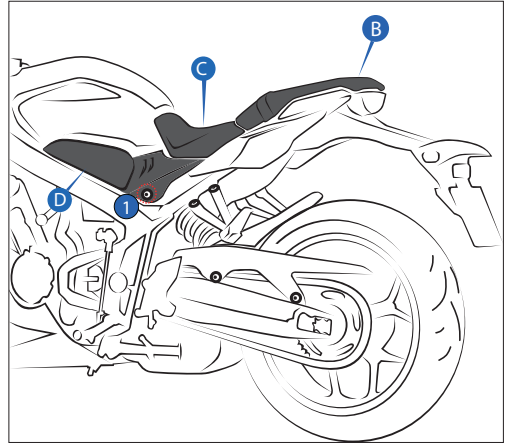

4.

Loosen the screws (1) (2) in order to remove the foot peg (E).

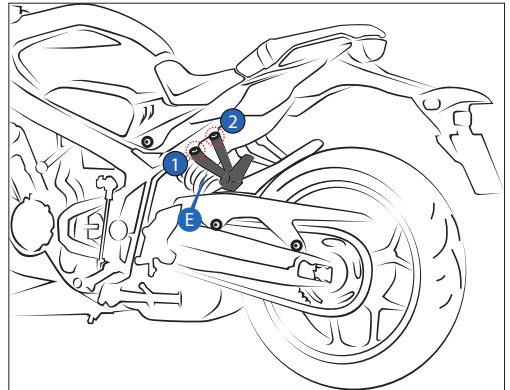

5.

Remove the standard shock absorber by loosening the upper and lower mounting bolts (1) (2).

5.1

Install the Öhlins shock absorber by tightening the upper and lower mounting bolts (1) (2).

Tighten at a torque value as specified in the vehicle service manual.

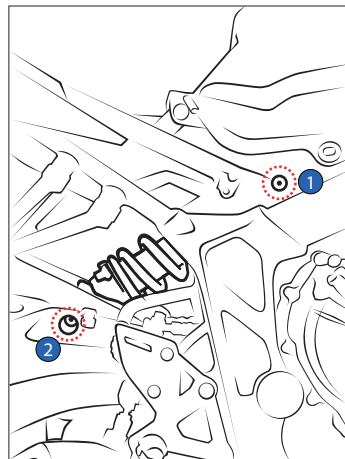

# MOUNTING INSTRUCTIONS

6.

Install the reservoir clamp bracket (F) onto the metal bracket (G) by using the 2 screws M6x12.

6.1

Slide the reservoir (H) into the clamp bracket (F). Do not tighten it yet.

6.2

Tighten the metal bracket (G) in between the rear sub-frame and the foot peg.

6.3

Adjust the reservoir and hose position so that the hose is not touching any motorcycle parts.

6.4

Lock the reservoir by tightening the clamp bracket (F) by using the screw M6x14.

In the eventuality that the reservoir hose touches parts of the motorcycle frame, use the transparent sticker 60191-57 for protecting the surfaces against wear.

Reverse all the procedure as necessary.

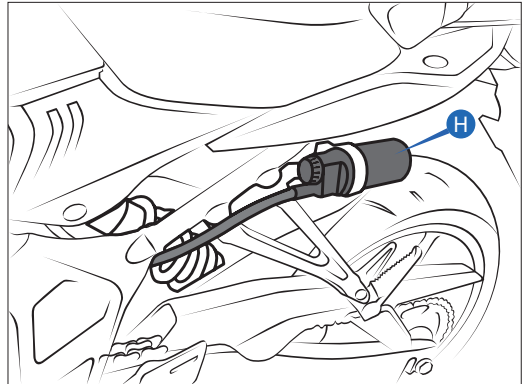
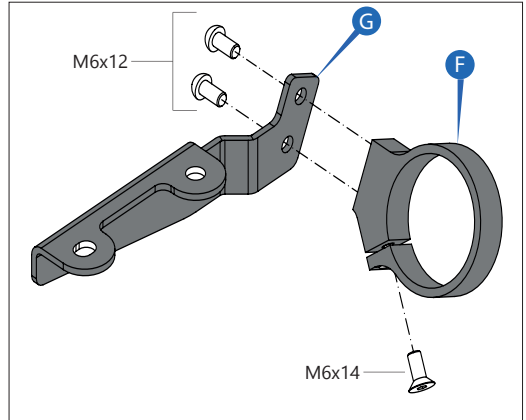

## Note!

*Lower the vehicle so that the suspension is slightly compressed before tightening the screws.*

## Caution!

*Ensure that all screws are tightened to the correct torque and that nothing fouls or restricts movement of the shock absorber when the suspension is fully compressed or extended.*

# MOUNTING INSTRUCTIONS

Page intentionally left blank

# MOUNTING INSTRUCTIONS

Page intentionally left blank

# MOUNTING INSTRUCTIONS

Page intentionally left blank

# ADJUSTMENTS

## **Warning!**

*Before riding, always make sure that the basic settings made by Öhlins are according to recommended Set-up Data. Read about adjustments and setting up in the Öhlins Owner's Manual before you make any adjustments. Contact an Öhlins dealer if you have any questions about setting up.*

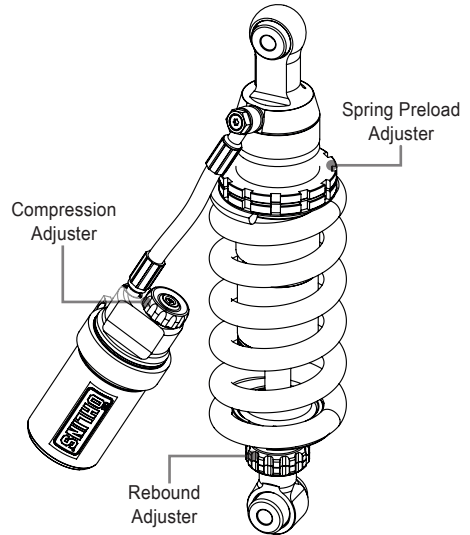

## SET-UP DATA

### Recommended set-up

Spring Preload.....	8 mm.
Compression adjuster .....	16 Clicks
Rebound adjuster .....	16 Clicks

### Shock absorber data

Length .....	332 mm.
Stroke .....	52 mm.

### Spring

Part No .....	01092-84
Free spring length...	170 mm.
Spring rate .....	200 N/mm
Preload adj.range ...	[3-15] mm

 Öhlins products are subject to continuous improvement and development, therefore, although these instructions include the most up-to-date information available at the time of printing, minor updates may occur.

To find the latest information contact an Öhlins distributor. Please contact Öhlins if you have any questions regarding the contents in this document.

Part no. MI\_HO913\_EN\_0  
Issued 2019-06-23

© Öhlins Asia Co. Ltd. All rights reserved. Any reprinting or unauthorized use without the written permission of Öhlins Racing AB is prohibited.

Öhlins Asia Co. Ltd  
700/937 Moo5, Tambol Nongkhaga,  
Amphur Phantong, Chonburi Province  
20160 Thailand



[www.ohlins.com](http://www.ohlins.com)