

### 👁 Note!

Before installing this product, check the contents of the kit. If anything is missing, please contact an Öhlins dealer

### Kit Contents

Description	Part No	Pcs
Shock absorber	HO 703	1
Reservoir bracket plastic	05378-10	1
Reservoir bracket	60006-02	1
Nut M5	00430-04	3
Screw M5x12	01046-34	2
Screw M5x20	01046-55	1
Sticker set "ÖHLINS"	10207-01	1
C-spanner S46	60710-02	1
Owners manual road & track	07241-02	1
Alternative components		
Spring 57/250/70 N/mm	60012-15	1

### 👁 Note!

Please note that this image is a general representation of the product and may differ slightly from your product.

### 👁 Note!

Please note that during storage and transportation, especially at high ambient temperature, some of the oil and grease used for assembling may leak and stain the packaging. This is in no way detrimental to the product, wipe off the excessive oil/grease with a cloth.

### ⚠ Warning!

Before installing this product, read the Öhlins Owner's Manual. The shock absorber is an important part of your vehicle and will affect the stability.

## Shock Absorber for Honda CRF250Rally

# HO 703

## Mounting Instructions



# MOUNTING INSTRUCTIONS

## **⚠ Warning!**

*It is advisable to have an Öhlins dealer install the shock absorber.*

## **⚠ Warning!**

*If working on a raised vehicle, ensure it is securely supported so that it will not tip over.*

## **👁 Note!**

*Before mounting this product clean the vehicle thoroughly.*

## **👁 Note!**

*When working on this product, always see the Vehicle Service Manual for vehicle specific procedures and important data.*

## **👁 Note!**

*Must remove the engine guard before put the motorcycle on a work stand.*

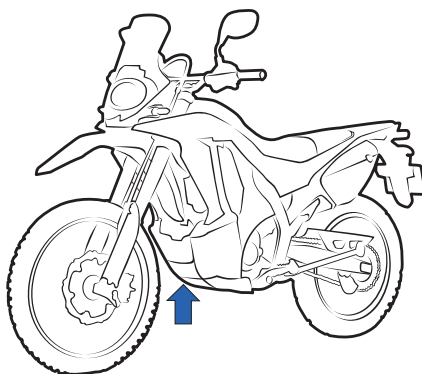

- 1 Remove the engine front guard by removing the 4 screws.

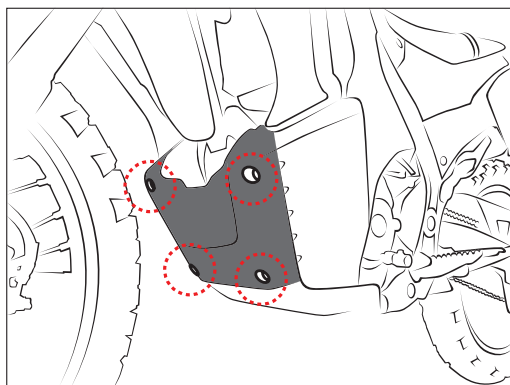
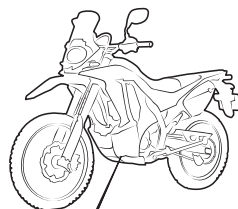

# MOUNTING INSTRUCTIONS

2

Remove the engine bottom guard by removing the 2 screws.

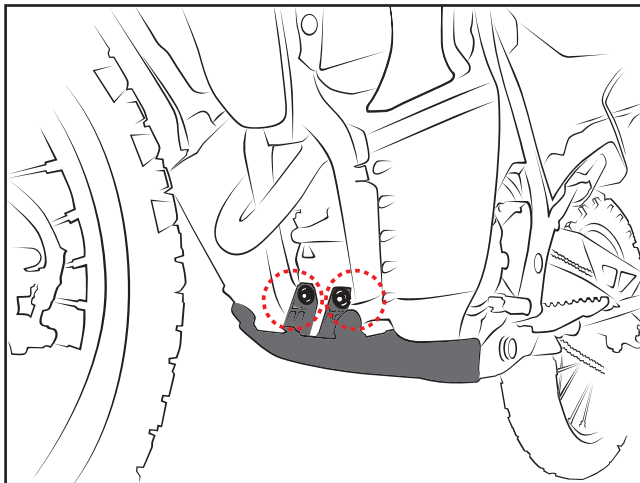
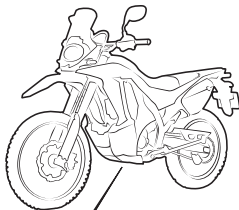

3

Put the motorcycle on a work stand so that the rear wheel barely touches the ground. Make sure the motorcycle is in a stable position.

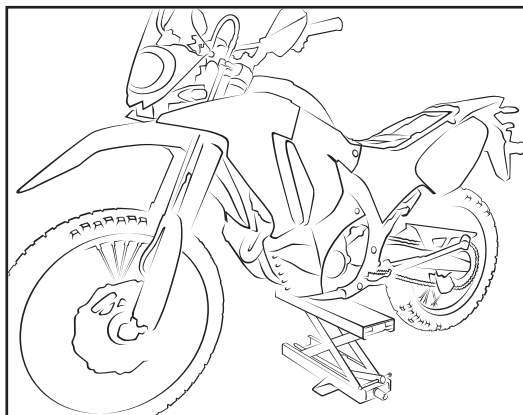

# MOUNTING INSTRUCTIONS

4

Remove the rider seat by removing 2 bolts.

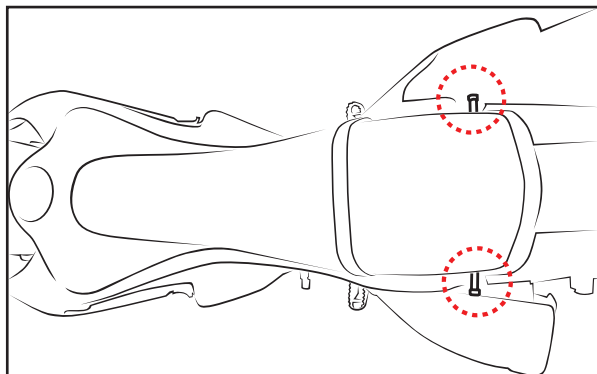

5

On RH side : use the ignition key (1) to unlocking the rear fairing, then remove the 6 screws to remove the side fairing.

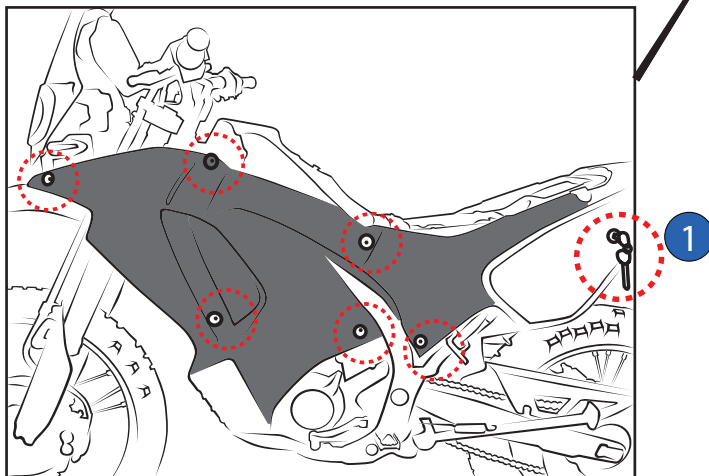
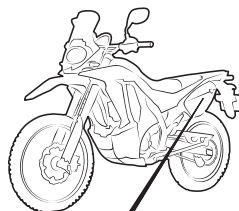

# MOUNTING INSTRUCTIONS

6

On LH side : remove the rear fairing by removing the 2 screws.

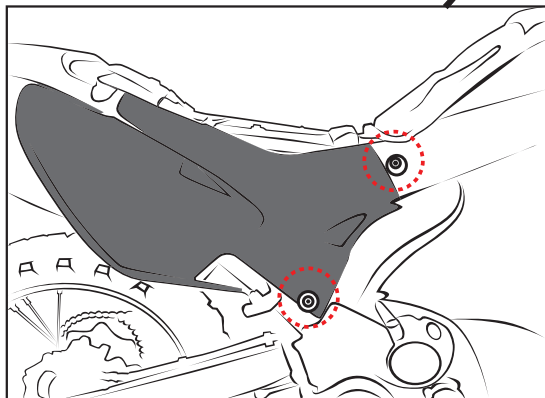
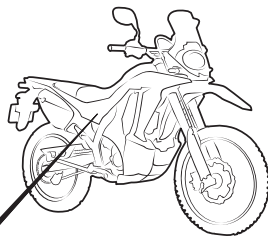

7

Move the brake fluid reservoir, by removing the screw, for access to the shock absorber upper mounting point.

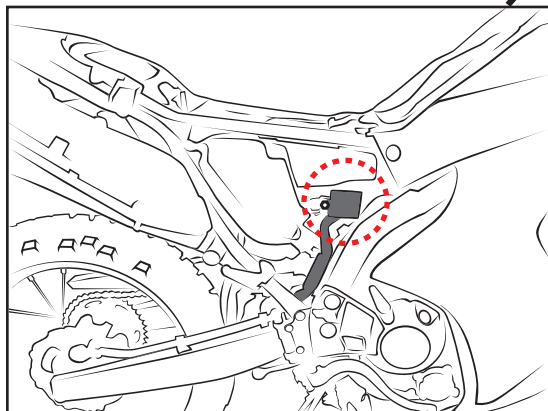
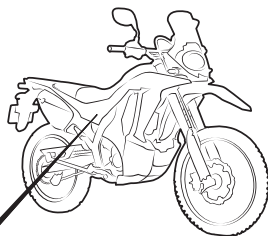

# MOUNTING INSTRUCTIONS

- 8  
Remove the shock absorber upper mounting bolt.

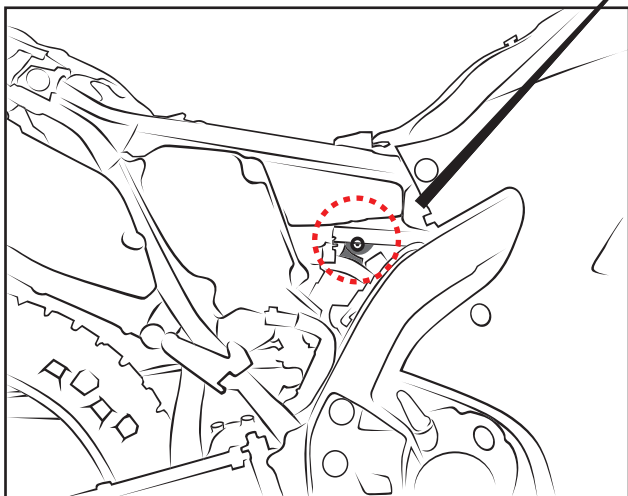
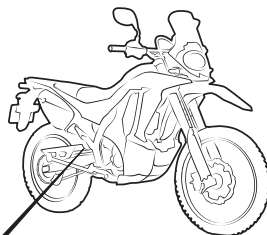

- 9  
Remove the bolts (1) and (2) from the linkage and shock.

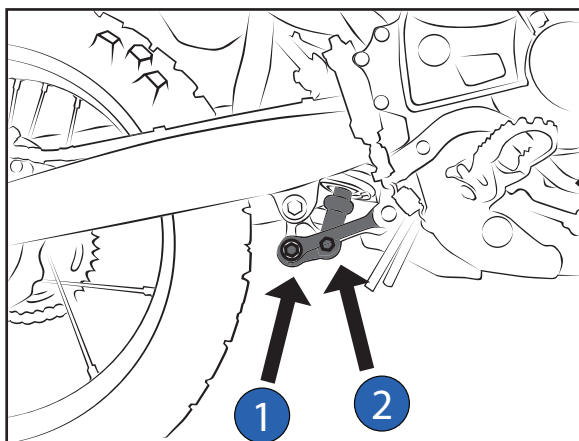
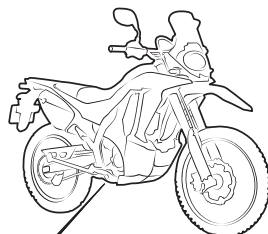

# MOUNTING INSTRUCTIONS

10

On LH side : remove the chain cover, by removing the 2 screws (1), (2) .

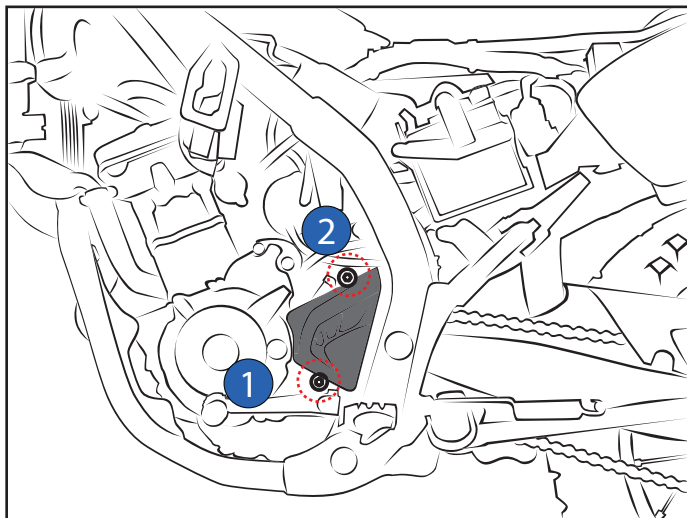
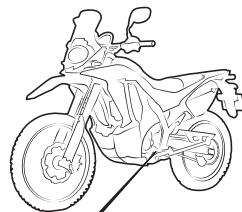

11

Remove the 2 screws and reposition the sprocket to allow the reservoir to pass between the engine and frame.

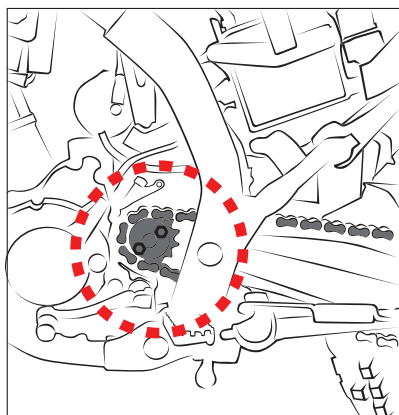

# MOUNTING INSTRUCTIONS

12

Install the Öhlins shock absorber, use the original bolts (1),(2) and tighten to the torque value recommended by the manufacturer.

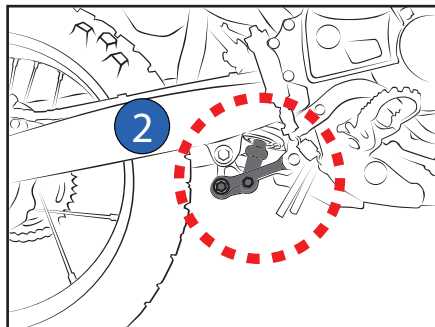

13

Slide the reservoir between the frame and the engine as shown in diagram P13

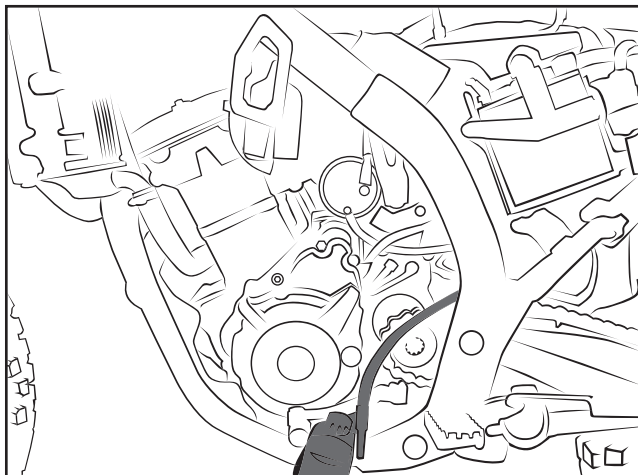

P 13



# MOUNTING INSTRUCTIONS

14

14.1

Assemble the brackets 60006-02 and 05378-10 using the fasteners provided see diagram P14.1

14.2

Insert the reservoir in to the bracket, do not tighten yet for easy to arrange the positioning as diagram P14.2

14.3

Install the bracket set to the engine cover by using with the original screws see diagram below.

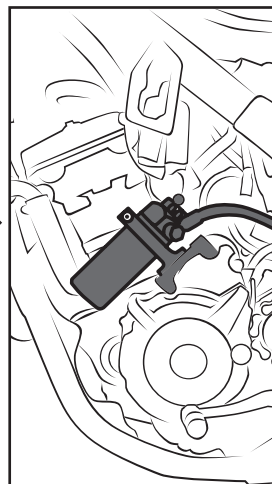
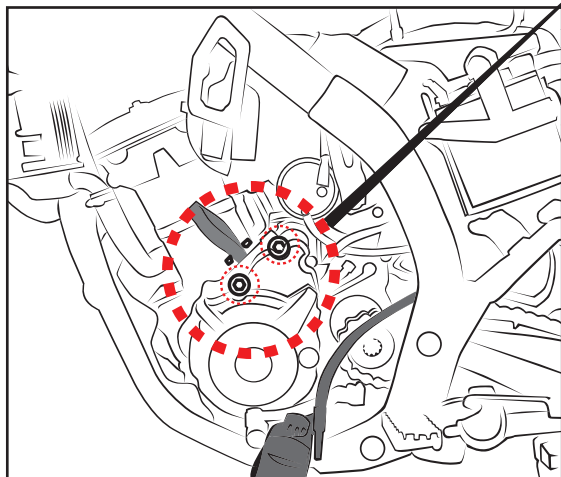
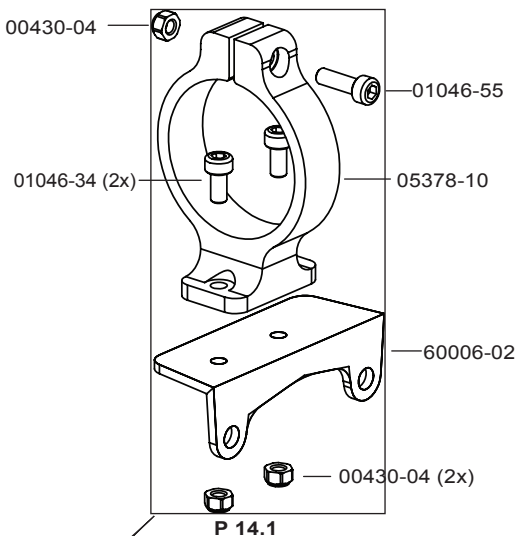

# MOUNTING INSTRUCTIONS

15

Ensure that hose is not touching any part of the motorcycle. Then tighten the bolt. Refit all the parts in reverse order.

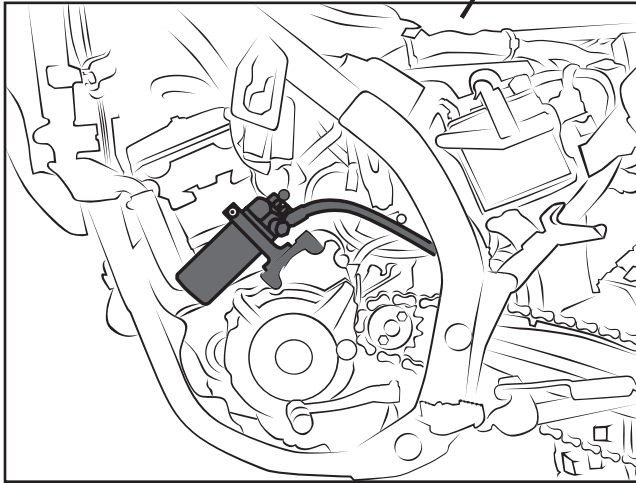
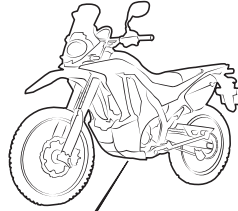

 **Note!**

*Lower the vehicle so that the suspension is slightly compressed before tightening the screws.*

 **Caution!**

*Ensure that all screws are tightened to the correct torque and that nothing fouls or restricts movement of the shock absorber when the suspension is fully compressed or extended.*



# ADJUSTMENTS

## ⚠ Warning!

Before riding, always make sure that the basic settings made by Öhlins are according to recommended Set-up Data. Read about adjustments and setting up in the Öhlins Owner's Manual before you make any adjustments. Contact an Öhlins dealer if you have any questions about setting up.

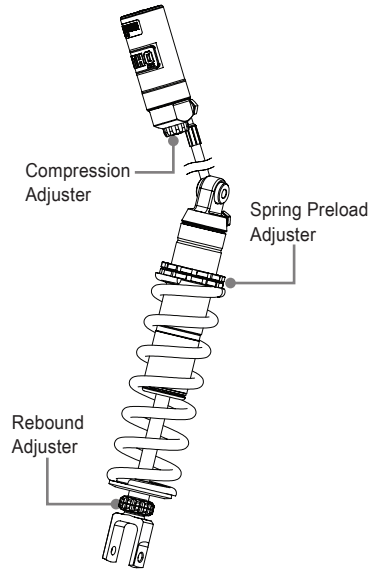

# SET-UP DATA

### Recommended set-up

Spring Preload ..... 10 mm  
 Rebound adjuster ..... 20 Clicks  
 Compression adjuster. 12 Clicks

### Spring

Part No ..... 60012-14  
 Free spring length ..... 250 mm  
 Spring rate..... 64 N/mm  
 Preload adj.range..... [0-23] mm

### Shock absorber data

Length ..... 421 mm  
 Stroke ..... 102 mm

### Recommended spring

Spring part No.	Spring rate	For rider weight
60012-14	64 N/mm	Below 80 kg
60012-15	70 N/mm	Above 80 kg

👁 Öhlins products are subject to continuous improvement and development, therefore, although these instructions include the most up-to-date information available at the time of printing, minor updates may occur.

To find the latest information contact an Öhlins distributor. Please contact Öhlins if you have any questions regarding the contents in this document.

Part no. MI\_HO703 EN\_0  
 Issued 2017-20-03

© Öhlins Asia Co. Ltd. All rights reserved. Any reprinting or unauthorized use without the written permission of Öhlins Asia Co.,Ltd is prohibited.

Öhlins Asia Co. Ltd  
 700/937 Moo5, Tambol Nongkhaka,  
 Amphur Phantong, Chonburi Province  
 20160 Thailand



[www.ohlins.com](http://www.ohlins.com)