

BF12

Flangia Specifica per borse Tanklock - Specific Carrier for Tanklock bags
Brides spécifiques pour Tanklock bagagerie souple - Tankringen für tanklock Weichtaschen
Aro específico para bolsas Tanklock - Anel específico para sacos Tanklock

N°	Descrizione	Caratteristiche	Codice	Quantità
1	Flangia - Support Brides - Tankringen Aro - Anel	-	GL2017	2 (Dx;Sx)
2	Supporto - Support Support - Halterung Soporte - Suporte	-	ZT480F	-
3	Vite - Screw Vis - Schraube Tornillo - Parafuso	TBEI M8x50	540TBEI	3
4	Vite - Screw Vis - Schraube Tornillo - Parafuso	TBEI M6x25	525TBEI	3
5	Dado - Bolt - Ecrou Mutter - Tuerca - Porca	Dado Auto Bloccante Flangiato M5	5DADIAFL	3

BF12

Flangia Specifica per borse Tanklock - Specific Carrier for Tanklock bags
Brides spécifiques pour Tanklock bagagerie souple - Tankringen für tanklock Weichtaschen
Aro específico para bolsas Tanklock - Anel específico para sacos Tanklock

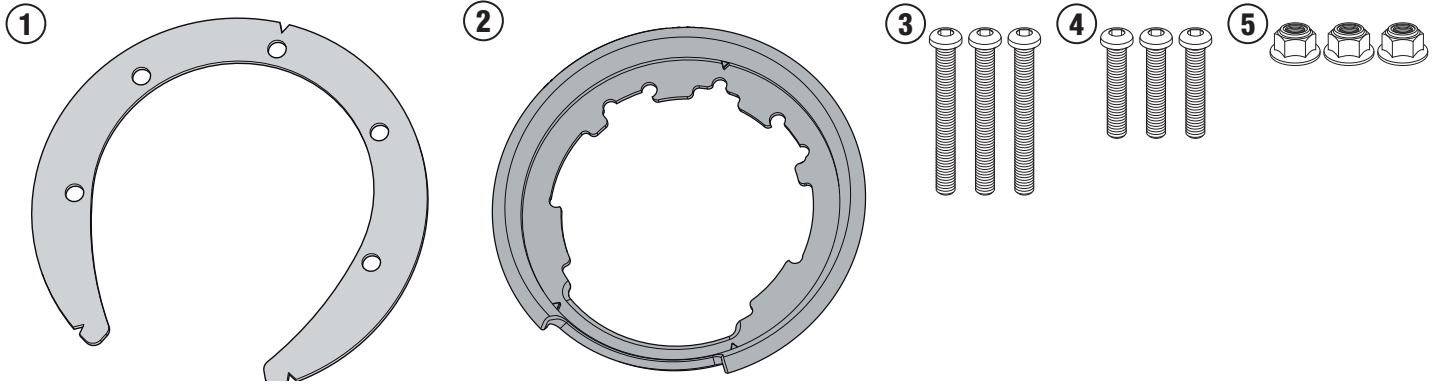

NUOVO MODELLO
NEW MODEL
NOUVEAU MODÈLE
NEUES MODELL
NUEVO MODELO

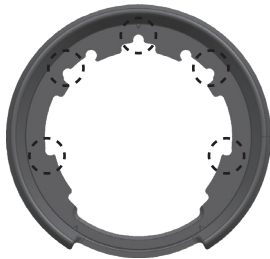

VECCHIO MODELLO
OLD MODEL
ANCIEN MODÈLE
ALTES MODELL
VIEJO MODELO

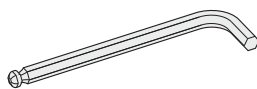
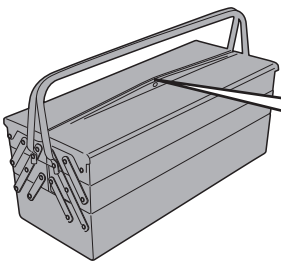
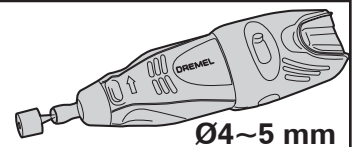
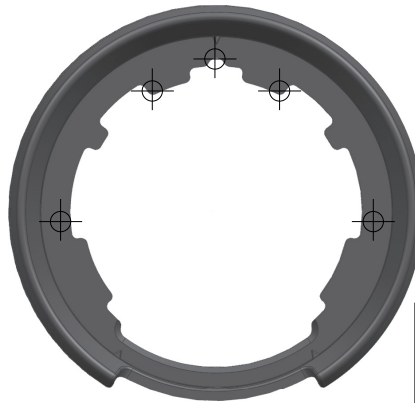
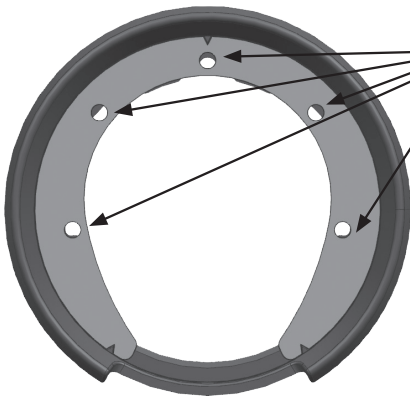
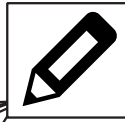
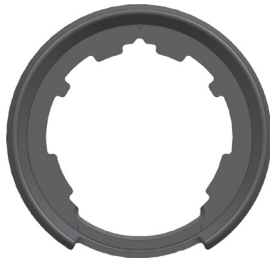

3mm



BF12

Flangia Specifica per borse Tanklock - Specific Carrier for Tanklock bags
Brides spécifiques pour Tanklock bagagerie souple - Tankringen für tanklock Weichtaschen
Aro específico para bolsas Tanklock - Anel específico para sacos Tanklock

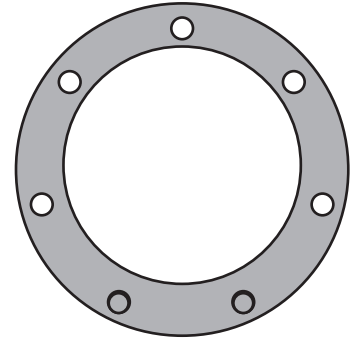
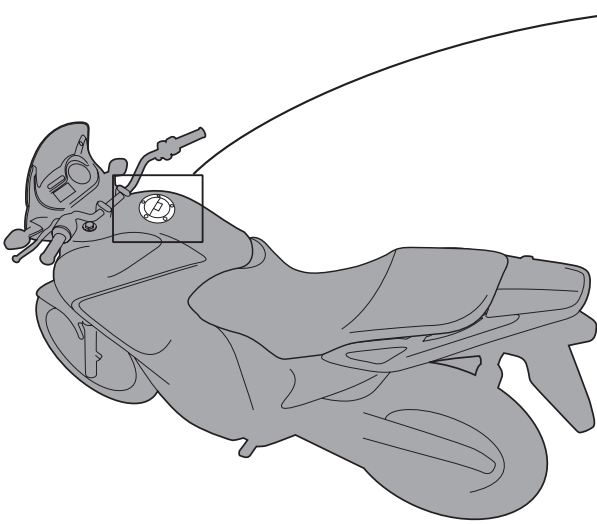

Rimuovere le viti originali
Remove the original screws
Enlevez les vis originales
Entfernen Sie die Originalschrauben
Mover los tornillos originales
Mova os parafusos originais

TOGLIERE
REMOVE
ENLEVER
ENTFERNEN
QUITAR
REMOVER

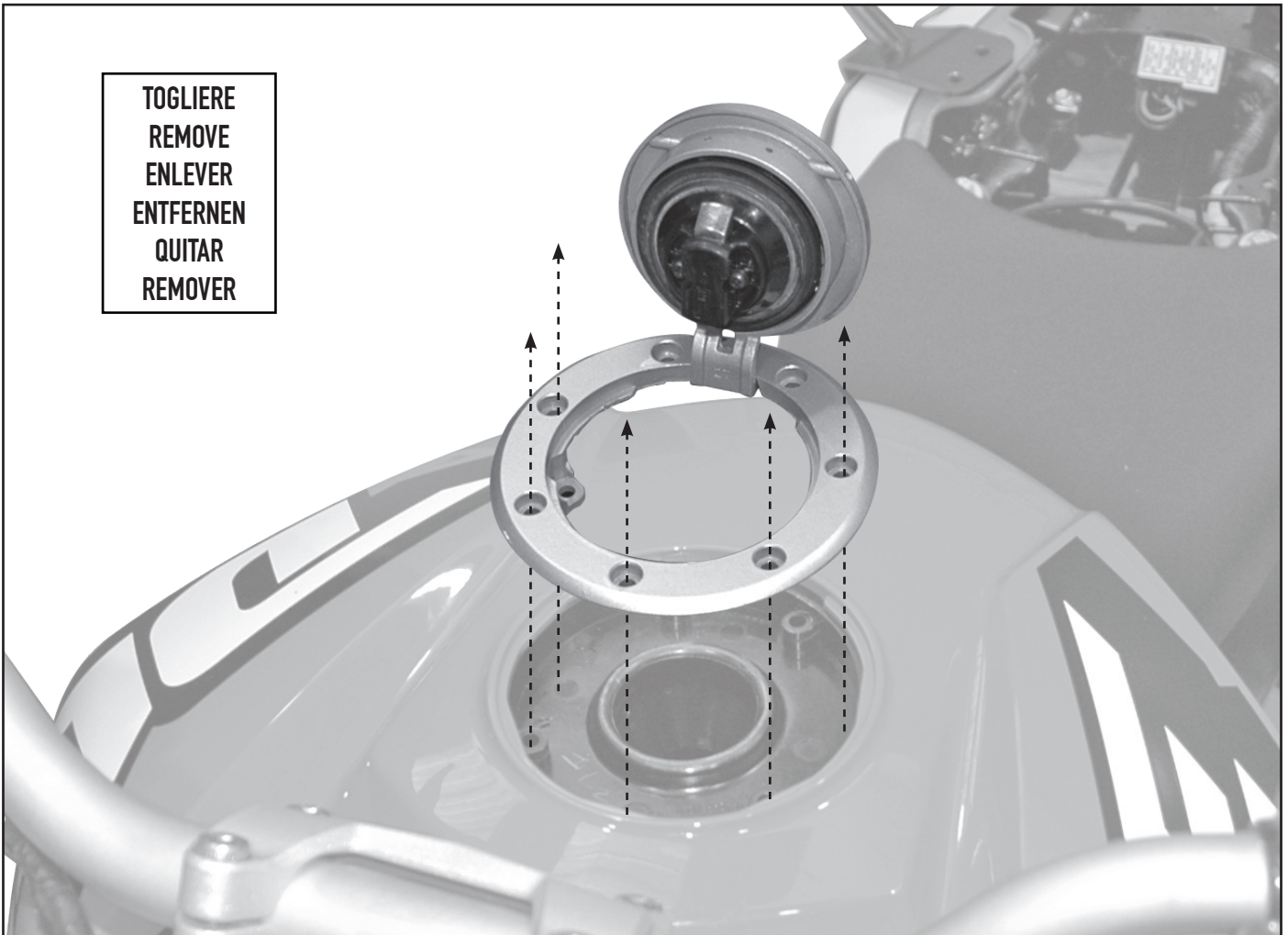

BF12

Flangia Specifica per borse Tanklock - Specific Carrier for Tanklock bags
Brides spécifiques pour Tanklock bagagerie souple - Tankringen für tanklock Weichtaschen
Aro específico para bolsas Tanklock - Anel específico para sacos Tanklock

OLD TYPE

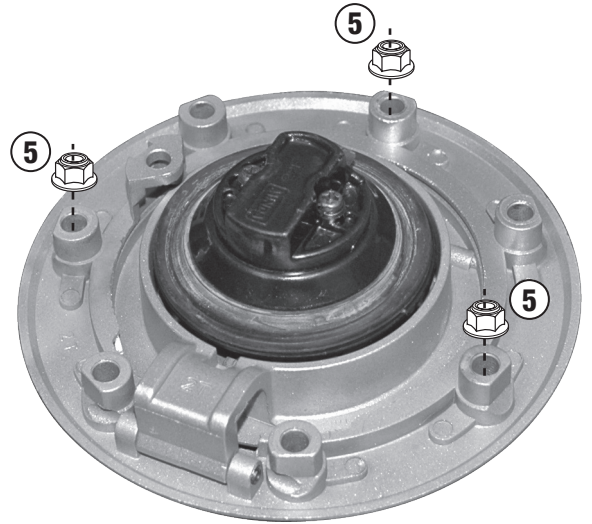
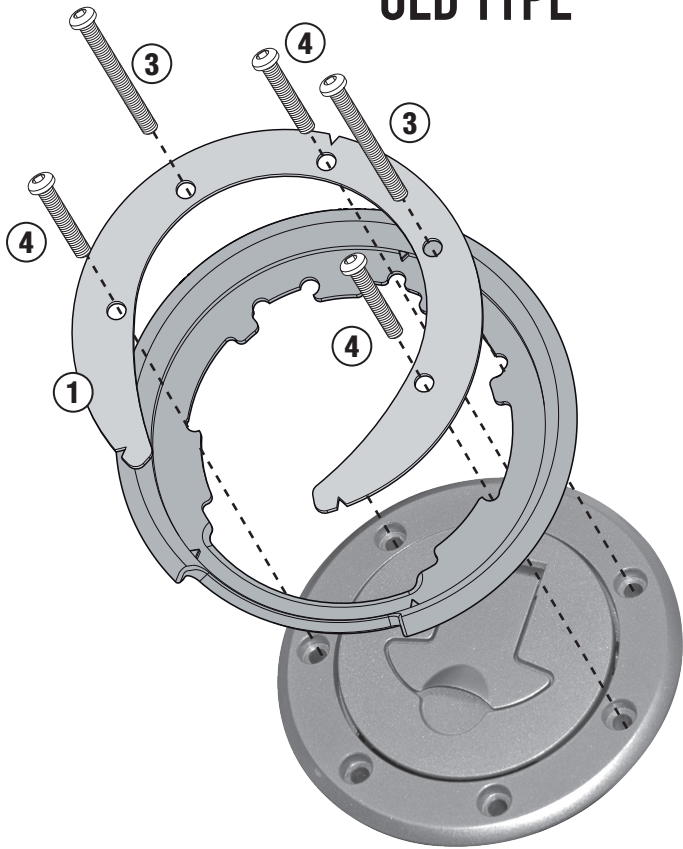

NEW TYPE

