

1

2

3

4

Drawn
Deponti
Checked
Caronia



BRAKE DISC KIT DP $\phi 310$

208.9737.70 □
Date 26.08.24

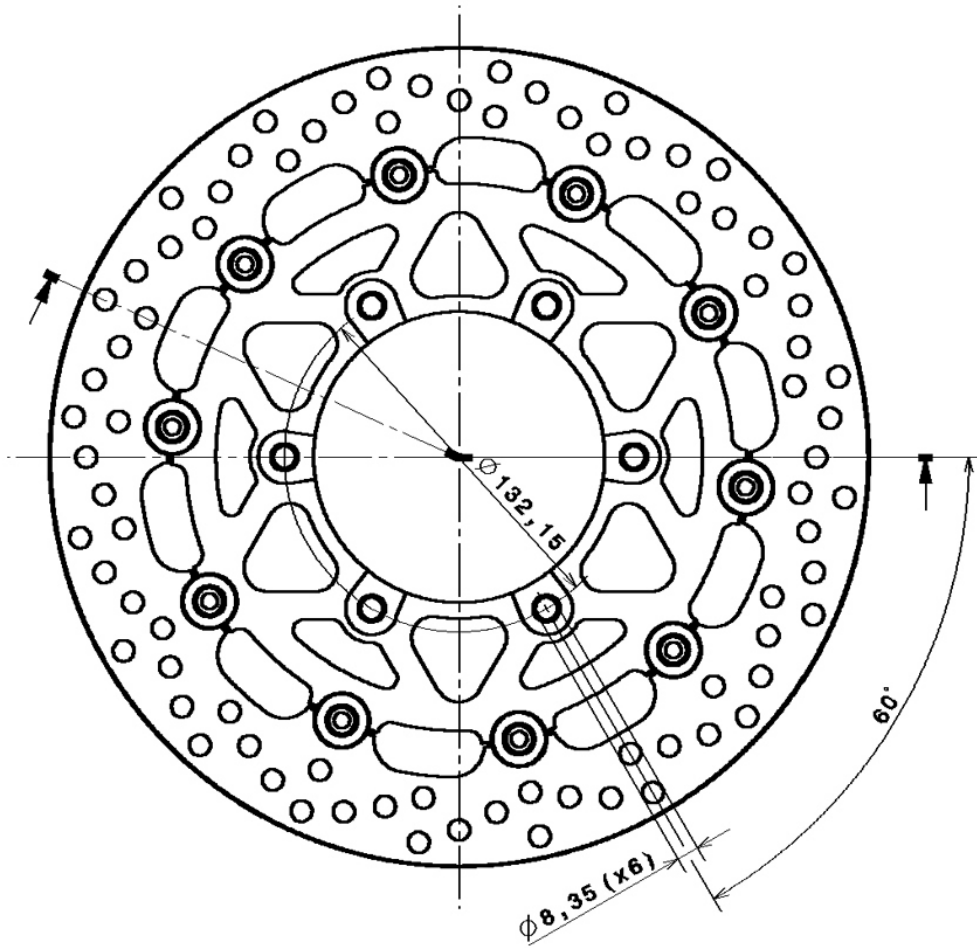
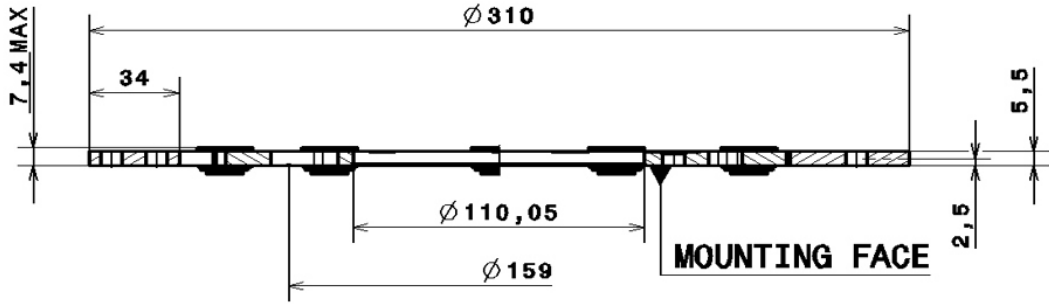

ITEMS INSIDE THE KIT

DESCRIPTION

QTY

BRAKE DISC DP 310x5,5

2

INSTRUCTION SHEET

1

BREMBO SMALL STICKER

2

DRAWING CHANGES
A Pos
- FIRST RELEASE ##.##.##
Deponti

A
B
C
D
E
F