



Installation instructions

Akrapovič Exhaust Systems
Evolution
for the
Aprilia RSV4



504734

Congratulations on purchasing an Akrapovič exhaust system. Please read the entire installation manual prior to undertaking any activities related to installation of your new Akrapovič exhaust system. In case you do not fully understand the manual or any of its parts, please contact your authorized dealer!

This product should be installed by someone with sufficient knowledge of exhaust systems and their installation, and appropriate hand or power tools. If you are not qualified for this work, please utilize a certified mechanic for installation. By installing Your Akrapovič exhaust system, you indicate that you have read the installation manual in its entirety and you agree with the terms stated herein.

It is your responsibility to follow all installation instruction guidelines supplied with the Akrapovič exhaust system and undertake all necessary safety precautions. Akrapovič d.d. assumes no responsibility for damages occurring from misuse, abuse, improper installation, improper operation, lack of responsible care, or all previously stated reasons resulting from incompatibility with other manufacturer's products and/or systems.

IMPORTANT INFORMATION

Exclusion of Certain Liability

1. The manufacturer, importer or dealer shall not be liable for any incidental damage including personal injury or any other damages caused by improper installation or operation of the Akrapovič exhaust system. When installing the Akrapovič exhaust system be careful that the exhaust system does not touch other parts sensitive to high temperature.
2. Akrapovič makes no representation or warranties with regard to damage caused by the improper installation, use and maintenance of the Akrapovič exhaust system. The warranty is limited to defects recognized by our technical department and due to normal use, and excludes items subject to normal wear (gaskets and damping wool). The guarantee is void in case of accident, modification, improper or competition use.
3. Do not attempt to install the Akrapovič exhaust system on a vehicle model for which it was not made or tested by Akrapovič.
4. When the exhaust system gets very hot during operation, be careful not to burn yourself on the exhaust system or parts which are in direct contact with it, even when the engine is not running. Also protect other people, especially children, from the injuries mentioned above.
5. In some cases Akrapovič exhaust system kits contain chemical products (ceramic anti-seizing grease; bolt sealant). Handle with care, do not inhale or swallow. Avoid excessive contact with skin, eyes or mucous membranes. Keep out of reach of children.
6. Technical specifications of Akrapovič exhaust systems and related products are subject to change without notice.
7. Before removing the original exhaust system from your vehicle, please compare the parts you received with the list of materials provided in the installation manual in order to assure that you have all the parts necessary for the installation of your new Akrapovič exhaust system.
8. Although this manual consists of instructions for installation in written form, as well as photographs and pictures representing individual steps of the installation, please note that the photographs and pictures are symbolic and are intended for representation of general overview only. The photographs and pictures contained herein should serve as a guideline only and actual installation of the exhaust system may not correspond with the photographs and pictures entirely.
9. The process of uninstalling the original exhaust system may vary depending on the existing exhaust system. Please follow the original exhaust system manufacturer's instructions for uninstalling the original exhaust system.

Trademarks

The Akrapovič trademark, including corporate logos and emblems, are subject to copyright as well as trademark rights of Akrapovič, its licensors or third persons authorizing Akrapovič to use them.

Akrapovič website

Information about Akrapovič exhaust systems and related products is available on the Akrapovič website at: <http://www.akrapovic.com/>

Copyright

No part of the Akrapovič exhaust system or its documentation may be reproduced or distributed in any form or by any means without the prior written authorization of the Akrapovič company.

Symbols

The following symbols are used throughout these installation instructions:



TOOLS REQUIRED



TIGHTENING TORQUE



INSTALLATION TIP



CAUTION OR WARNING



USE BOLT SEALANT; Apply 3 to 4 small drops of bolt sealant onto the cleaned and degreased threads before tightening the bolts. **WARNING! Avoid contact with skin, eyes and mucous membranes. Do not inhale fumes. Keep out of reach of children.**



USE ANTI-SEIZE LEAD-FREE COPPER PASTE (black tube); Provides trouble-free and long-lasting protection against seizing, corrosion and rusting of bolts, threaded ends, nuts, joints, etc. Also protects against vibration, wear and impact. **WARNING! Avoid eye contact. Avoid excessive skin contact. Keep out of reach of children.**



USE ANTI-SEIZING GREASE (white tube); Prevents seizing, corrosion and excessive wear between the titanium components of your exhaust system. **WARNING! Avoid eye contact. Avoid excessive skin contact. Keep out of reach of children.**

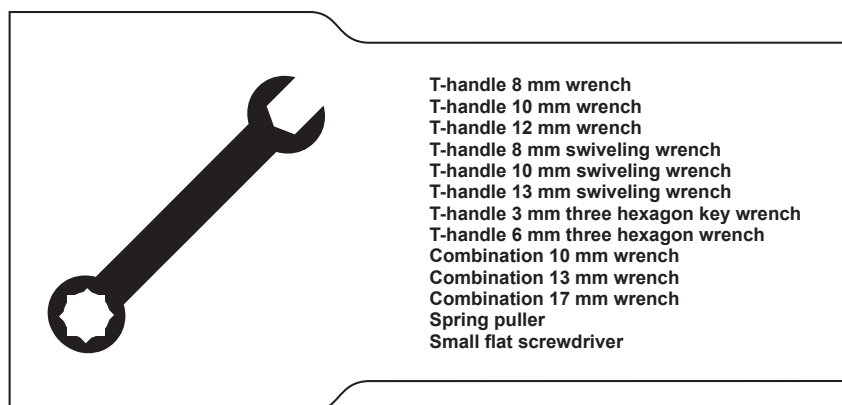

BEFORE INSTALLING, CHECK THE PARTS LIST AND SCHEMATIC DRAWING OF THE EXHAUST SYSTEM! THE LATEST VERSION OF THE PARTS LIST AND SCHEMATIC DRAWINGS OF THE PRODUCTS ARE AVAILABLE ON OUR WEB PAGE.



IF ANY ITEMS IN THE AKRAPOVIČ EXHAUST SYSTEM PACKAGE ARE MISSING, PLEASE CONTACT YOUR AUTHORIZED DEALER. KEEP THE SCHEMATIC FOR FUTURE REFERENCE.



THESE INSTALLATION INSTRUCTIONS MUST BE READ CAREFULLY IN ORDER TO ENSURE PROPER INSTALLATION AND OPERATION OF THE AKRAPOVIČ EXHAUST SYSTEM.



THE EXHAUST SYSTEM CAN BE EXTREMELY HOT. ALLOW THE EXHAUST AND ENGINE TO COOL DOWN BEFORE BEGINNING INSTALLATION.



WE ADVISE YOU TO LEAVE INSTALLATION TO A QUALIFIED SERVICEMAN. IMPROPER INSTALLATION MAY RESULT IN A SHORTER LIFETIME OF THE EXHAUST SYSTEM AND/OR DAMAGE TO THE VEHICLE.



THIS MANUAL IS SPECIFIC TO THE APRILIA RSV4 RF M.Y. 2015. THERE MAY BE SOME DIFFERENCES IN INSTALLATION PROCEDURES FOR OTHER MODELS.



AKRAPOVIČ MAKES EVERY EFFORT TO PROVIDE IMPROVED CORNERING CLEARANCE FOR EXHAUST SYSTEMS. HOWEVER, DUE TO DESIGN AND SPACE LIMITATIONS ON SOME MOTORCYCLE MODELS, GROUND AND CORNERING CLEARANCE MAY NOT IMPROVE OR MAY EVEN BE REDUCED. FOR ADVANCED USERS, WE RECOMMEND INCREASING THE SPRING PRELOAD SETTINGS TO IMPROVE GROUND CLEARANCE.



THE AKRAPOVIČ WARRANTY DOES NOT COVER DISCOLORATION OF ANY CHROME PRODUCTS.

REMOVAL OF STOCK EXHAUST SYSTEM:

1. Put the motorcycle on a side stand, we recommend a central racing stand. Make sure, that surface is solid and flat.
2. Unscrew the muffler hanging bracket bolt, loosen the clamp at the muffler-collector connection and remove the muffler off the motorcycle (Figure 1, 2).

! CAUTION: be careful not to damage any part of the motorcycle during this process!

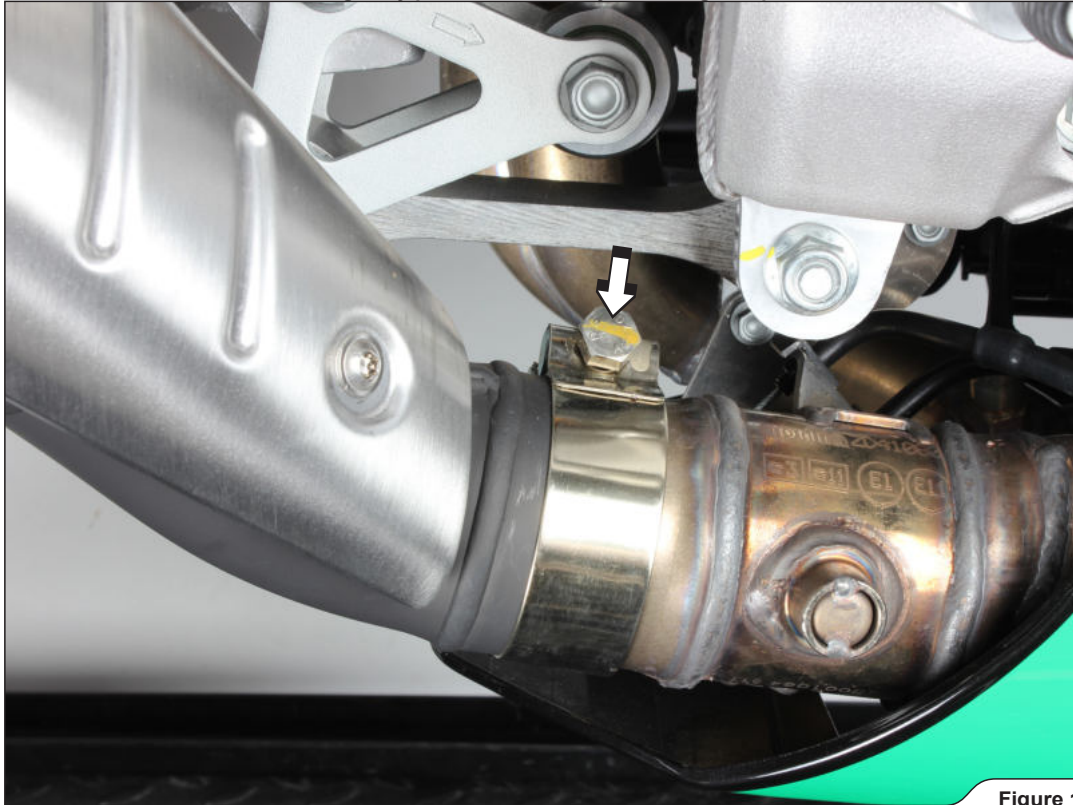

Figure 1

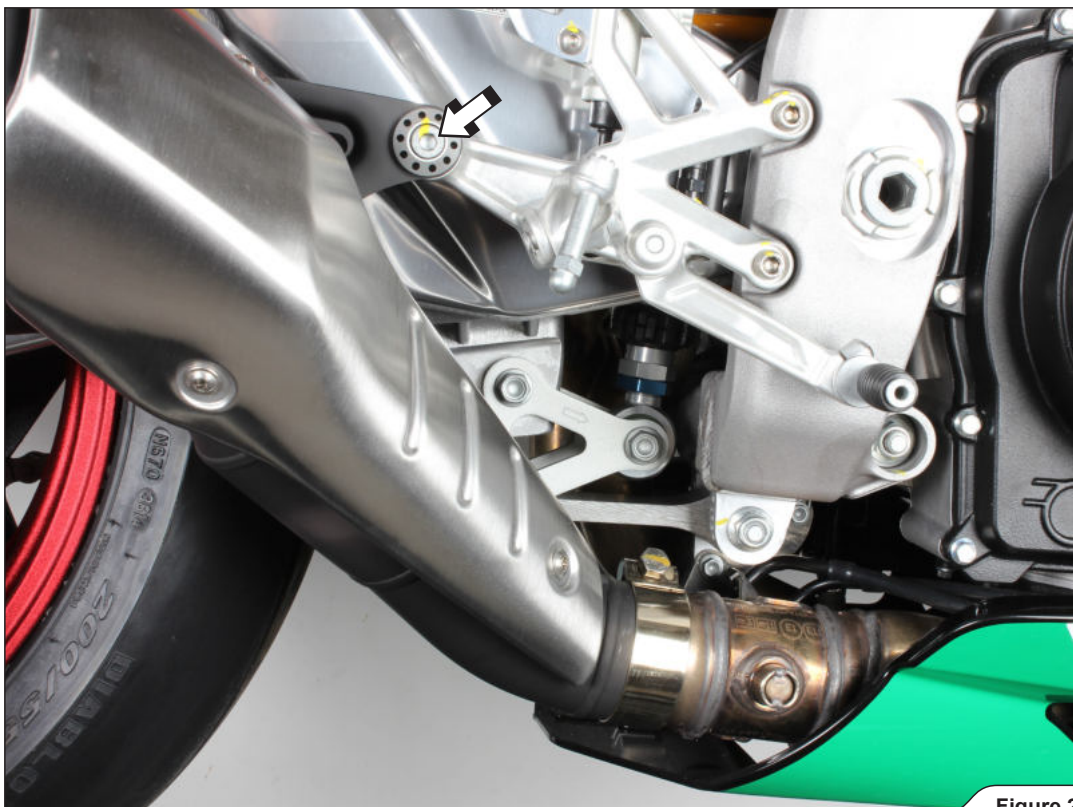

Figure 2

3. Remove the metal collar and rubber damper from the muffler hanging bracket (Figure 3, 4).
! CAUTION: be careful not to damage any part of the motorcycle during this process!

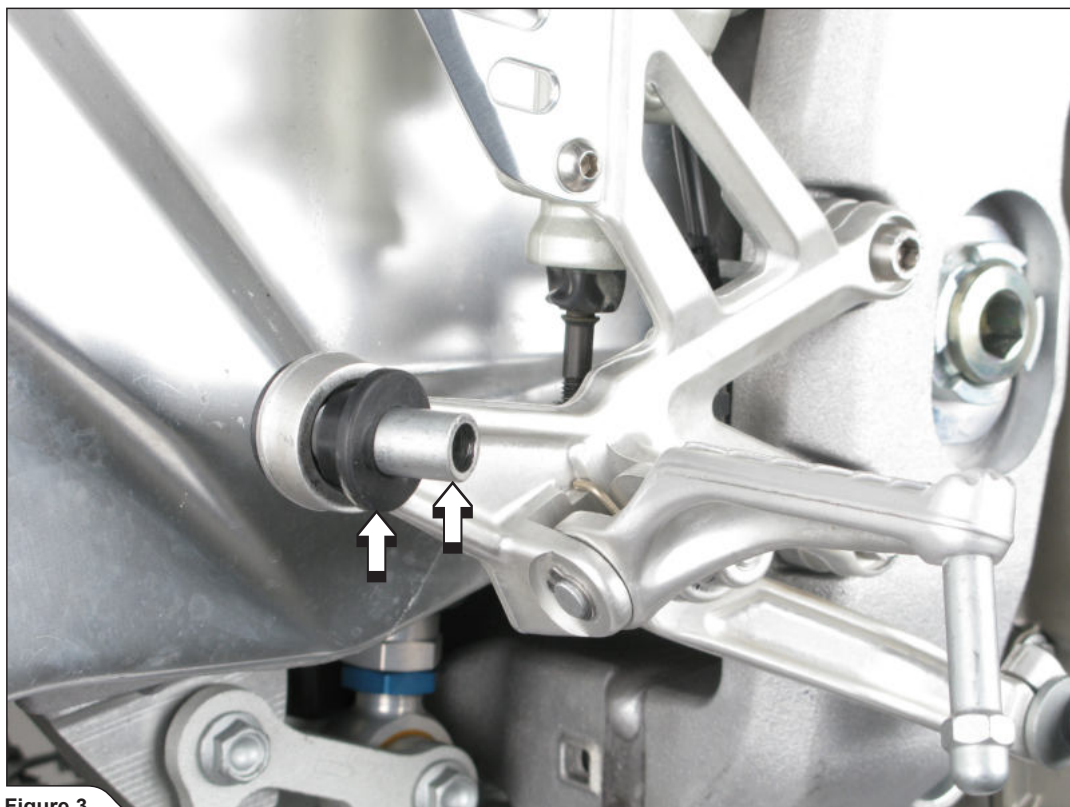

Figure 3

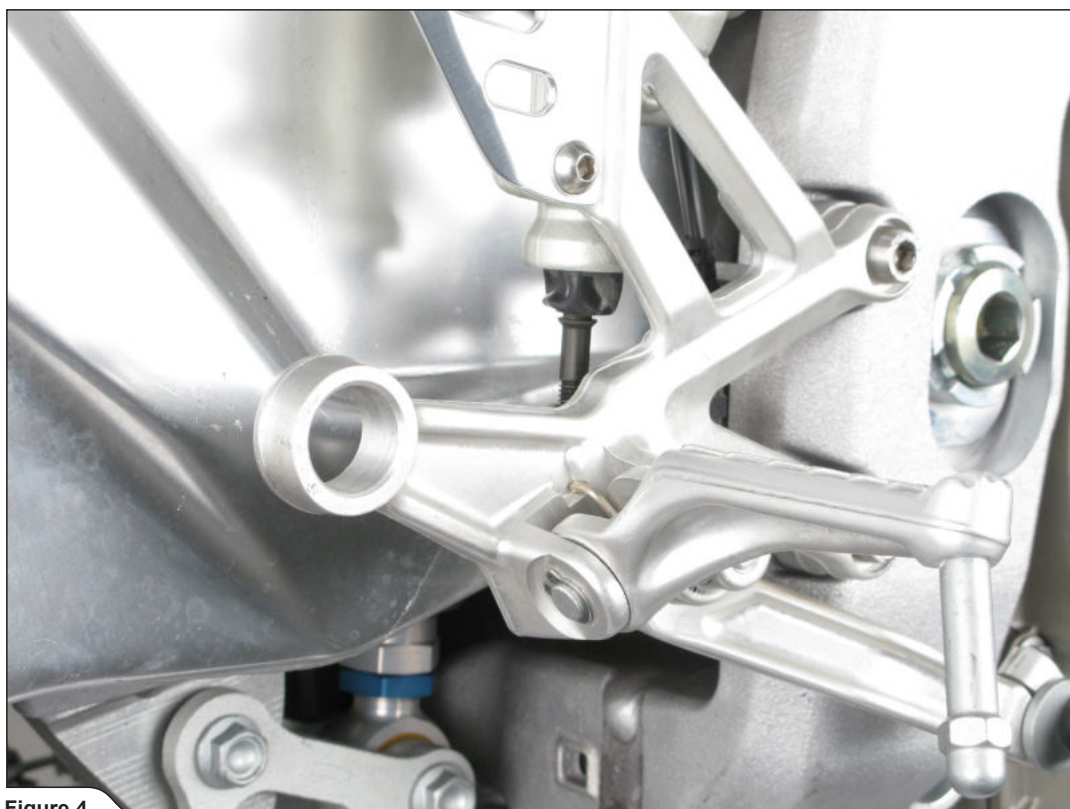

Figure 4

4. Unscrew the marked bolts, remove the plastic fasteners on both sides of the motorcycle and carefully remove the lower and middle parts of the cowling (Figure 5, 6, 7, 8).

! **CAUTION:** be careful not to injure yourself or damage any part of the motorcycle during this process!



Figure 5



Figure 6

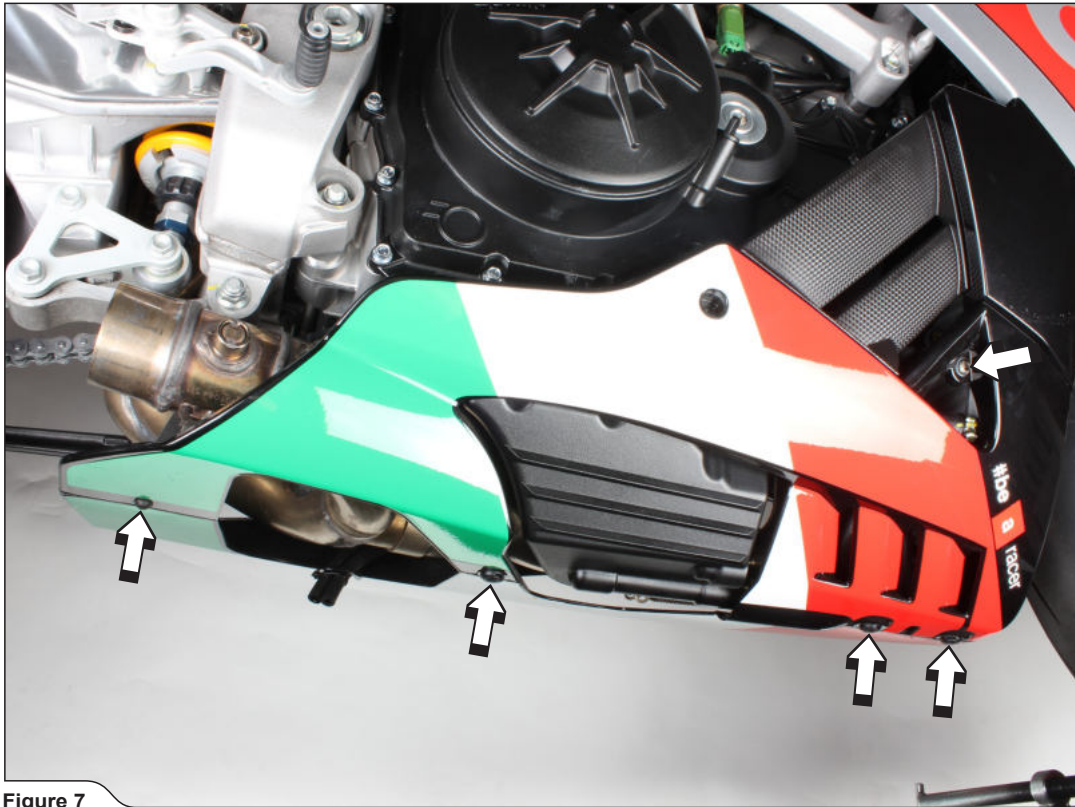

Figure 7



Figure 8

5. Unscrew the bolt, remove the stock servo motor wheel and unhook the cables of the exhaust valve (Figure 9, 10).

! **CAUTION:** do not turn the the servo motor wheel with force or the servo motor could be damaged. Hold the servo wheel in place with pliers when unscrewing!

✂ **INSTALLATION TIP:** for easier removal, loosen up the exhaust valve cable adjusters.

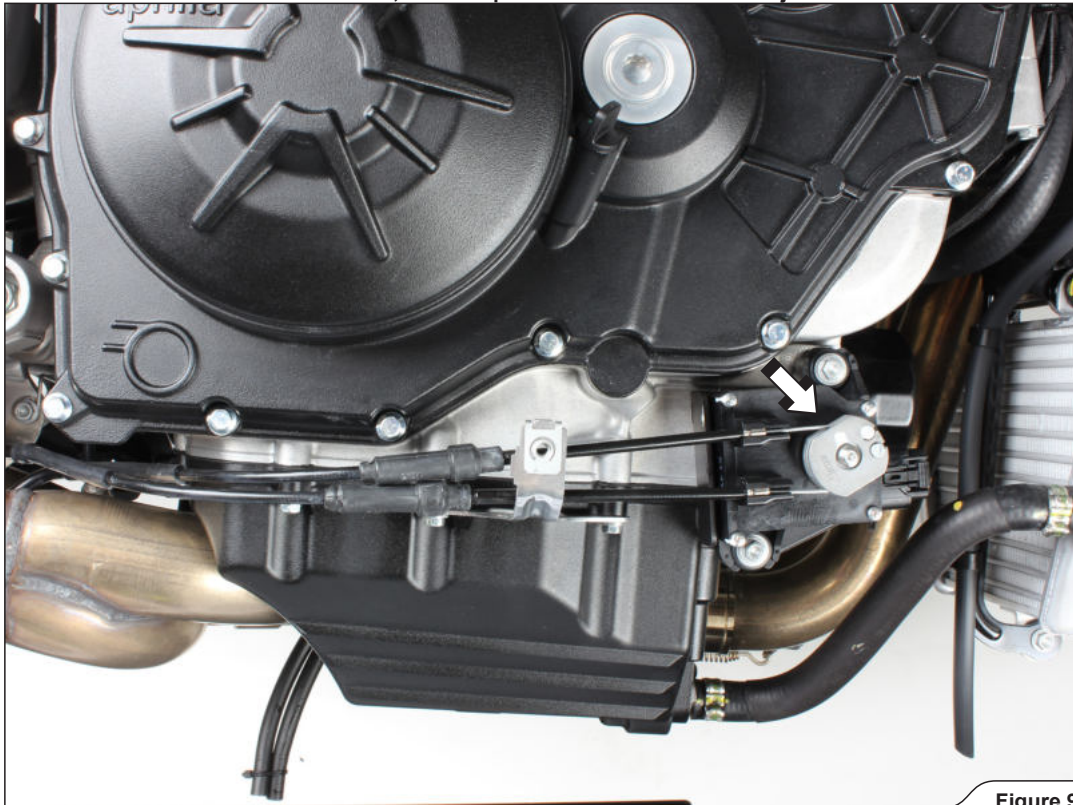

Figure 9



Figure 10

6. Reattach the servo motor wheel and tighten the bolt (Figure 11).
! CAUTION: do not disconnect or remove the servo motor off the motorcycle!

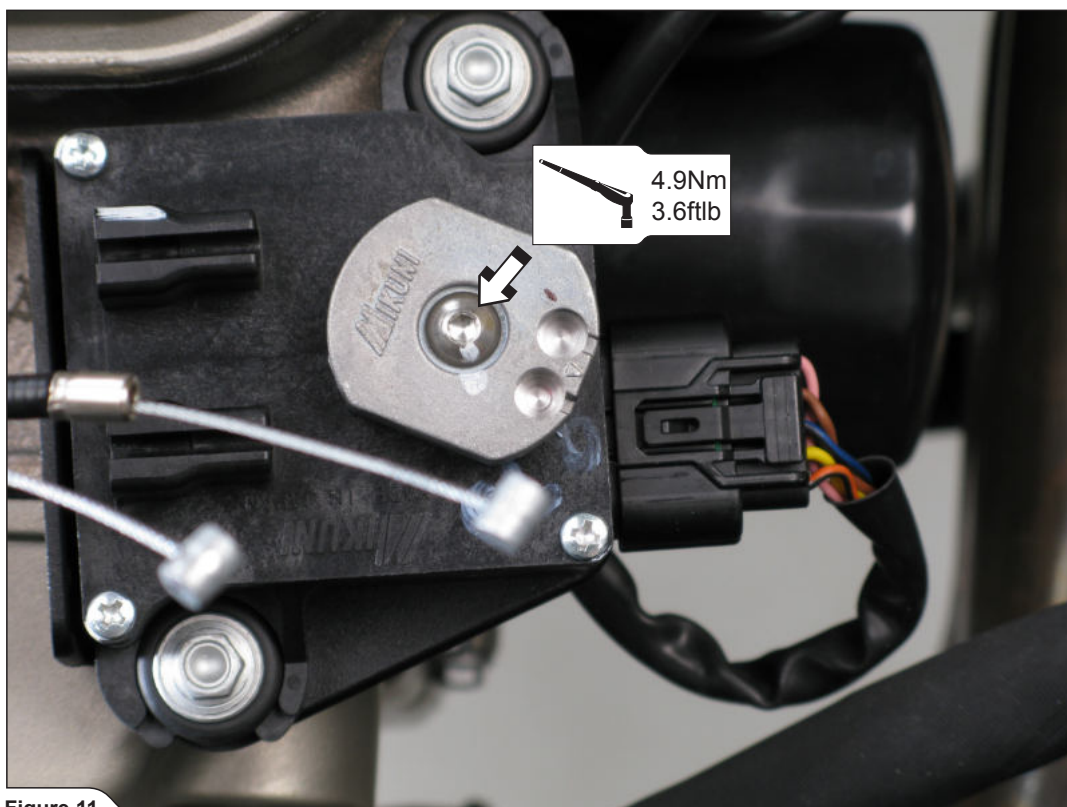

Figure 11

7. Unscrew the bolt and remove the safety pin from the oil cooler hanging brackets and move the cooler out of the way (Figure 12).
! CAUTION: be careful not to injure yourself or damage any part of the motorcycle during this process!



Figure 12

- Unhook the marked springs (Figure 13).

! CAUTION: be careful not to injure yourself or damage any part of the motorcycle during this process!

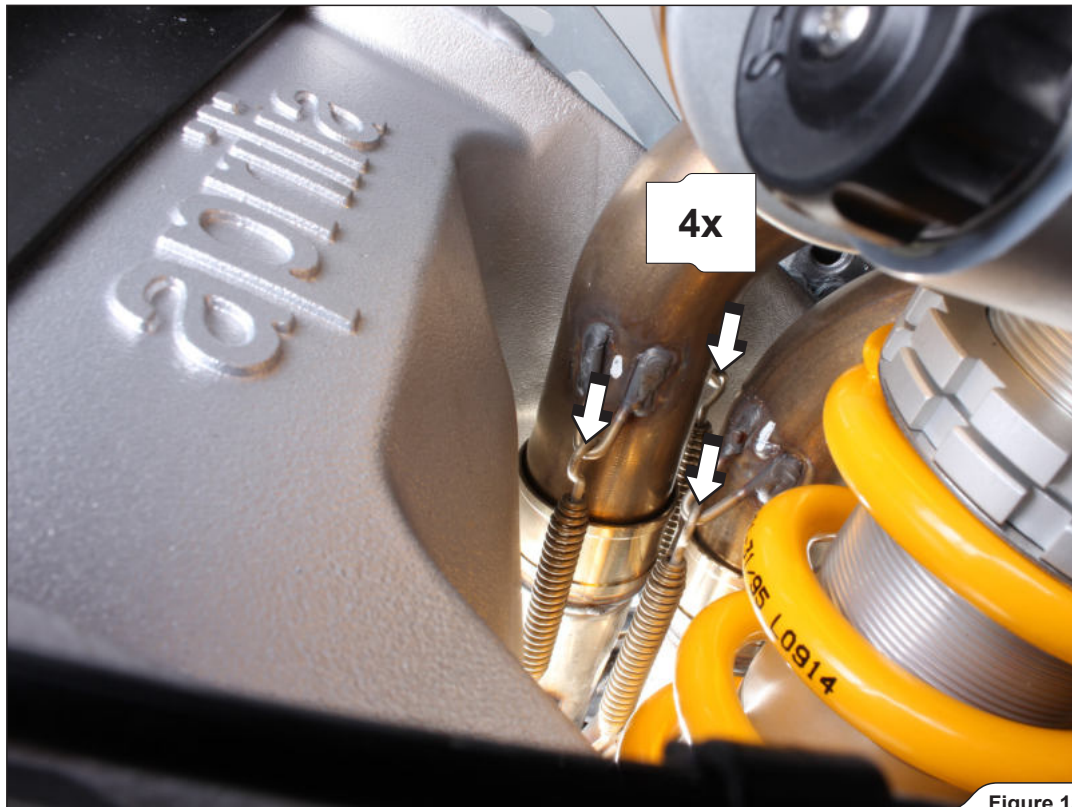

Figure 13

- Unscrew both lambda sensors, unhook the marked springs and carefully remove the collector off the motorcycle (Figure 14).

! CAUTION: make sure not to damage the lambda sensors' electrical leads during this process!

! CAUTION: be careful not to injure yourself or damage any part of the motorcycle during this process!

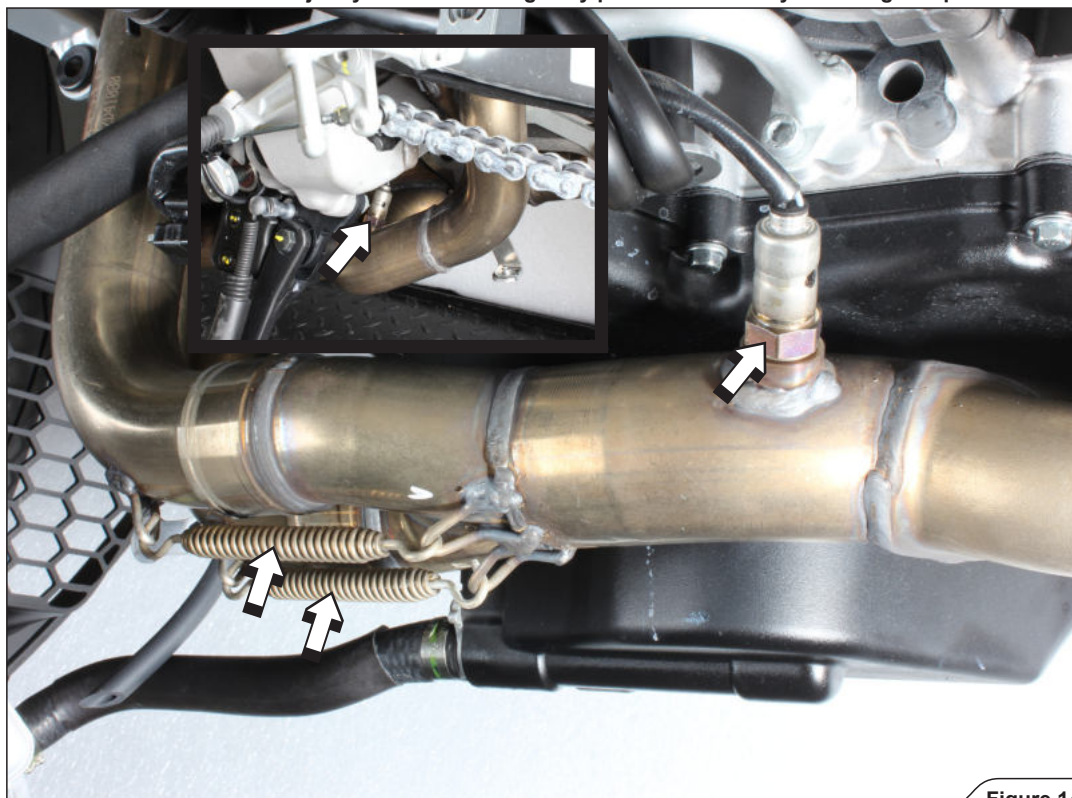

Figure 14

10. Unscrew the rear headers' flange nuts and carefully remove the headers off the motorcycle (Figure 15).
! CAUTION: be careful not to injure yourself or damage any part of the motorcycle during this process!

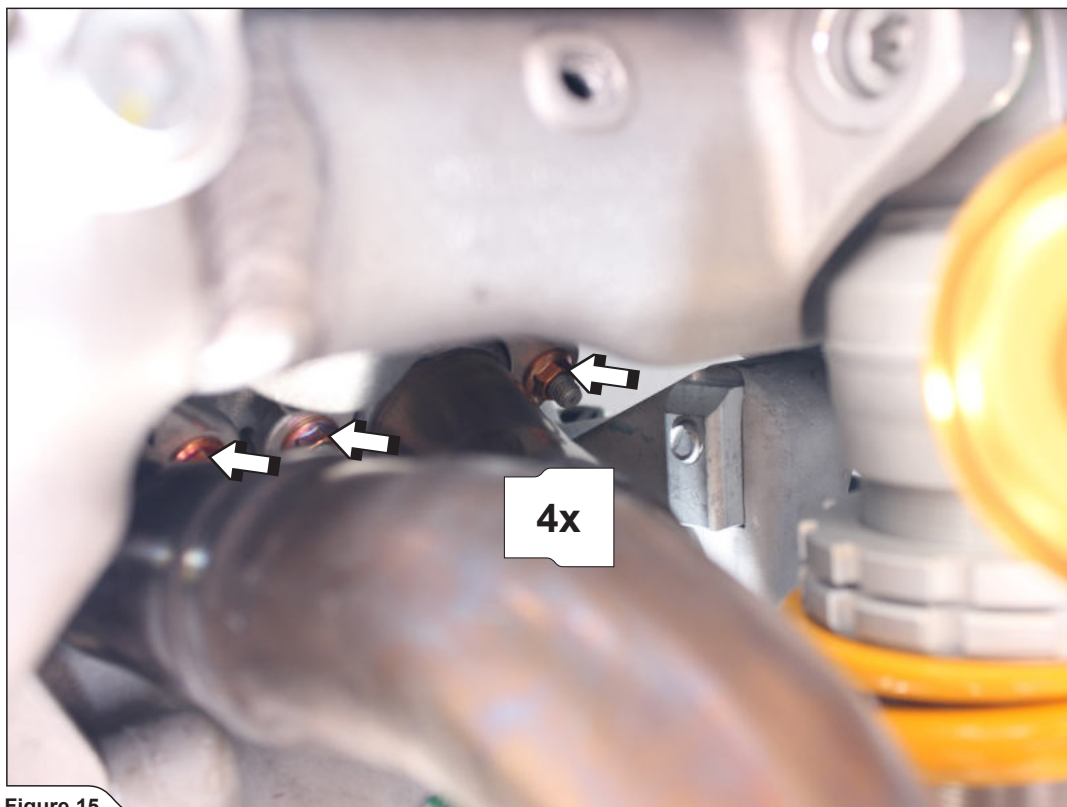

Figure 15

11. Unscrew the front headers' flange nuts and carefully remove the headers off the motorcycle (Figure 16).
! CAUTION: be careful not to damage the radiator or any other part of the motorcycle during this process!

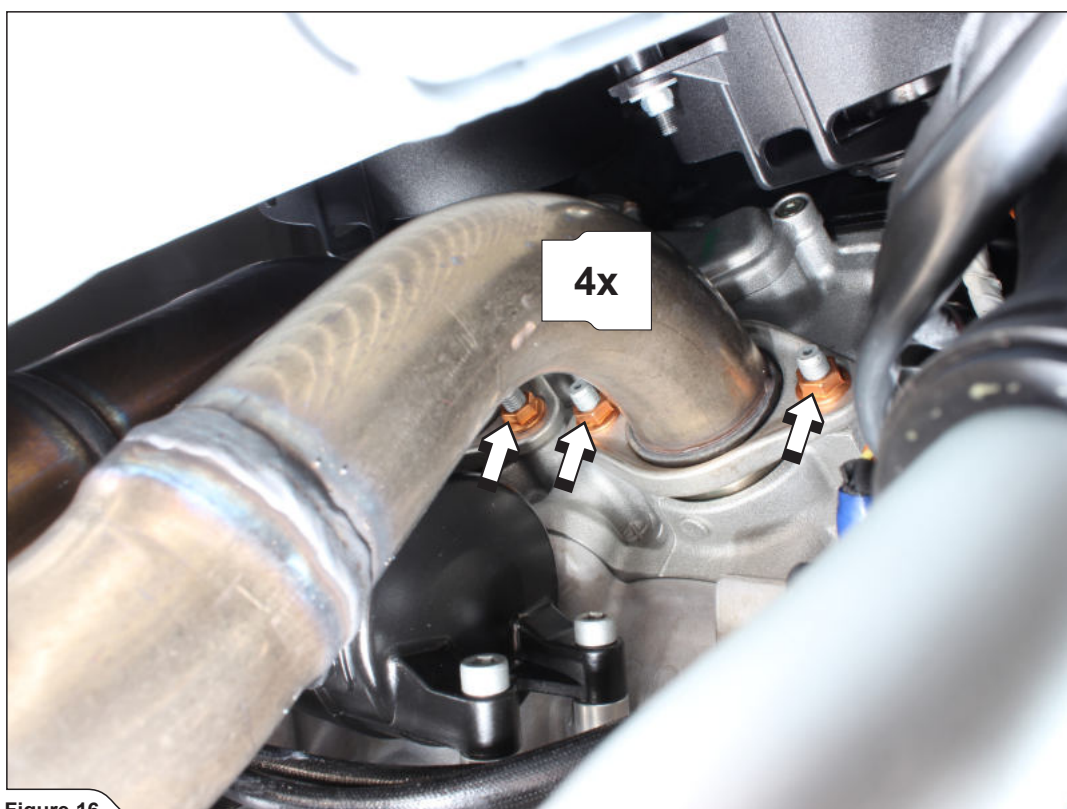

Figure 16

INSTALLATION OF THE AKRAPOVIČ EXHAUST SYSTEM:

1. Set up the flanges together with the springs and sleeves; make sure you orient the flanges and springs as shown (Figure 17).



Figure 17

2. Set up the **left rear header** with flange, spring and sleeve; make sure you orient the flange and spring as shown (Figure 18).



Figure 18

3. Set up and tighten the front headers' flanges together with the springs and sleeves onto the front cylinder head, using stock nuts; make sure you orient the flanges and springs as shown (Figure 19).

! CAUTION: be careful not to injure yourself or damage any part of the motorcycle during this process!

✂ INSTALLATION TIP: use new stock exhaust port gaskets.

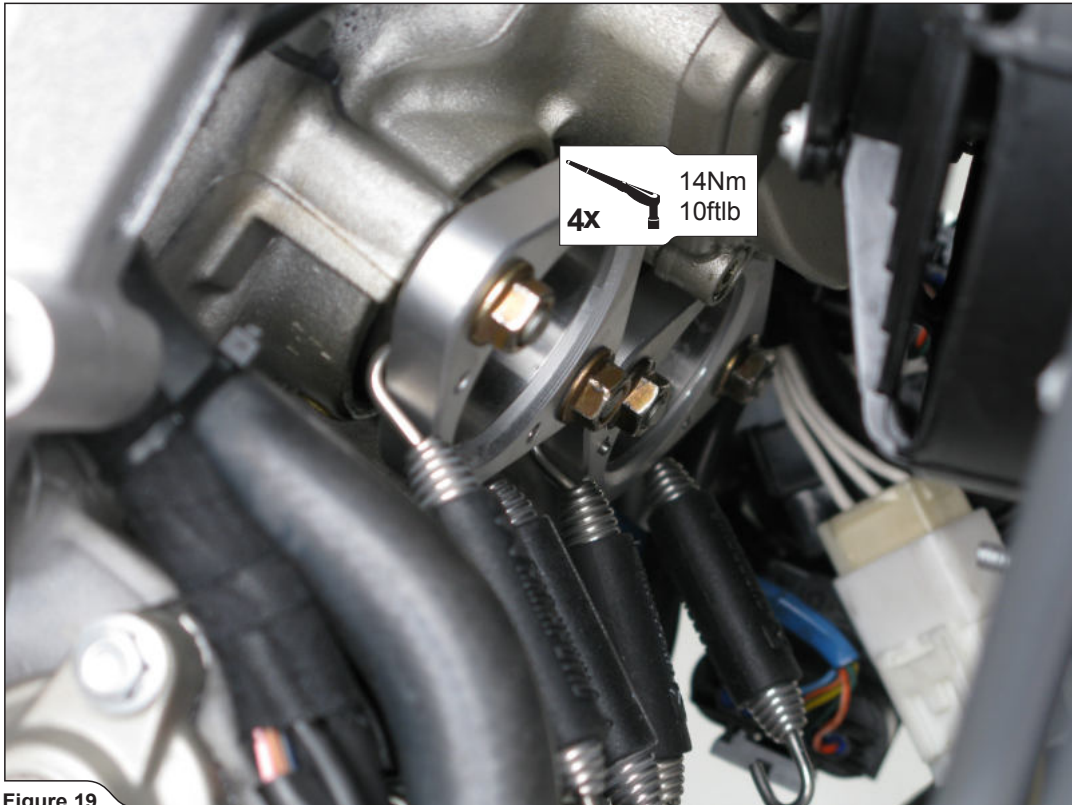

Figure 19

4. Set up and tighten the (rear right only!) header's flange together with the spring and sleeve onto the rear right cylinder head outlet, using stock nuts; make sure you orient the flange and spring as shown (Figure 20).

! CAUTION: be careful not to injure yourself or damage any part of the motorcycle during this process!

✂ INSTALLATION TIP: use new stock exhaust port gasket.

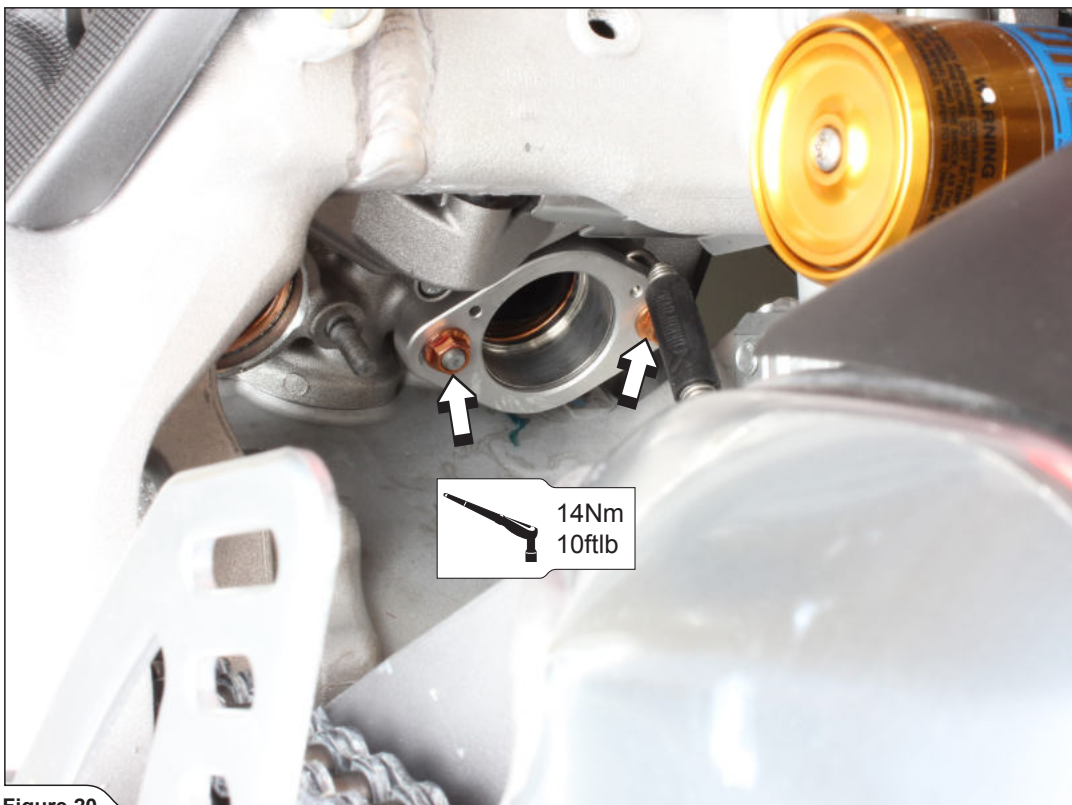

Figure 20

5. Instal the **left rear header** together with sleeve, flange and spring; tighten the flange onto the rear cylinder head, using stock nuts and attach the spring (**Figure 21**).

! CAUTION: be careful not to injure yourself or damage any part of the motorcycle during this process!

✂ INSTALLATION TIP: use new stock exhaust port gasket.

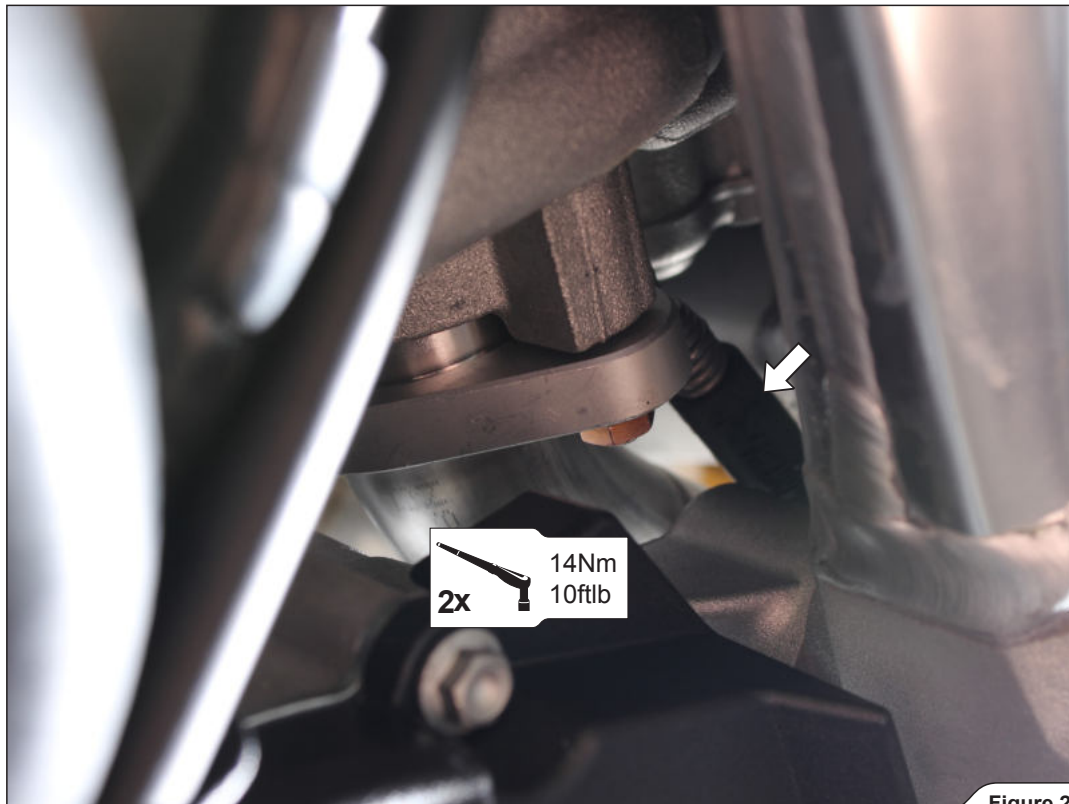

Figure 21

6. Insert the **right rear header** into the sleeve and attach the spring (**Figure 22**).

! CAUTION: make sure, that spring pull the header tube all the way into the sleeve – use rubber mallet if necessary to tap the connection into place!

! CAUTION: be careful not to injure yourself or damage any part of the motorcycle during this process!



Figure 22

7. Insert the front headers into the sleeves and attach the springs (Figure 23).

! **CAUTION:** make sure, that springs pull the header tubes all the way into the sleeves – use rubber mallet if necessary to tap the connections into place!

! **CAUTION:** be careful not to injure yourself or damage any part of the motorcycle during this process!

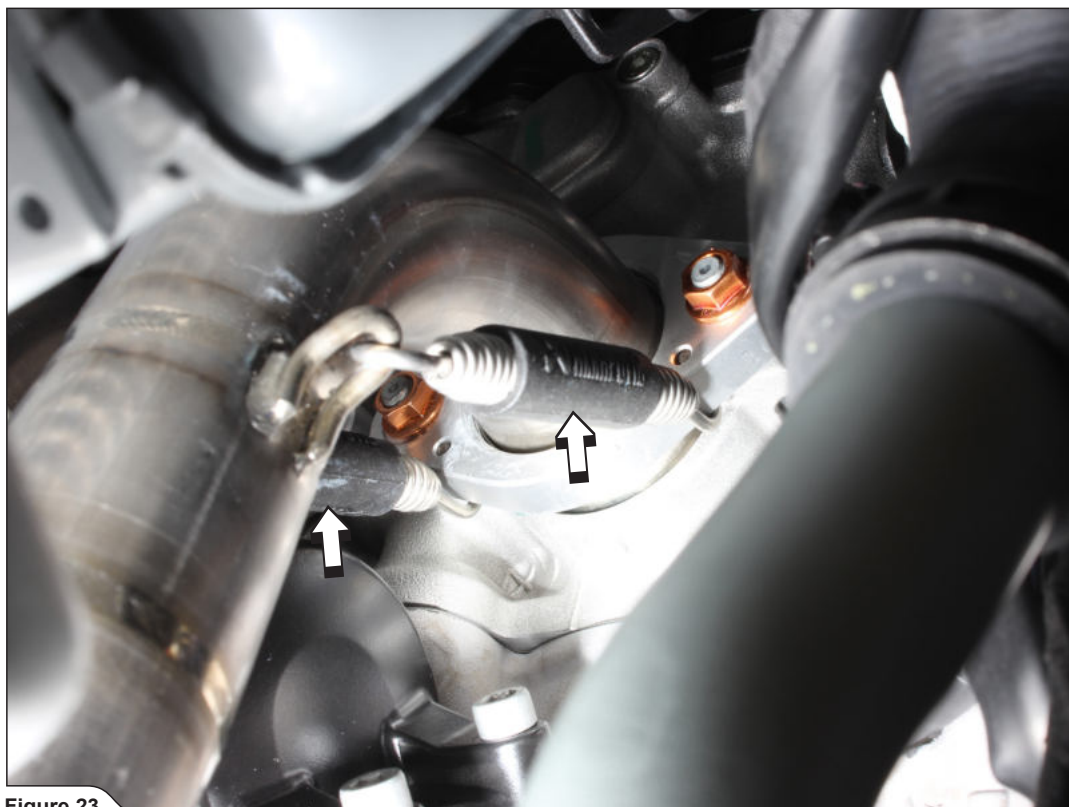

Figure 23

8. Assemble the collector onto the headers and install the lambda sensors into the collector (Figure 24).

✂ **INSTALLATION TIP:** coat the interior side of the inlet bushes of the titanium collector with Akrapovič ceramic anti-seizing grease (white tube).

✂ **INSTALLATION TIP:** use ceramic anti-seizing grease on the lambda sensor threads (white tube).

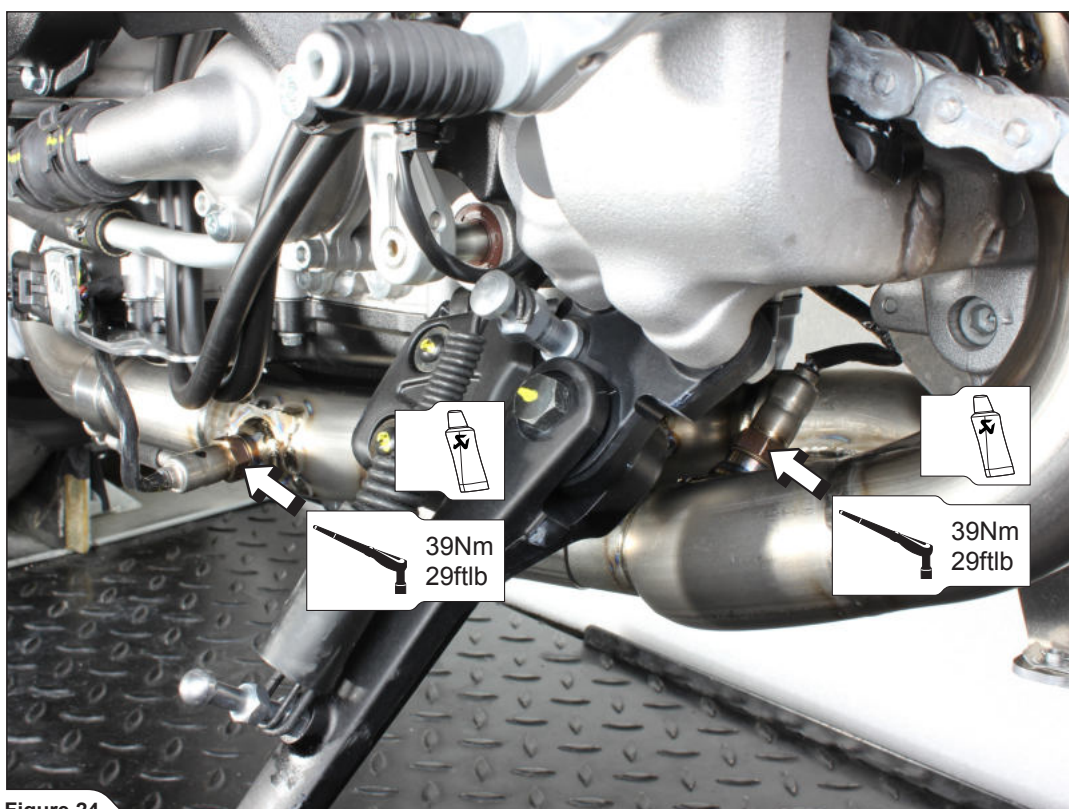

Figure 24

9. Attach the springs at the rear and front headers - collectors joints (Figure 25, 26).

! **CAUTION:** make sure, that springs pull the collector all the way onto the headers – use rubber mallet if necessary to tap the connections into place!

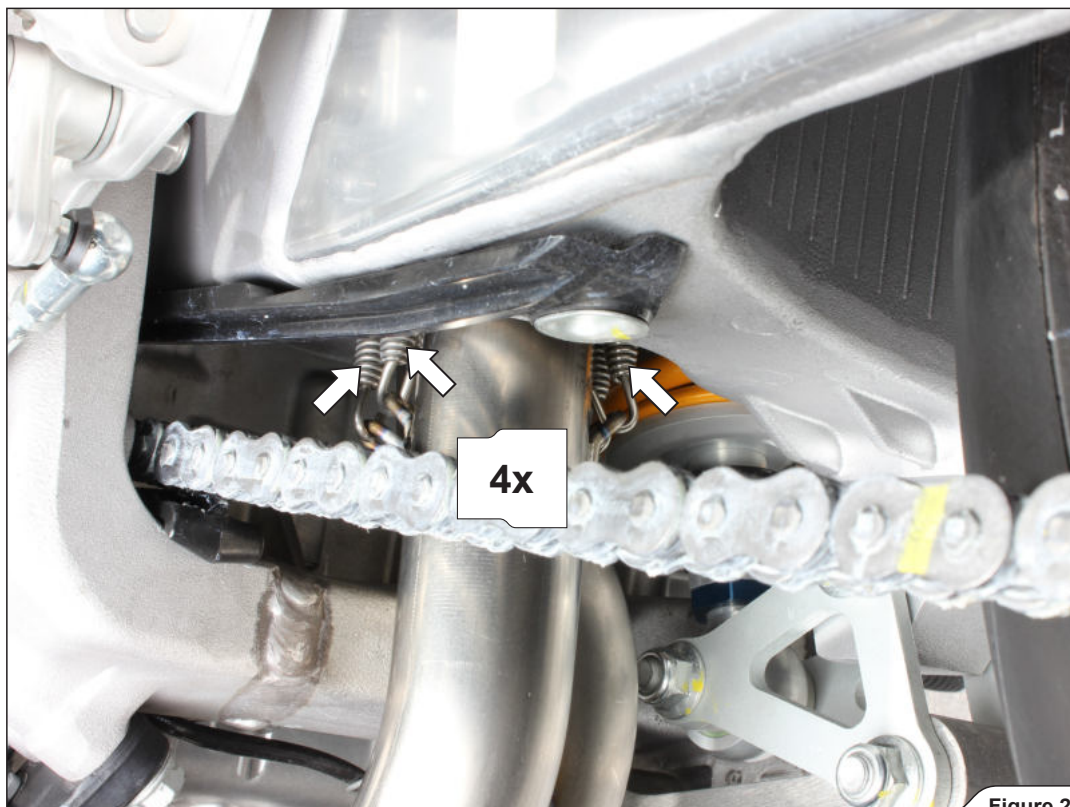

Figure 25

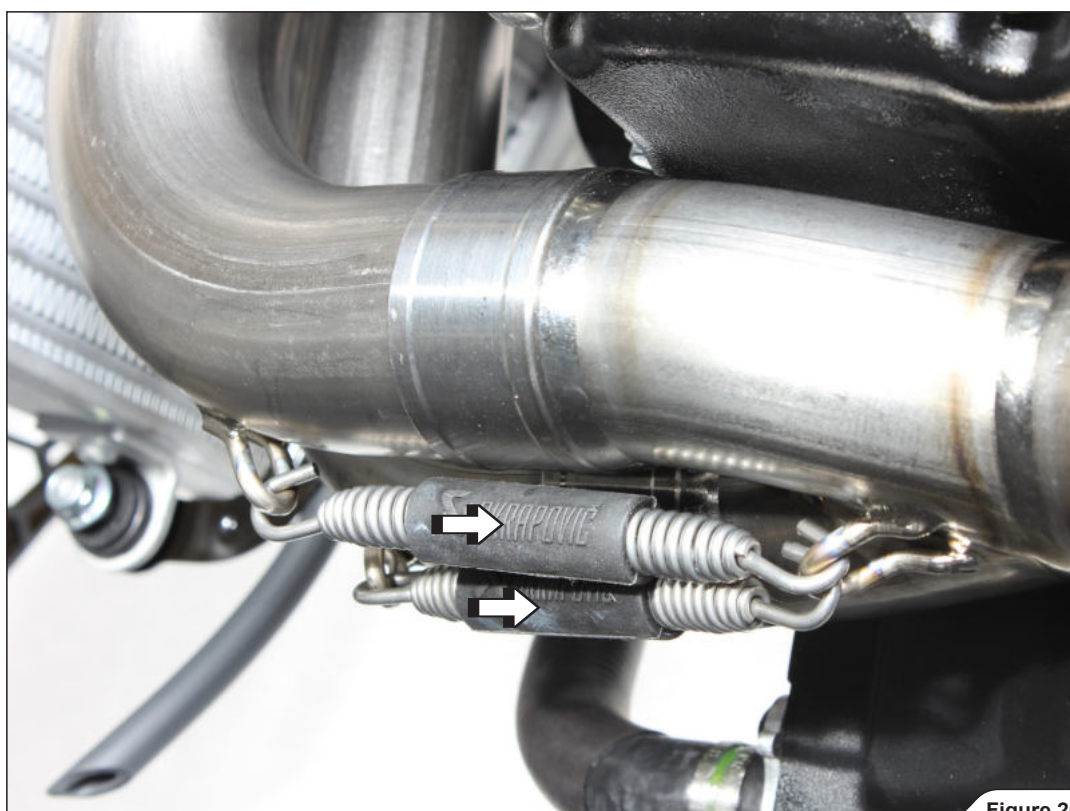

Figure 26

10. Slide the link pipe onto the collector's outlet and attach the spring (Figure 27).

! **CAUTION:** make sure, that spring pull the link pipe all the way onto the collector – use rubber mallet if necessary to tap the connection into place!

✂ **INSTALLATION TIP:** coat the interior side of the input bush of the titanium link pipe with Akrapovič ceramic anti-seizing grease (white tube).

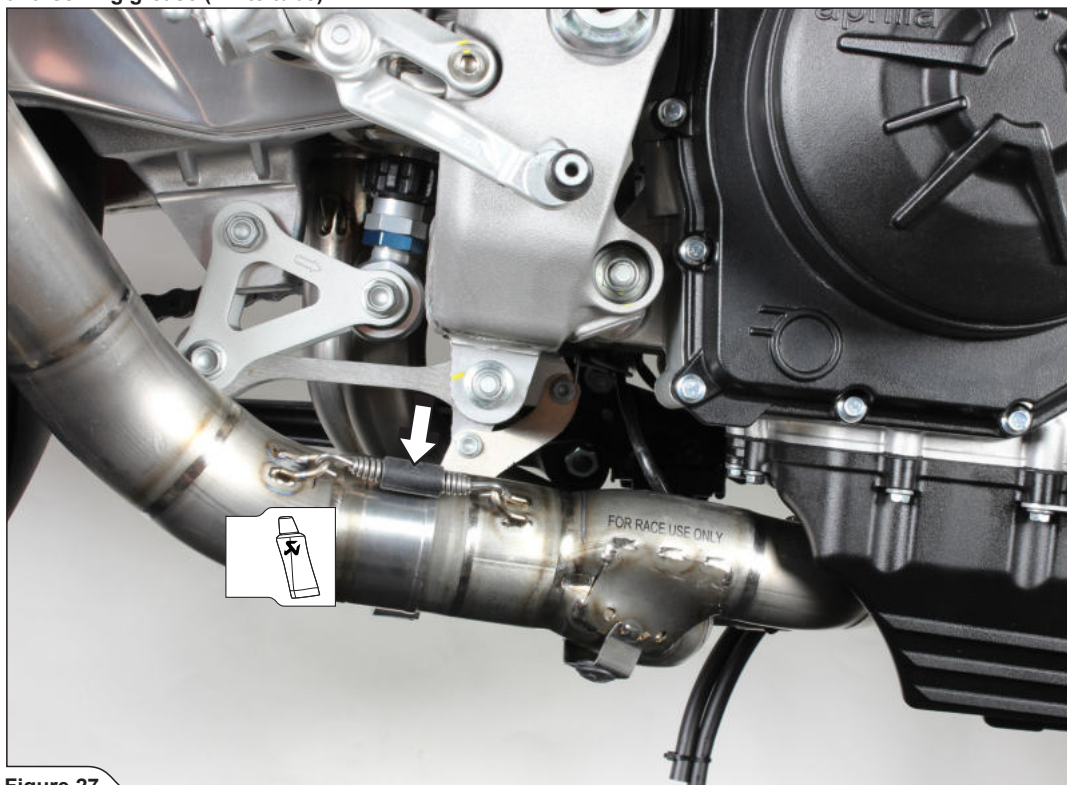

Figure 27

11. Unscrew marked bolts on both sides and remove passenger's foot rests off the motorcycle (Figure 28).

! **CAUTION:** be careful not to injure yourself or damage any part of the motorcycle during this process!



Figure 28

12. Install the Carbon Fiber Bracket onto the right side of the sub frame, using bolts, washers and Aluminium distance bushes from Akrapovič installation kit (**Figure 29**).

! **CAUTION:** use bolt sealant on the bolt threads!

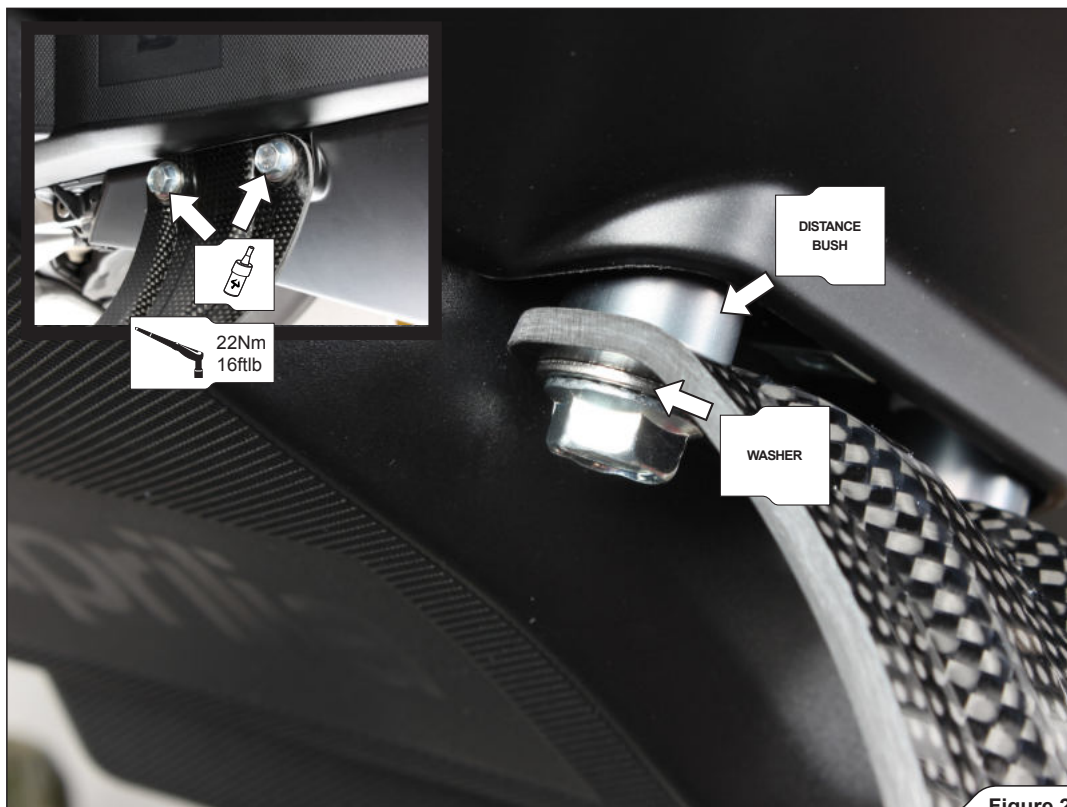

Figure 29

13. Correctly position the carbon-fiber clamp (check the position of the yellow sticker) and carefully slide it onto the muffler (**Figure 30**).

! **CAUTION:** open the carbon-fiber clamp slightly wider than the diameter of the outer sleeve of the muffler – do not scrape it along the muffler outer sleeve!



Figure 30

14. Position the muffler correctly, slide it onto the outlet of the link pipe and attach the springs (Figure 31).

! **CAUTION:** be careful not to damage the muffler or any other part of the motorcycle during this process!

✂ **INSTALLATION TIP:** coat the interior side of the inlet bushes of the muffler with Akrapovič ceramic anti-seizing grease (white tube).

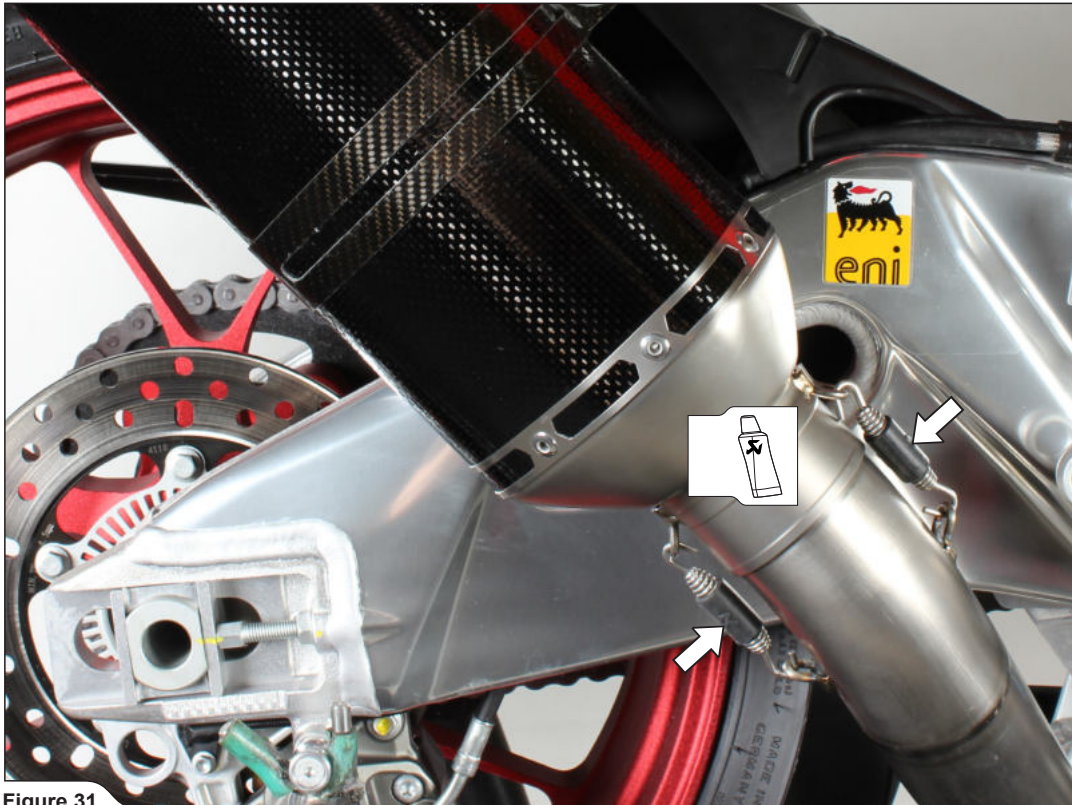

Figure 31

15. Hand tighten the carbon-fiber clamp onto the muffler's bracket, using bolt, nut and washer from installation kit and stock Aluminium washer (Figure 32).

! **CAUTION:** be careful not to damage the exhaust or any other part of the motorcycle during this procedure!

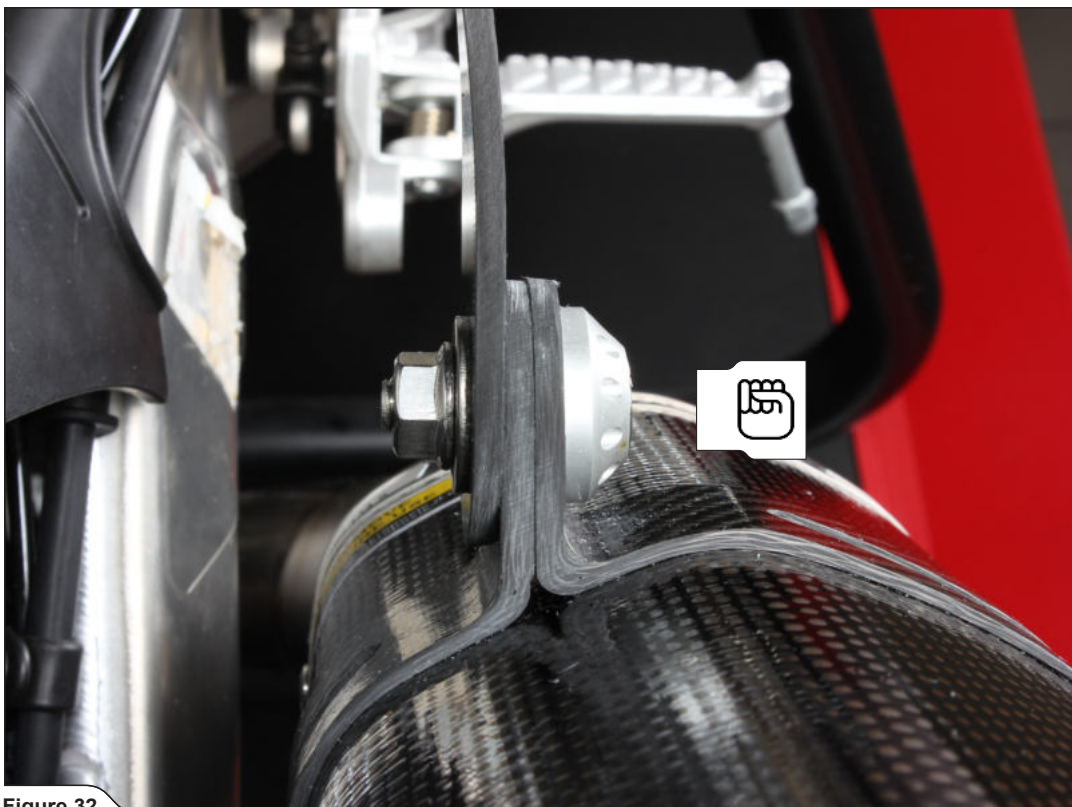

Figure 32

16. Align the muffler in respect to the motorcycle and tighten the muffler's bracket bolt to the specified torque (Figure 33).

! **CAUTION:** be careful not to damage the exhaust or any other part of the motorcycle during this procedure!

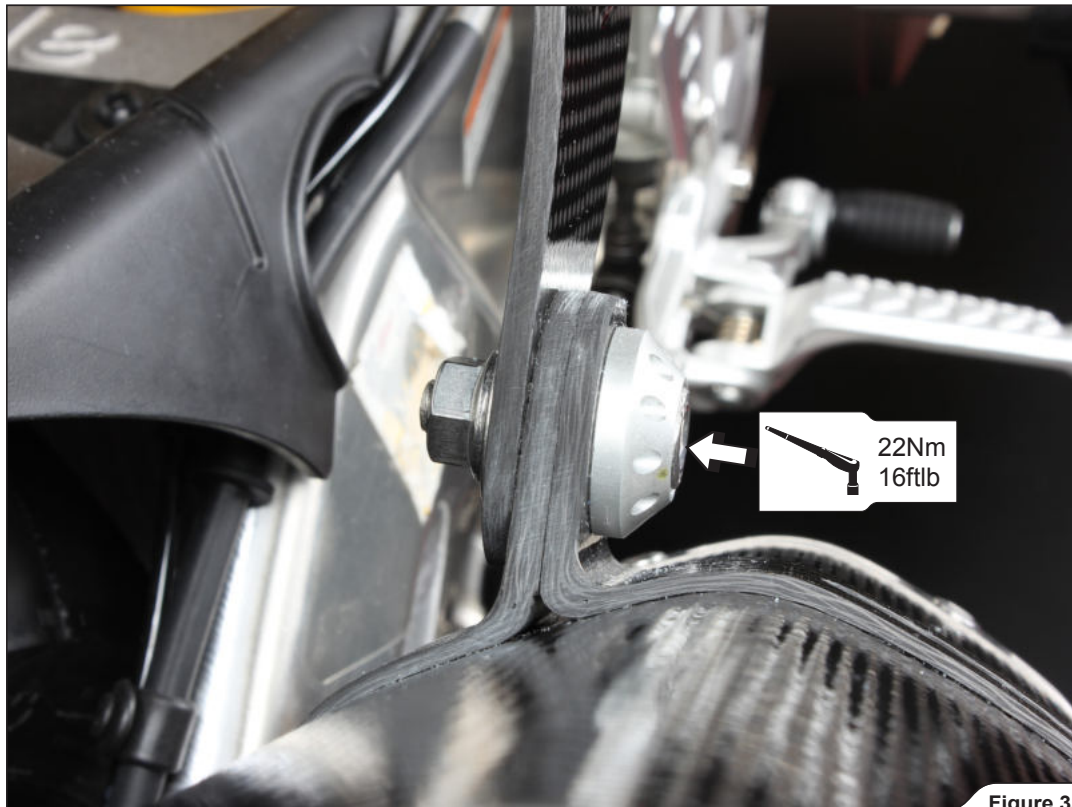

Figure 33

17. Reinstall all dismantled stock parts and cowlings in the reverse order from the order in which they were removed (Figure 34).

✂ **INSTALLATION TIP:** check vehicle manufacturer manual for tightening torques!

! **CAUTION:** be careful not to damage any part of the motorcycle during this process!



Figure 34

Final installation:

Clean grease spots:

- a. Muffler – titanium outer sleeve: use a soft cloth sprayed with a multi-purpose spray lubricant (WD-40 or equivalent).
- b. Muffler – carbon-fiber outer sleeve: use a soft dry cloth.
- c. Muffler – carbon-fiber outlet cap: use a soft dry cloth.
- d. Stainless steel pipes: use a soft cloth sprayed with a contact cleaner, then wipe with a soft dry cloth.
- e. Chrome plated parts: use a soft dry cloth.
- f. Titanium pipes: use a soft cloth sprayed with a multi-purpose spray lubricant (WD-40 or equivalent).

Cleaning will prevent spots from burning onto the surface. Do not use aggressive chemical cleaners, because they can damage the sticker.

! WARNING: make sure all the bolts are sufficiently tightened. In case the exhaust system touches the cowling or other parts repeat the adjustment of the exhaust system or contact your authorized dealer.

! WARNING: after running engine for 30 minutes, retighten the bolts of the Akrapovic carbon-fiber heat shield!

! IT IS NORMAL IF WHITE SMOKE COMES OUT OF THE MUFFLER ON FIRST OPERATION.

! DO NOT STAND BEHIND THE MUFFLER ON FIRST OPERATION.

! DO NOT USE AUTOMOTIVE WHEEL CLEANERS OR ANY CLEANING PRODUCTS WHICH CONTAIN ACIDIC ADDITIVES TO CLEAN AKRAPOVIČ EXHAUST SYSTEMS.

MAINTENANCE OF THE AKRAPOVIČ EXHAUST SYSTEM:

1. Clean the titanium exhaust components with a multi-purpose spray lubricant (WD-40 or equivalent), carbon fiber exhaust components with soft and dry cloth and stainless steel components with soft cloth sprayed with contact cleaner, then wipe with soft and dry cloth. A change in the color of the exhaust system is normal due to the high temperatures.
2. Periodically make sure all the bolts and springs are sufficiently tight.

WARNING:

Please note that certain aftermarket exhaust systems may not comply with applicable California laws and regulations, and may therefore be prohibited for use on California highways or roads, or on roads or vehicles otherwise subject to emissions control requirements.

Akrapovič exhaust systems for automobiles and motorcycles mounted downstream of the catalytic converter (also known as “cat-back systems”) are considered “replacement parts” in California by the California Air Resources Board (CARB), and do not require an exemption or executive order from CARB to be sold in California. However, California prohibits the use of any aftermarket exhaust system that modifies, removes or replaces original equipment catalysts, unless CARB has issued an Executive Order as to such part or system.

Further, Akrapovič parts or exhaust systems used or intended for use on “racing vehicles” (i.e. a competition vehicle used exclusively for competition on closed-course circuits) do not require an exemption or Executive Order from CARB to be sold in California. However, such parts are prohibited from use on California public highways or roads, even if occasionally used “off-road.”

